

SP 2 B 12 R-A-10

71808

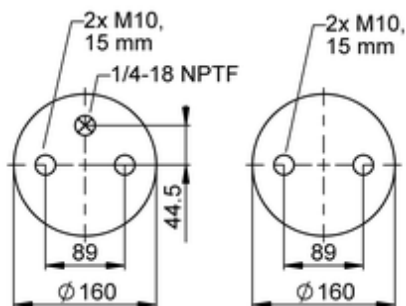

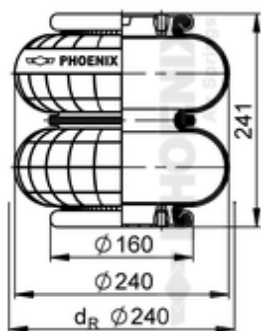



● bolt or stud

○ hole

⊗ combination stud

⊗ air inlet

	3 kg
	10002499
	K023
	G1/4: max. 35 Nm
	M10: max. 35 Nm

OE Manufacturer/Part No.

Manufacturer	Original Part No.	Model
Daimler TAS	946 328 16 01	
Meritor	2122 1356	
Weweler	YP07394F	
Weweler	US 07394C	
Schmitz	016 808	
Granning	15670	
Weweler	US 07394F	

Weweler	US 07394	AC 173
Daimler TAS	A 946 328 16 01	DCA; DLS
Valx	81005002	HD100