

1 KF 24-9

72577

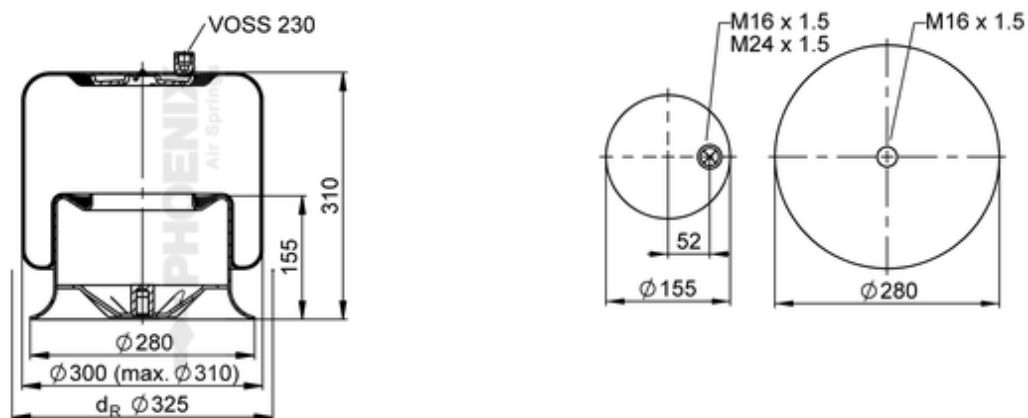







● bolt or stud

○ hole

⊗ combination stud

⊗ air inlet

	8 kg
	10002915
	K021
	
	M16x1.5: max. 130 Nm
	M24x1.5: max. 100 Nm

OE Manufacturer/Part No.

Manufacturer	Original Part No.	Model
Mercedes	974 320 02 17	
Mercedes	974 320 04 17	
Mercedes	A 974 320 04 17	Actros, Atego
Mercedes	A 974 320 02 17	Actros, Atego

