

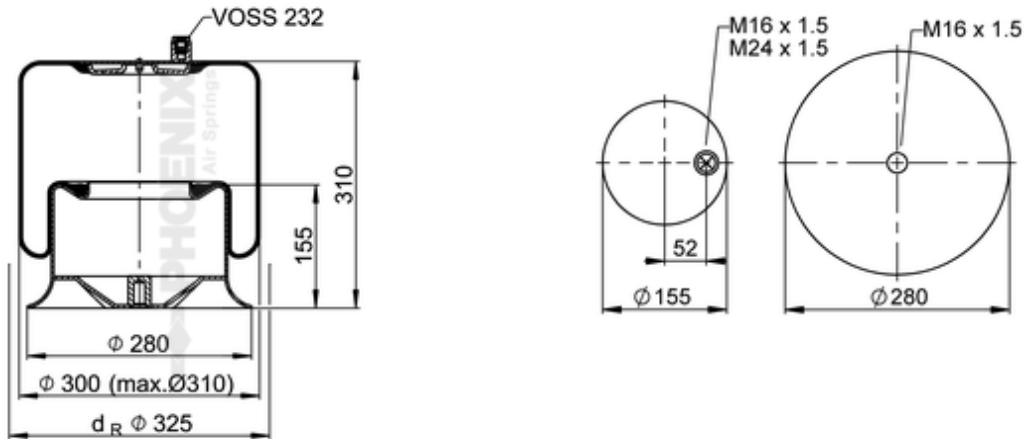





1 KF 24-29

72617



● bolt or stud ○ hole ⊗ combination stud ⊗ air inlet

 kg	8 kg
	10002936
	K021
	
	M16x1.5: max. 130 Nm
	M24x1.5: max. 100 Nm

OE Manufacturer/Part No.

Manufacturer	Original Part No.	Model
Mercedes	942 320 32 21	
Mercedes	A 942 320 32 21	Actros, Atego