

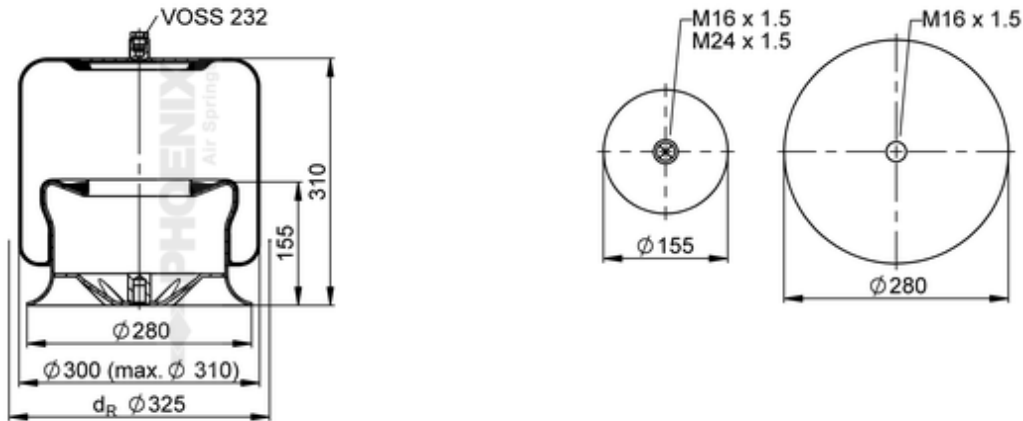





1 KF 24-21

72616



● bolt or stud ○ hole ⊗ combination stud ⊗ air inlet

 kg	7,4 kg
	10002935
	K021
	
	M16x1.5: max. 130 Nm
	M24x1.5: max. 100 Nm

OE Manufacturer/Part No.

Manufacturer	Original Part No.	Model
Mercedes	942 320 43 21	
Mercedes	A 942 320 43 21	Actros