

1 D 28 H-17 NP

76825

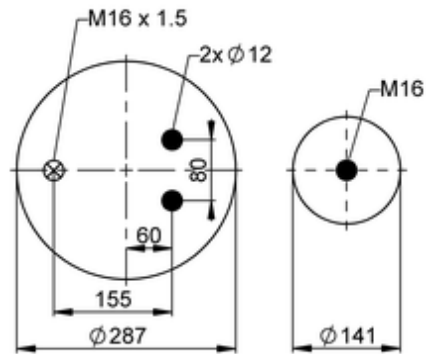

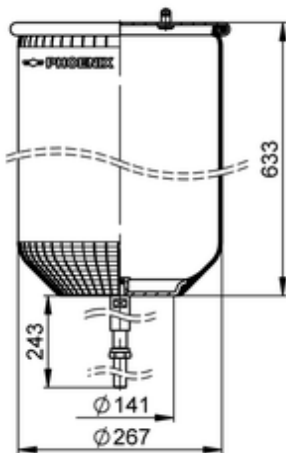



● bolt or stud

○ hole

⊗ combination stud

⊗ air inlet

Article status	Not Available
GTIN/EAN	4054389126536
Bellow number	1 D 28 H
 kg	4,5 kg
	10003278
	K004
	M16: max. 130 Nm
	M16x1.5: max. 20 Nm

OE Manufacturer/Part No.

Manufacturer	Original Part No.	Model
--------------	-------------------	-------

