

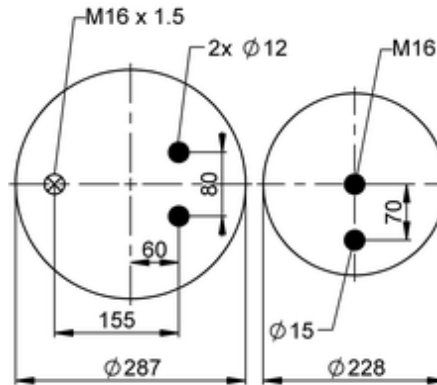

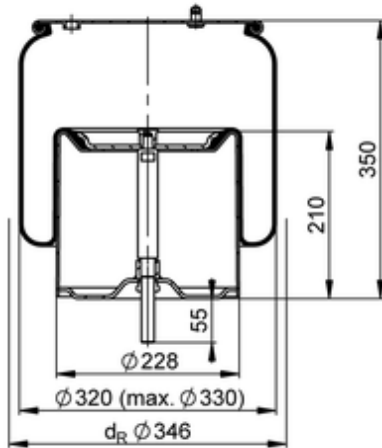



1 D 28 H-17

76824



● bolt or stud ○ hole ⊗ combination stud ⊗ air inlet

Article status	Normal
GTIN/EAN	4054389126529
Bellow number	1 D 28 H
 kg	10,6 kg
	10003277
	K004
	
	M16: max. 130 Nm
	M16x1.5: max. 20 Nm

OE Manufacturer/Part No.

Manufacturer	Original Part No.	Model
--------------	-------------------	-------

Scania	2808412	
Scania	2357460	
Scania	1944314	R-Series new generation
Scania	1774804	Scania P,R,T
Scania	2198915	Scania P,R,T
Scania	1903608	Scania P,R,T
Scania	2357532	Scania P,R,T