

1 D 28 H-16 NP

71332

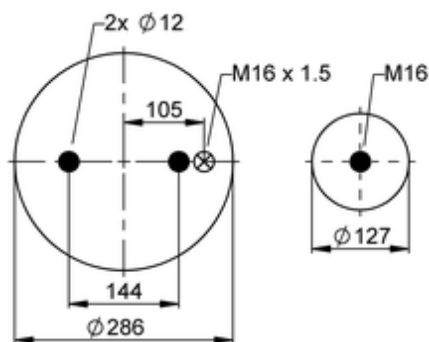

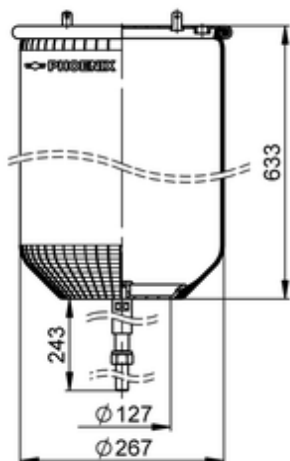



● bolt or stud

○ hole

⊗ combination stud

⊗ air inlet

Article status	Not Available
GTIN/EAN	4054389105418
Bellow number	1 D 28 H
 kg	6,4 kg
	10002082
	K004
	M16: max. 70 Nm
	M16x1.5: max. 50 Nm

OE Manufacturer/Part No.

Manufacturer	Original Part No.	Model
Scania	1379393	Series 4

