

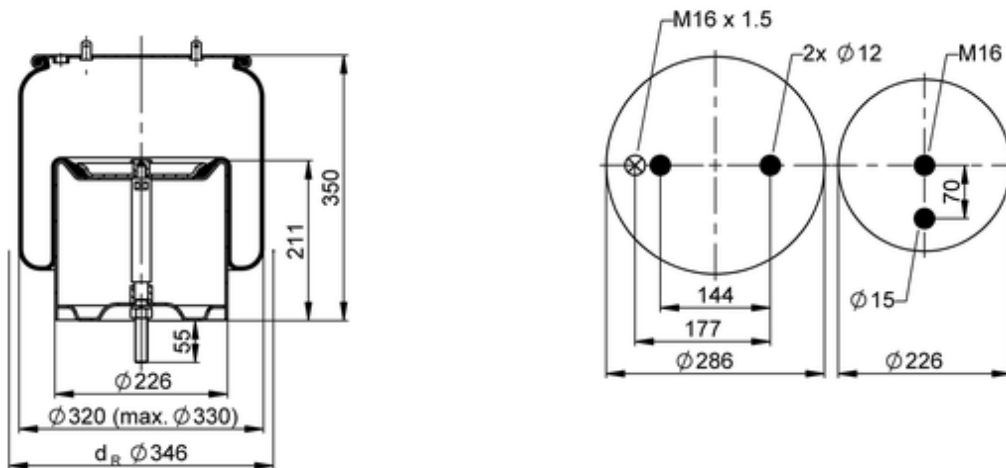





1 D 28 H-16

71331



● bolt or stud ○ hole ⊗ combination stud ⊗ air inlet

Article status	Normal
GTIN/EAN	4054389105401
Bellow number	1 D 28 H
 kg	12,3 kg
	10002081
	K004
	
	M16: max. 130 Nm
	M16x1.5: max. 20 Nm

OE Manufacturer/Part No.

Manufacturer	Original Part No.	Model
--------------	-------------------	-------

Scania	1543691	R-Series new generation
Scania	1440294	Series 4
Scania	1379392	Series 4