

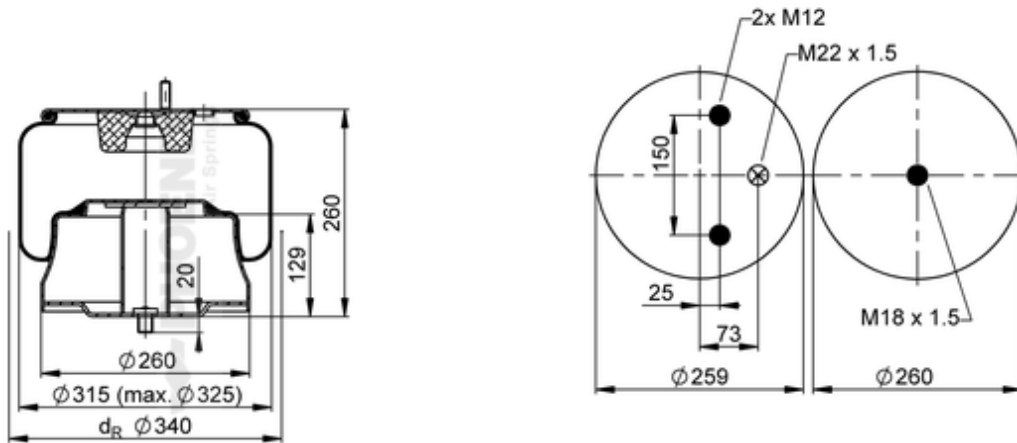





1 DF 25 A-31

55076



● bolt or stud      ○ hole      ⊗ combination stud      ⊗ air inlet

	9,8 kg
	10006761
	
	M12: max. 70 Nm
	M18x1.5: max. 130 Nm
	M22x1.5: max. 20 Nm

OE Manufacturer/Part No.

Manufacturer	Original Part No.	Model
Solaris	0004-012-361	