

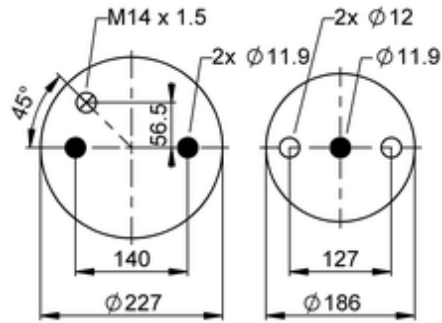

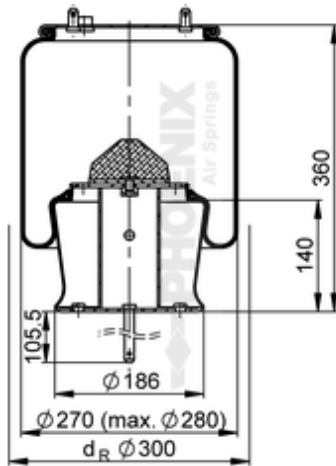



1 DF 20 A-3

72064



-  bolt or stud
-  hole
-  combination stud
-  air inlet

	8,1 kg
	10002643
	K031
	
	M14x1.5: max. 20 Nm

OE Manufacturer/Part No.

Manufacturer	Original Part No.	Model
Scania	1440304	ADA1300, ASA1300