

1 DF 20 A-2

72063

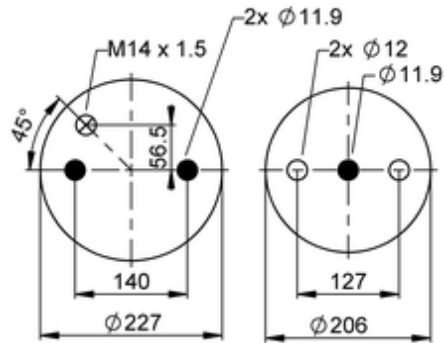

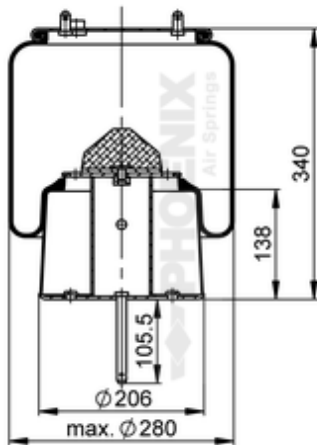



● bolt or stud

○ hole

⊗ combination stud

⊗ air inlet

	8,3 kg
	10002642
	K031
	
	M14x1.5: max. 20 Nm

OE Manufacturer/Part No.

Manufacturer	Original Part No.	Model
Scania	1440305	ADA1300