

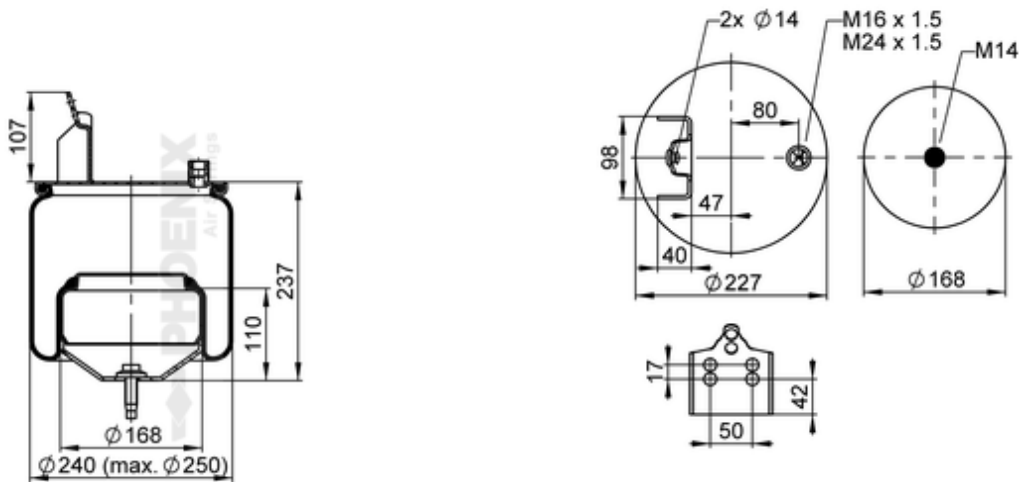





1 DF 17 C-1

600938



● bolt or stud ○ hole ⊗ combination stud ⊗ air inlet

	5,7 kg
	10003706
	K005
	
	M14: max. 120 Nm
	M24x1.5: max. 60 Nm

OE Manufacturer/Part No.

Manufacturer	Original Part No.	Model
Volvo	1 076 420	
Volvo	20 374 512	
Volvo	20 531 989	
Volvo	20 456 160	
Volvo	21 961 448	FM / FH low

Volvo

20 582 213

FM / FH low