

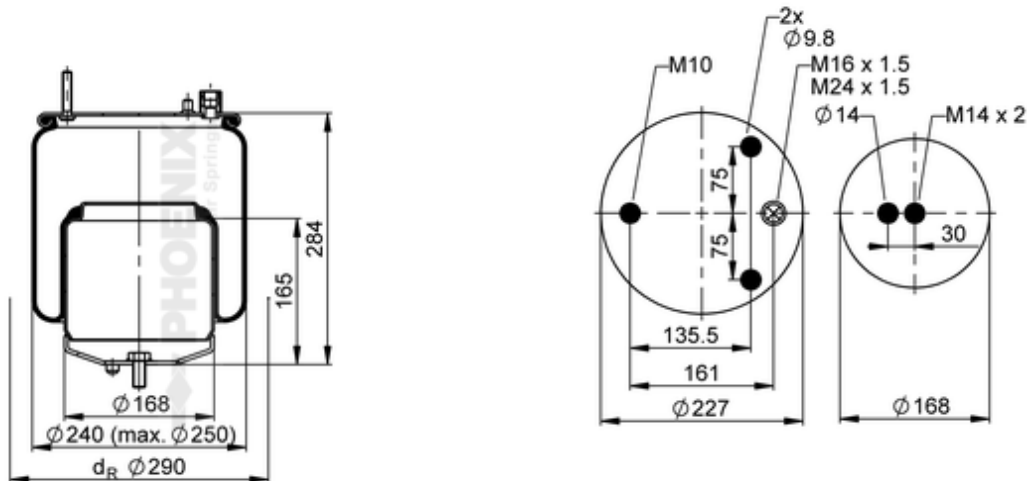







1 DF 17 A-2

600783



● bolt or stud ○ hole ⊗ combination stud ⊗ air inlet

 kg	5,8 kg
	10003661
	
	M10: max. 40 Nm
	M14: max. 120 Nm
	M16x1.5: max. 20 Nm
	M24x1.5: max. 60 Nm

OE Manufacturer/Part No.

Manufacturer	Original Part No.	Model
Volvo	22 056 630	FM / FH medium
Volvo	21 224 750	FM / FH medium

