

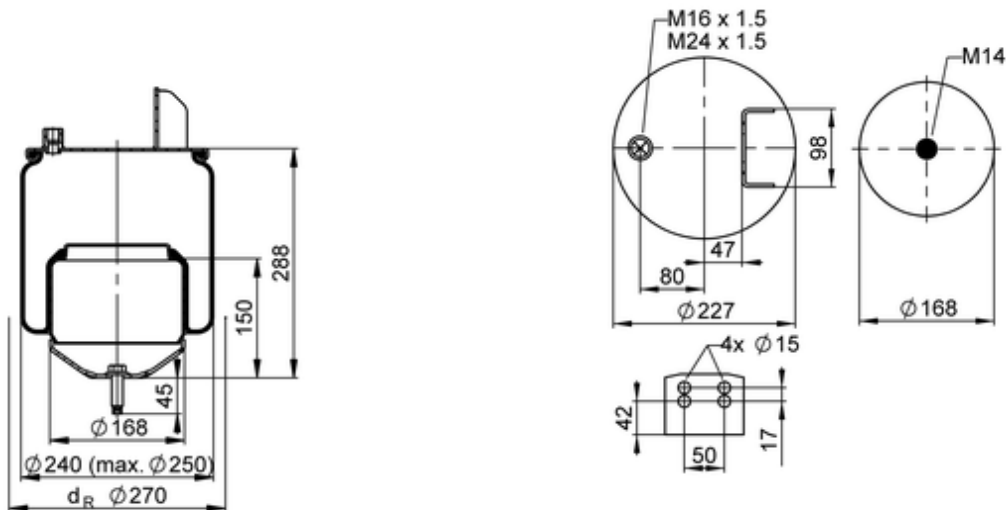







1 DF 17 A-1

72154



● bolt or stud ○ hole ⊗ combination stud ⊗ air inlet

Article status	Normal
GTIN/EAN	4054389113635
Bellow number	1 DF 17 A
 kg	5,9 kg
	10002697
	K005
	
	M14: max. 80 Nm
	M16x1.5: max. 20 Nm
	M24x1.5: max. 40 Nm

OE Manufacturer/Part No.

Manufacturer	Original Part No.	Model
Volvo	20 456 156	FH 12 medium
Volvo	20 531 987	FH 12 medium
Volvo	20 374 511	FH 12 medium
Volvo	3 171 695	FH medium
Volvo	1 076 418	FH medium
Volvo	20 582 214	FM / FH medium