



PHOENIX Air Springs

Produktprogramm | Product Range | Gamme de produits
Gama de productos | Производственная программа
Program produktów

Zeichenerklärung | Symbols

Légende | Explicación de los símbolos

Пояснения | Wyjaśnienie znaków

<p>OE</p> <p>OE Hersteller OE manufacturer Constructeurs première monte Fabricante OE Производитель оригинального оборудования Producent OEM</p>	<p> PHX</p> <p>Umschlüsselungsliste Cross reference Liste de conversion des références Lista de referencias cruzadas Перечень перекодировки продукции Lista krosująca</p>
<p>OE #</p> <p>OE Referenz-Nummer OE reference number Référence des constructeurs première monte Número de referencia OE Номер оригинального оборудования Numer referencyjny oryginalnej części zamiennej</p>	<p> PHX</p> <p>Luftfeder-Typ Air spring type Modèle de coussin d'air Tipo de fuelle neumático Тип пневматической пружины Typ resoru pneumatycznego</p>
<p> Bus Bus Bus Autobús Автобус Autobus</p>	<p> No.</p> <p>Artikelnummer Article number Numéro d'article Número de artículo Номер изделия Nr artykułu</p>
<p> Zugmaschine Towing vehicle Véhicule tracteur Tractor Тягач Ciągnik</p>	<p> Ersetzt Replaces Remplace Reemplazado Заменено Zastępuje</p>
<p> Fahrerkabine Driver's cab Cabine du conducteur Cabina del conductor Кабина водителя Kabina kierowcy</p>	<p> Seitenzahl Page number Numéro de page Número de página Нумерация страниц Numer strony</p>
<p> Anhänger/Auflieger Trailer/Semitrailer Remorque / Semi-remorque Remolque / Semiremolque Прицеп / Полуприцеп Przyczepa / Naczepa</p>	<p> Gewicht Weight Poids Peso Waga Ciężar</p>
<p> Lieferwagen/Wohnmobil Transporter/Caravans Camionnette/Camping car Furgoneta/Auto-caravana Автофургон/Кемпер Samochód kempingowy</p>	<p> Stahlkolben Steel piston Piston en acier Pistón de acero Стальной поршень Tłok stalowy</p>
<p> Oldtimer (Pkw) Vintage vehicle Voiture de collection Oldtimer Ретро-автомобиль Oldtimer</p>	<p> Kunststoffkolben Plastic piston Piston en matière plastique Pistón de plástico Пластиковый поршень Tłok z tworzywa sztucznego</p>
<p> Anwendungen Applications Applications Aplicaciones Сферы применения Stosowanie</p>	<p> Gekrempelt Pre folded Pré enroulé Rebordeado Подвёрнутая Wywinięty</p>
<p> Anmerkung Note Observation Observación Примечание Uwagi</p>	<p> Schraubensatz Screw kit Kit de vis Juego de tornillos Комплект болтов Zestaw śrub</p>
<p> Neu New Nouveau Nuevo Новинка Nowości</p>	<p> Empfohlenes Anzugsmoment Recommended torque Couple de serrage recommandé Par de apriete recomendado Рекомендуемые моменты затяжки Zalecany moment dokręcania</p>

Luftfedern | Air Springs Coussins d'air | Fuelles neumáticos Пневморессоры | Resory pneumatyczne

Die starke Marke im Ersatzmarkt

Mit über 60 Jahren Erfahrung als OE-Lieferant oder im Ersatzgeschäft für Luftfedersysteme hat sich die Marke PHOENIX als starke Marke etabliert. Das breite Produktangebot und eine konsequente Ausweitung des Produktprogramms bietet Ihnen eine Qualitätsmarke für das Ersatzgeschäft, auf die Sie sich verlassen können.

La marque forte sur le marché du remplacement

La marque PHOENIX est une marque puissante établie sur le marché, grâce à ses 60 années d'expérience, comme fournisseur première monte ou sur le marché de la rechange de systèmes pneumatiques. L'offre étendue de produits existants et l'extension constante de la gamme vous proposent une marque de qualité, digne de confiance pour le marché de la rechange.

Сильная марка на рынке запчастей

Более 60 лет опыта работы в качестве поставщика запчастей для систем пневмоподвески и поставок на конвейер позволили марке PHOENIX занять надежные позиции на рынке. В своём бизнесе по торговле запчастями Вы всегда можете положиться на нашу высококачественную марку – благодаря широкому ассортименту продукции и последовательному расширению производственной программы.

The strong brand in the replacement market

The PHOENIX brand has established itself as a strong brand in the air spring replacement market having more than 60 years experience in supplying OE manufactures or the aftermarket. With its wide range of products and continual expansion of its product range PHOENIX offers you a quality brand that you can rely on.

La marca fuerte en el mercado de recambios

La marca PHOENIX se ha establecido como marca fuerte con más de 60 años de experiencia como proveedor OE y además con representación en el mercado de recambios para sistemas de suspensión neumática. La extensa gama de productos y su constante ampliación ofrecen una marca de calidad para el mercado de recambios en la que Vd. puede confiar.

Silna marka na rynku części zamiennych































Ponad 60 letnie doświadczenie w dostarczaniu oryginalnych miechów zawieszenia na rynek części zamiennych, a także kompetencje zdobyte jako dostawca na pierwszy montaż OE, zapewniają naszej marce PHOENIX uznanie wśród klientów i miano silnej marki. Oferta produktów na rynku części zamiennych jest nieustannie poszerzana. PHOENIX oferuje produkty najwyższej jakości, na których można polegać.





























Inhaltsverzeichnis | Contents
Sommaire | Índice
Содержание | Spis treści



















































1	Zeichenerklärung Symbols Vue d'ensemble du produit Descripción del producto Краткая информация о продукте Opis produktu
4	Produktübersicht Product Overview Vue d'ensemble du produit Descripción del producto Краткая информация о продукте Opis produktu
10	Bewährte Technologie Proven Technology Technologie prouvée Tecnología probada Испытанная технология Wypróbowana technologia
12	Schraubenkits ScrewKits Kits de vis Kits de tornillos Наборы винтов Zestawy śrub
16	Produkte Products Produits Productos Продукция Produkty
112	Zuordnungslisten Fitment guide Listes de classification Lista de aplicaciones Таблицы применяемости Listy przyporządkowania
152	Umschlüsselungsliste Cross reference Liste de conversion des références Lista de referencias cruzadas Перечень перекодировки продукции Lista krosująca



















































Produktübersicht | Product Overview
 Vue d'ensemble du produit | Descripción del producto
 Краткая информация о продукте | Opis produktu

PHX	No.	2	3	 
1 A 04 Z	71536	17		
1 A 05 Z	71537	17		
1 A 06 Z	71538	17		
1 D 23 C-1	71441	18		
1 D 23 E-2	71386	18		
1 D 23 E-3	71373	18		
1 D 23 G-1	71554	19	 	
1 D 28 A-10	71563	19		
1 D 28 A-10 NP	71621	19		
1 D 28 A-12	71307	20		
1 D 28 A-13	71759	20		
1 D 28 A-2	71350	20	 	
1 D 28 A-5 NP	71364	21		
1 D 28 B-10	71553	21		
1 D 28 B-10 NP	71623	21		
1 D 28 B-11	72636	22		
1 D 28 B-12	71747	22		
1 D 28 B-2	71351	22	  	
1 D 28 B-4	71291	23		
1 D 28 B-5 NP	71352	23		
1 D 28 B-9	71346	23		
1 D 28 C-12	71347	24		
1 D 28 D-10	71588	24		
1 D 28 D-11	78143	24		
1 D 28 D-2	71587	25		











































































































PHX	No.	2	3	 
1 D 28 E-2	75057	25		
1 D 28 F-1	71304	26		
1 D 28 F-5	71744	26		
1 D 28 G-26	71265	26		
1 D 28 H-13	71552	27		
1 D 28 H-16	71331	27		
1 D 28 H-16 NP	71332	27		
1 D 28 H-17	76824	28		
1 D 28 H-17 NP	76825	28		
1 DF 16 A-1	601058	28		
1 DF 16 A-2	601059	29		
1 DF 16-2	73431	29		
1 DF 16-2 NP	73432	29		
1 DF 17 A-1	72154	30		
1 DF 17 A-2	600783	30		
1 DF 17 B-1	72155	30		
1 DF 17 B-2	74996	31		
1 DF 17 B-3	77387	31		
1 DF 17 B-4	600782	31		
1 DF 17 C-1	600938	32		
1 DF 17-1	72153	32		
1 DF 19 B-1	73434	32		
1 DF 19 B-1 NP	73435	33		
1 DF 20 A-1	72062	33		
1 DF 20 A-10	74030	33		





























PHX	No.	2	3	
1 DF 20 A-3	72064	34		
1 DF 20 A-4	72065	34		
1 DF 20 A-5	72483	35		
1 DF 20 A-6	72484	35		
1 DF 20 A-7	72485	35		
1 DF 20 A-8	72486	36		
1 DF 20 A-9	74019	36		
1 DF 20 C-1	72066	36		
1 DF 20 C-2	72487	37		
1 DF 20 C-4	76822	37		
1 DF 20 D-1	72179	37		
1 DF 20 D-2	600811	38		
1 DF 20 E-1	72180	38		
1 DF 20 E-2	77385	38		
1 DF 20 F-1	600812	39		
1 DF 20 G-1	78692	39		
1 DF 20 G-1 NP	78693	39		
1 DF 20 G-2	78694	40		
1 DF 20 G-2 NP	78695	40		
1 DF 20 G-3	78696	40		
1 DF 20 G-3 NP	78697	41		
1 DF 20 G-4	78698	41		
1 DF 20 G-4 NP	78699	41		
1 DF 22 C-1	71755	42		
1 DF 22 C-1 NP	77386	42		































PHX	No.	2	3	
1 DF 23 A-2	72488	43		
1 DF 23 A-3	72489	43		
1 DF 23 A-4	77383	43		
1 DF 23 B-1	72068	44		
1 DF 23 B-2	72069	44		
1 DF 23 B-3	72343	44		
1 DF 23 B-4	72490	45		
1 DF 23 B-5	72491	45		
1 DF 23 C-1	72341	45		
1 DF 23 C-2	78323	46		
1 DF 23 D-1	72342	46		
1 DF 23 G-1	74995	46		
1 DF 25 A-1	71322	47		
1 DF 25 A-1 NP	72173	47		
1 DF 25 A-11	71810	47		
1 DF 25 A-12	72459	48		
1 DF 25 A-2	71338	48		
1 DF 25 A-20	73436	48		
1 DF 25 A-21	73437	49		
1 DF 25 A-22	73438	49		
1 DF 25 A-30	55075	49		
1 DF 25 A-31	55076	50		
1 DF 25 A-7	72458	50		
1 DF 25 B-1 NP	72270	50		
1 DF 25 C-1	76823	51		

Produktübersicht | Product Overview
 Vue d'ensemble du produit | Descripción del producto
 Краткая информация о продукте | Opis produktu







































PHX	No.	2	3	 	PHX	No.	2	3	 
1 DF 25-1 NP	71310	51	 	 	1 DK 21 K-1	71931	60		
1 DF 25-11	71313	52			1 DK 21 K-2	72327	60		
1 DF 25-13	71314	52			1 DK 21 K-3	71726	61		
1 DF 25-14	71315	52			1 DK 21 K-32	77750	61		
1 DF 25-15	71323	53			1 DK 21 K-4	74299	61		
1 DF 25-3 NP	71311	53			1 DK 21-1	71930	62		
1 DF 32-1	77384	53			1 DK 21-2	72326	62		
1 DK 18 A-1	74785	54			1 DK 21-4	74298	62		
1 DK 19-1	73014	54			1 DK 22 D-1	72603	63		
1 DK 20 A-1	71306	54			1 DK 22 D-2	78141	63		
1 DK 20 A-51	71528	55			1 DK 22 E-11	71908	63		
1 DK 20 B-1	71308	55			1 DK 22 E-13	72637	64		
1 DK 20 B-1 NP	71683	55			1 DK 22 E-14	72638	64		
1 DK 20 C-2	71522	56			1 DK 22 E-15	75056	64		
1 DK 20 C-5	71648	56			1 DK 22 E-16	78066	65		
1 DK 21	71722	56			1 DK 22 E-17	78140	65		
1 DK 21 A-3	71658	57			1 DK 22 E-5	71431	65		
1 DK 21 A-31	71661	57			1 DK 22 E-8	71539	66		
1 DK 21 A-4	71659	57			1 DK 22 E-9	71540	66		
1 DK 21 A-4 NP	77752	58			1 DK 22 E-9 NP	71564	66		
1 DK 21 A-9	71660	58			1 DK 23 F-1	71584	67		
1 DK 21 B-4	71369	58			1 DK 23 H-0742	71317	67		
1 DK 21 B-5 NP	71377	59			1 DK 23 K-1	72071	67		
1 DK 21 C-4	78137	59			1 DK 23 K-1 NP	77751	68		
1 DK 21 C-5	600810	59			1 DK 23 K-28	72695	68		



































PHX	No.	2	3	
1 DK 23 L-1	71994	69		
1 DK 23 L-1 NP	77490	69		
1 DK 23 L-2	78691	69		
1 DK 23 L-25	71281	70		
1 DK 23 L-27	71321	70		
1 DK 23 L-31	73015	70		
1 DK 23 L-9131	71255	71		
1 DK 25-1	72192	71		
1 DK 28 B-7	71357	71		
1 DK 28 D-3	71996	72		
1 DK 28 F-3	71775	72		
1 DK 28 F-4	71693	72		
1 DK 28 F-5	72457	73		
1 DK 28 F-6	74901	73		
1 DK 28 H-3	78324	73		
1 DK 32	71723	74		
1 DK 32 E-4	71348	74		
1 DK 32 K	71724	74		
1 DK 32 K-1	71933	75		
1 DK 32 K-2	72329	75		
1 DK 32 L	71727	75		
1 DK 32 L-1	72792	76		
1 DK 32-1	71932	76		
1 DK 32-2	72328	76		
1 E 10 C	70581	77		





























PHX	No.	2	3	
1 E 16	71283	77		
1 E 16-1	71250	78		
1 E 18	71284	78		
1 E 18 C	74417	78		
1 E 18 D	72141	79		
1 E 18 D-01	72142	79		
1 E 18 D-02	72143	79		
1 E 18 D-03	76229	80		
1 E 18 E	72339	80		
1 E 21	72100	80		
1 E 21 B	72340	81		
1 E 21 C	71428	81		
1 E 21 D	71518	81		
1 E 21 E	71290	82		
1 E 21 F	74418	82		
1 E 21-6	71421	82		
1 E 23	71381	83		
1 E 23 A	72499	83		
1 E 23 A-1	72501	83		
1 E 23 B	72500	84		
1 E 23 B-1	72502	84		
1 E 25	72101	84		
1 E 25 A	72466	85		
1 E 25 B	77388	85		
1 E 25-5	75338	85		

Produktübersicht | Product Overview
 Vue d'ensemble du produit | Descripción del producto
 Краткая информация о продукте | Opis produktu

PHX	No.	2	3	 
1 E 26	71277	86		
1 E 26 A	71260	86		
1 E 26 A-01	71318	87		
1 E 26 A-13	71997	87		
1 E 26 A-14	75340	87		
1 E 26-1	71249	88		
1 E 26-3	72697	88		
1 E 32	71356	88	  	
1 F 16	71422	89	 	
1 F 20 A	71430	89	 	
1 F 20 B	71365	89		
1 F 20 C	72791	90		
1 F 20 C-1	600756	90		
1 F 20 C-2	600757	90		
1 F 20 C-3	600758	91		
1 F 20 C-4	600759	91		
1 F 21	71355	91	  	
1 F 21 A	71376	92	 	
1 F 21 C-2	71380	92	 	
1 F 21 C-5	71379	92	 	
1 F 21 D	71768	93		
1 F 26	71423	93	 	
1 F 26 B-1	71425	93	 	
1 F 26 C	71426	94		
1 F 26 D	71424	94		

PHX	No.	2	3	 
1 F 32 B	71429	95	  	
1 KF 21-1	71531	95		
1 KF 21-1 NP	71533	95		
1 KF 21-2	71532	96		
1 KF 21-2 NP	71534	96		
1 KF 21-21	71998	96		
1 KF 21-22	71999	97		
1 KF 24-1	72578	97		
1 KF 24-1 NP	72614	97		
1 KF 24-2 NP	72615	98		
1 KF 24-21	72616	98		
1 KF 24-29	72617	98		
1 KF 24-9	72577	99		
1 KF 32-23	73175	99		
1 KF 32-23 NP	73173	99		
2 B 07 R	71455	100		
2 B 12 R	71258	100		
2 B 20 R	71288	100	  	
2 B 20 R-9	71450	101		
2 B 34 R	71456	101		
2 B 34 R-B	71457	101		
2 B 49 R-A	71285	102		
2 B 49 R-B	71286	102	 	
2 C 91-10	69426	102		
2 E 18 A	71268	103		



PHX	No.			
	2	3		
2 E 23	71269	103		
2 E 23 A	71319	104		
2 F 18	71771	104		
2 F 18-1	71783	104		
2 G 20	71274	105		
2 G 20 A	71275	105		
C 075 185	72006	105		
C 100 004	71367	106		
SP 1 B 04	71296	106		
SP 1 B 07	71320	106		
SP 1 B 12-1	71262	107		
SP 1 B 34	63727	107		
SP 2 B 07 R	71389	107		
SP 2 B 12 R	71256	108		
SP 2 B 12 R-1	71263	108		
SP 2 B 12 R-16	75061	108		
SP 2 B 12 R-17	77371	109		
SP 2 B 12 R-5	71526	109		
SP 2 B 12 R-A-10	71808	109		
SP 2 B 12 R-A-3	71769	110		
SP 2 B 12 R-A-4	71883	110		
SP 2 B 12 R-B-1	601031	110		
SP 2 B 22 R-1	71885	111		
SP 2 B 34 R	71535	111		
SP 2 B 34 R-B	71473	111		



Bewährte Technologie | Proven Technology
Technologie prouvée | Tecnología probada
Испытанная технология | Wypróbowana technologia

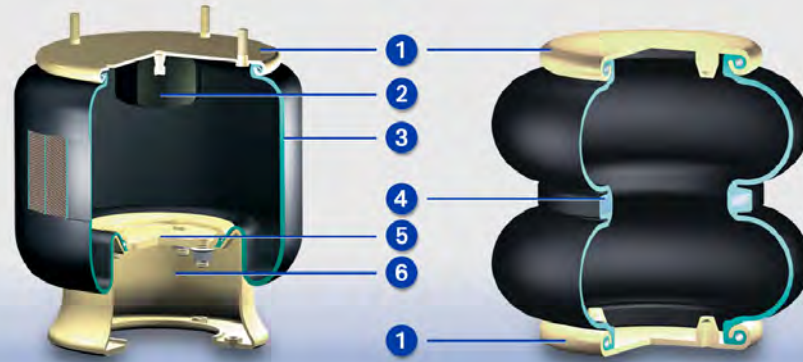

Die Komponenten im Einzelnen

- 1 Die Bördelplatte dient zur Befestigung der Luftfeder am Fahrzeugrahmen.
- 2 Der Puffer dient der Einfederbegrenzung und stellt Notlauf Eigenschaften sicher.
- 3 Das eigentliche Federelement, der Luftfederbalg, besteht aus einer Innenschicht, den Festigkeitsträgern und der äußeren Decklage.
- 4 Der Mittelring dient der Luftfederstabilisierung.
- 5 Der Klemmteller stellt das Verbindungsglied zwischen Luftfeder und Kolben dar. Je nach Artikel kann er einvulkanisiert oder als echtes Spannelement ausgeführt sein.
- 6 Der Kolben stellt die Verbindung zwischen Luftfeder und Achse dar.

Individual components

- 1 The crimping plate is used for attaching the air spring onto the vehicle frame.
- 2 The bumper is used for limiting the compression travel and provides limp-home capabilities.
- 3 The air spring bellows, which is the actual spring element, consists of an inner layer, the reinforcement and the outer covering layer.
- 4 The middle ring stabilizes the air spring.
- 5 The clamping plate is the connecting element between the air spring and piston. Depending on the article, it can be vulcanized in or configured as a true clamping element.
- 6 The piston is the connection between the air spring and the axle.

Présentation détaillée des composants

- 1 La plaque de sertissage est destinée à la fixation du coussin d'air au châssis du véhicule.
- 2 L'amortisseur sert à la limitation du débattement du ressort et se porte garant de propriétés de fonctionnement exceptionnel en cas d'urgence.
- 3 L'élément clé „ressort“, c'est à dire le coussin d'air est composé d'une couche intérieure, de supports de résistance et d'une couche enveloppante extérieure.
- 4 L'anneau médian sert à la stabilisation du coussin d'air.
- 5 Le plateau de serrage sert d'organe d'assemblage entre le coussin d'air et le piston. Il peut s'agir d'un organe vulcanisé ou être utilisé comme véritable élément de serrage.
- 6 Le piston assure la liaison entre le coussin d'air et l'essieu.



Warnung | Warning | Avertissement

Die Luftfeder darf nur im eingebauten Zustand unter Druck gesetzt werden. Betrieb nur im Federsystem des Fahrzeugs oder einer geeigneten Vorrichtung. Nicht über 7 bar beaufschlagen. Verletzungsgefahr!

The air spring may only be pressurized in fitted state. Operation only in the vehicle's air suspension system or in a suitable device. Do not apply more than 7 bar in pressure. Risk of injury!

Ne jamais mettre un coussin d'air sous pression s'il n'est pas monté. Utiliser uniquement dans le système d'amortissement du véhicule ou dans un dispositif approprié. Ne jamais pressuriser plus de 7 bars. Risque de blessures !

Lagerung | Storage | Stockage

PHOENIX Luftfedern sollen in dunklen, trockenen Räumen bei normaler Raumtemperatur gelagert werden.

- › Weitere Hinweise für Lagerung, Reinigung und Wartung von Erzeugnissen aus Kautschuk und Gummi enthält ISO 2230:2002.
- › Weitere Auskünfte sind bei der ContiTech Luftfedersysteme GmbH einzuholen.

PHOENIX air springs should be stored in dark, dry rooms at normal air temperature.

- › Further instructions for the storage, cleaning and maintenance of rubber products can be found in ISO 2230:2002.
- › For more information, please contact ContiTech Luftfedersysteme GmbH.

Stocker les coussins d'air PHOENIX dans des locaux sombres et secs à température ambiante normale.

- › La norme industrielle international ISO 2230:2002 contient des informations complémentaires pour le stockage, du nettoyage et la maintenance des produits à base de caoutchouc.
- › Contactez ContiTech Luftfedersysteme GmbH pour toute demande de renseignements complémentaires.



Los componentes en detalle

- 1 La placa rebordeada sirve para fijar el fuelle neumático al chasis del vehículo.
- 2 El amortiguador sirve para limitar la contracción del fuelle y asegurar las propiedades del funcionamiento de emergencia.
- 3 El elemento de suspensión en sí, es decir el fuelle, está compuesto de una capa interior, refuerzos y una capa de cubierta exterior.
- 4 El anillo central sirve para estabilizar el fuelle neumático.
- 5 El plato de apriete es el elemento de unión entre el fuelle neumático y el pistón. Puede estar vulcanizado o montado como un verdadero elemento de sujeción.
- 6 El pistón es la conexión entre el fuelle y el eje.

Компоненты по отдельности

- 1 Фланцевая пластина служит для крепления пневморессоры к раме автомобиля.
- 2 Буфер служит для ограничения прогиба и обеспечивает способность работы в аварийном режиме.
- 3 Собственно упругий элемент – пневмо-подушка – состоит из внутреннего слоя, каркасов и наружного покрытия.
- 4 Центральное кольцо служит для стабилизации пневморессоры.
- 5 Зажимной диск представляет собой соединительное звено между пневморессорой и поршнем. В зависимости от модели он может быть завулканизирован или выполнен как полноценный крепежный элемент.
- 6 Поршень представляет собой соединительное звено между пневморессорой и мостом.

Komponenty w szczegółach

- 1 Płyta z wywiniętym obrzeżem, służąca do mocowania resoru pneumatycznego do ramy pojazdu.
- 2 Bufor służy do ograniczenia ugięcia elementu sprężystego i zabezpieczający funkcję awaryjną.
- 3 Właściwy element sprężysto- miech resoru pneumatycznego- składa się z warstwy wewnętrznej, nośników wzmocnienia i warstwy zewnętrznej.
- 4 Pierścień środkowy służy do stabilizacji resorów pneumatycznych.
- 5 Talerz zaciskowy jest elementem łączącym resor pneumatyczny z tłokiem. W zależności od artykułu może być on wykonany jako wulkanizowany lub jako prawdziwy element mocujący.
- 6 Tłok łączy resor pneumatyczny z osią.



Advertencia | Предупреждение | Ostrzeżenie

Nunca hinchar el fuelle si no está montado. Instalarlo sólo en el sistema de suspensión del vehículo o en un dispositivo adecuado. No someterlo a una presión superior a 7 bares. ¡Peligro de lesión!

Подводить давление к пневморессоре можно только, когда она уже установлена. Эксплуатация только в рессорной системе автомобиля или в подходящем для этого устройстве. Не нагружать свыше 7 бар. Опасность получения травм!

Resor pneumatyczny może być obciążany ciśnieniem tylko wtedy, jeśli jest wbudowany. Eksploatacja tylko w systemie resorowym pojazdu lub w przeznaczonym do tego celu urządzeniu. Nie obciążać ciśnieniem powyżej 7 bar. Niebezpieczeństwo zranienia!

Almacenamiento | Хранение | Składowanie

Los fuelles neumáticos PHOENIX deben almacenarse en recintos oscuros y secos a temperatura ambiente normal.

- › La norma ISO 2230:2002 contiene información adicional sobre el almacenamiento, limpieza y mantenimiento de productos de caucho y goma.
- › Para más información contacte con ContiTech Luftfedersysteme GmbH

















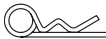







Пневморессоры PHOENIX должны храниться в тёмном сухом помещении при нормальной комнатной температуре.

- › Дополнительные указания по хранению, чистке и техобслуживанию изделий из каучука и резины содержатся в стандарте ISO 2230:2002.
- › Дополнительные справки можно навести в компании ContiTech Luftfedersysteme GmbH.

Resory pneumatyczne PHOENIX należy przechowywać w ciemnych i suchych pomieszczeniach, w normalnej temperaturze pokojowej.

- › Dalsze wskazówki dot. składowania, czyszczenia i konserwacji wyrobów z kauczuku i gumy są zawarte w ISO 2230:2002.
- › Dalsze informacje można uzyskać w ContiTech Luftfedersysteme GmbH.

Schraubenkits | ScrewKits
 Kits de vis | Kits de tornillos
 Наборы винтов | Zestawy śrub

KIT	No.		Qty.		Qty.	Others	Qty.	
K001	52726	M12 x 35	4	M12	2			 SAF
K002	52727	M12 x 35	4	M12	4			 Hendrickson, Meritor, ROR, SAF, Weweler
K003	52728	M10 x 20 M12 x 45	4 4					 Scania
K004	52729			M16	1	 Ø 3 mm	2	 Scania 4, Scania R
K005	52730	M14 x 50	2	M14	3			 Volvo
K006	52731			M10	2	 Ø 6 x 50	1	 Volvo
K007	52732			M12 M18 x 1,5	2 1			 Solaris
K008	52733	M16 x 45	1	M10	4			 VDL Bus, DAF Truck 
K009	52734	M10 x 18 M12 x 25 M12 x 190	2 2 1	M12	2			 Schmitz, Weweler
K010	52735	M12 x 170	1	M12	2			 Acerbi, Fruehauf, SMB
K011	52736	M12 x 70	2	M12	2			 Daimler TAS, ROR, Schmitz, Weweler, Holland Hitch
K013	52738			M12 M16	2 1			 SAF
K014	52739	Ejot K100 x 40	3	M12	2			 SAF
K015	52740	M12 x 35	4	M12 M20 x 1,5	2 1			 Fruehauf, SMB, Hendrickson, ROR, Weweler, SAMRO, Montenegro
K016	52741	M12 x 190	1	M12 M20 x 1,5	2 1			 Cardi, Fruehauf, SAMRO, SMB
K017	52742	M10 x 35 M12 x 35	2 4	M10	2			 Bova, Den Oudsten
K018	52743			M16 x 1,5 M24 x 1,5	1 1			 Renault, Volvo
K019	52744			M12 M20	4 1			 Kässbohrer



1 D 28 A-10	1 D 28 A-13	1 D 28 D-10
1 D 28 A-10 NP	1 D 28 B-10	1 DK 22 E-5
1 D 28 A-12	1 D 28 B-10 NP	1 DK 22 E-5 NP
1 D 28 A-2	1 D 28 B-5 NP	1 D 28 D-2
1 D 28 A-5 NP	1 D 28 B-12	1 D 28 G-26
1 D 28 B-2	1 D 28 C-12	1 D 28 H-13
1 D 28 B-9		
1 D 28 H-16	1 D 28 H-17	
1 D 28 H-16 NP	1 D 28 H-17 NP	
1 DF 17 A-1	1 DF 20 D-1	
1 DF 17 B-1	1 DF 20 E-1	
1 DF 22 C-1		
1 DF 22 C-1 NP		
1 DF 25 A-1	1 DF 25 A-2	1 DF 25 A-20
1 DF 25 A-1 NP	1 DF 25 A-7	1 DF 25 A-21
1 DF 17 B-3	1 DF 25-11	1 DF 25-13
1 DF 23 A-4	1 DF 25-12	1 DF 25-14
		1 DF 25-15
1 DK 20 A-1		
1 DK 20 B-1		
1 DK 20 B-1 NP		
1 DK 20 A-51		
1 DK 21 A-4	1 DK 28 F-3	
1 DK 21 C-4	1 DK 28 H-3	
1 DK 22 E-11	1 DK 22 E-14	
1 DK 22 E-13		
1 D 28 B-11	1 DK 22 E-8	1 DK 22 E-9 NP
1 D 28 E-2	1 DK 22 E-9	1 DK 22 E-15
1 DK 21 B-4	1 DK 23 K-28	
1 DK 23 K-1	1 DK 23 L-27	
1 DK 23 L-9131		
1 E 26-1		
1 DK 28 F-4	1 DK 28 F-6	
1 DK 28 F-5		
1 DK 32 E-4		

- › Befestigungssätze für Luftfedern der Marken ContiTech und PHOENIX
- › 100 % Passgenauigkeit
- › Exakt referenziert
- › Qualitativ hochwertige Artikel
- › Geprüft gemäß ISO Standards
- › Einheitliche Box für optimierte Logistik

- › Screw kits for ContiTech and PHOENIX air springs
- › 100 % fit
- › Clearly referenced
- › High quality content
- › Approved to ISO standards
- › Uniform packaging for optimized logistics

- › Kits de montage pour suspensions pneumatiques ContiTech et PHOENIX
- › 100 % compatibles
- › Identification simple du kit
- › Matériaux de haute qualité
- › Homologués aux normes ISO
- › Packaging standardisé pour un stockage optimisé





















- › Kits de tornillo para suspensiones neumáticas de ContiTech y PHOENIX
- › Compatibilidad 100 %
- › Claramente referenciado
- › Contenido altamente cualitativo
- › Aprobado para Estandartes ISO
- › Empaquetamiento uniformado para optimizar la logística

- › Крепежные наборы для пневморессор ContiTech и Phoenix
- › Идеальная посадка
- › Точный подбор по номеру артикула
- › Высококачественные материалы
- › Соответствие международным стандартам качества ISO
- › Унифицированная упаковка для оптимизации логистики

- › Zestawy montażowe śrub do miechów zawieszenia marki ContiTech i PHOENIX
- › 100 % kompatybilność
- › Łatwy dobór
- › Wysokiej jakości elementy montażowe
- › Zgodność z normami ISO
- › Jednolite opakowania usprawniające logistykę



Schraubenkits | ScrewKits
 Kits de vis | Kits de tornillos
 Наборы винтов | Zestawy śrub

KIT	No.		Qty.		Qty.	Others	Qty.	
K021	52746	M16 x 1,5 x 70	1	M24 x 1,5	1			 Mercedes Actros 
K022	52747			M22 x 1,5	1			 Irisbus, Iveco Bus, Heuliez
K023	52748	M10 x 60	4					 Convoluted Air Springs 1/4" M10
K024	52749					 Ø 3 mm	2	 Volvo
K025	52750	M12 x 70	2	M12 M22x 1,5	2 1			 Meritor, ROR, Weweler
K026	52751			M12 M20 x 1,5	2 1			 BPW
K027	52752	M12 x 35	4	M20	1			 Daimler TAS
K028	52753	M12 x 50	4	M12	2			 Schmitz, Weweler
K029	52754	M16 x 70	2	M12	2			 BPW (complete)
K030	52755	M12 x 70	2	M12 M20 x 1,5	2 1			 Bertoja, Fruehauf, SMB
K031	53106					 Ø 3 mm	4	 Scania 
K033	53108	M18 x 2 x 85 M18 x 2 x 130	1 1	M12 x 1,5	1			 MAN
K037	53782	M8 x 20 M12 x 50 M12 x 190	2 1 1	M12	1			 Schmitz, Weweler





1 KF 21-1 1 KF 21-1 NP 1 KF 21-2	1 KF 21-2 NP 1 KF 21-21 1 KF 21-22	1 KF 24-1 1 KF 24-1 NP 1 KF 24-2 NP	1 KF 24-9 1 KF 24-21 1 KF 24-29	1 KF 32-23 1 KF 32-23 NP	
1 E 23 A-1 1 E 23 B-1	2 F 18-1				
SP 2 B 12 R SP 2 B 12 R-5	SP 2 B 12 R-A-10				
1 DF 17-1 1 DF 25 C-1 NP					
1 DK 21 A-3 1 DK 21 A-31					
1 DK 21 K-3					
1 DK 25-1					
1 D 28 F-1 1 D 28 F-5					
1 DK 21 1 DK 21-1 1 DK 21-2	1 DK 21 K 1 DK 21 K-1 1 DK 21 K-2	1 DK 32 1 DK 32-1 1 DK 32-2	1 DK 32 K 1 DK 32 K-1 1 DK 32 K-2	1 DK 32 L 1 DK 32 L-1	
1 DK 23 L-25					
1 DF 20 A-1 1 DF 20 A-2 1 DF 20 A-3 1 DF 20 A-4	1 DF 20 A-5 1 DF 20 A-6 1 DF 20 A-7 1 DF 20 A-8	1 DF 20 A-9 1 DF 20 A-10 1 DF 20 C-1 1 DF 20 C-2	1 DF 23 A-1 1 DF 23 A-2 1 DF 23 A-3	1 DF 23 B-1 1 DF 23 B-2 1 DF 23 B-3 1 DF 23 B-4	1 DF 23 B-5 1 DF 23 C-1 1 DF 23 C-2 1 DF 23 D-1
1 DF 16-2 1 DF 19 B-1					
1 DK 23 L-1 1 DK 23 L-1 NP	1 DK 23 L-2				

- › Die Schraubenkits sind auch auf den Produktseiten der entsprechenden Luftfedertypen aufgeführt.
- › The screw kits are also listed on the product pages of the corresponding air spring types.
- › Les kits de vis figurent également sur les pages de produits correspondants aux coussins d'air.
- › Los kits de tornillos aparecen también en las páginas de productos de los tipos de fuelles neumáticos correspondientes.
- › Наборы винтов указаны также на страницах с продуктами соответствующих типов пневматических пружин.
- › Zestawy śrub podane są także na stronach produktów odpowiednich typów resorów pneumatycznych.





Produkte | Products
Produits | Productos
Продукция | Produkty

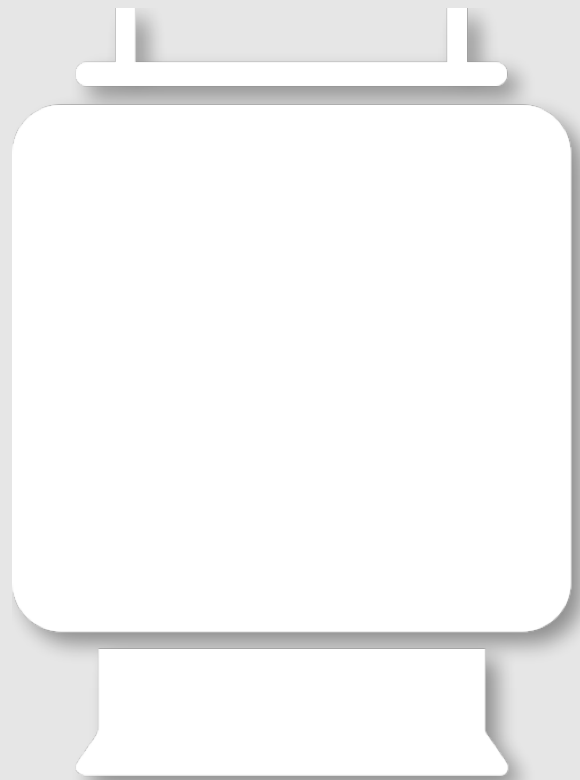

1 A 04 Z



71536



0,6 kg

Mercedes A 112 320 00 17

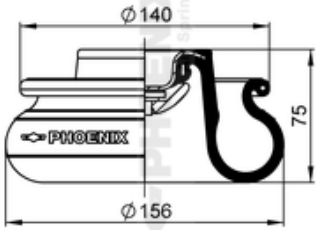

1 A 05 Z



71537

0,6 kg

Mercedes A 112 320 00 21

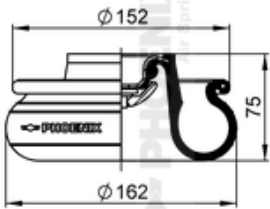

1 A 06 Z



71538

0,5 kg

Mercedes A 100 320 01 17

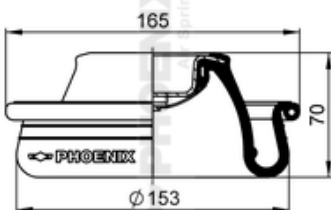

● bolt or stud ○ threaded hole ⊗ combination stud ⊗ air inlet



1 D 23 C-1



4 054389 106507

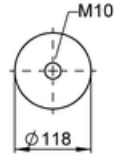
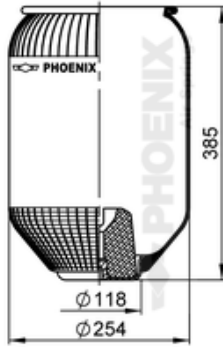

71441

kg 2,9 kg



BredaMenarini
MAN 81.43601.6029
MAN 81.43601.6023
MAN 81.43601.6030
MAN 81.43601.6002

1 D 23 E-2



4 054389 105951

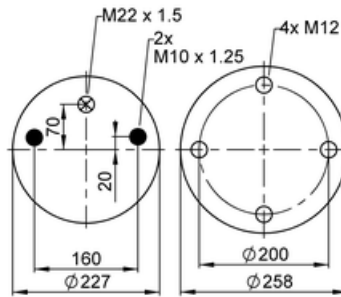
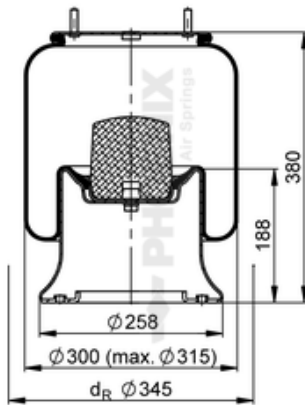

71386

kg 10,6 kg



Viberti 128147109



M10x1,25 = 35 Nm
M12 = 40 Nm
M22x1,5 = 20 Nm

1 D 23 E-3



4 054389 105821

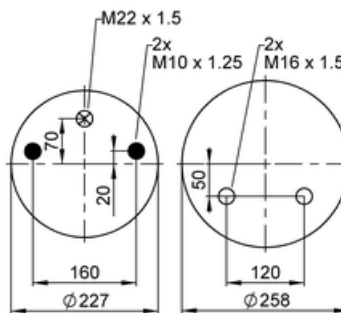
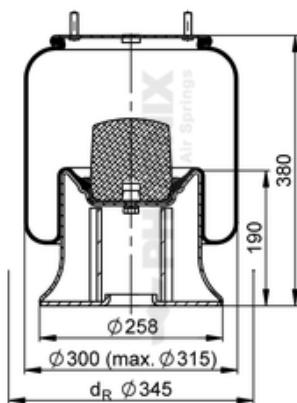

71373

kg 13,2 kg



Cardi 58050900
Omar 11808
Zorzi 1006551



M10x1,25 = 35 Nm
M16x1,5 = 80 Nm
M22x1,5 = 20 Nm

● bolt or stud ○ threaded hole ⊗ combination stud ⊗ air inlet

1 D 23 G-1



4 054389 107634

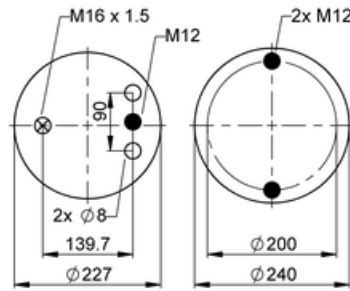
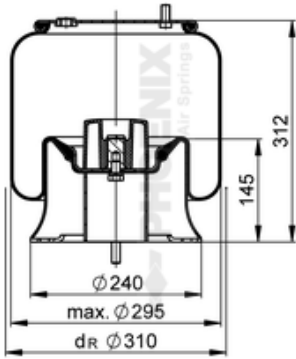

71554

kg 8,9



DAF 1 407 329
Hendrickson H 505431
Hendrickson HS505431-03

M12 = 70 Nm
M16x1,5 = 20 Nm



1 D 28 A-10



4 054389 107726

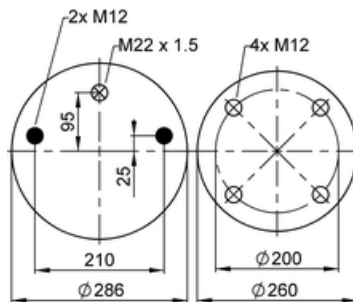
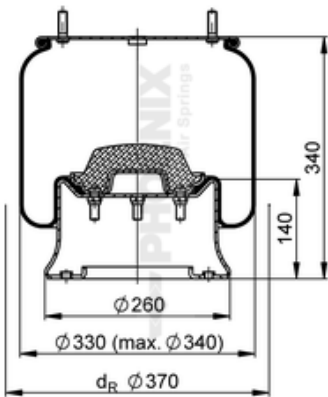

71563

kg 12,5



SAF - Holland 2918V
SAF - Holland 3.229.0027.00
SAF - Holland 3.229.2127.00
SAF - Holland 3.229.2227.00
Scania 1723275

K001

M12 = 70 Nm
M22x1,5 = 20 Nm

1 D 28 A-10 NP



4 054389 108303

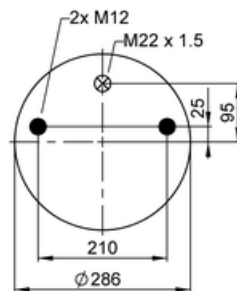
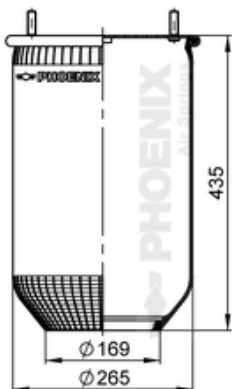

71621

kg 4,1

SA for A-10;12;13

Meritor
SAF - Holland

K001

M12 = 70 Nm
M22x1,5 = 20 Nm

● bolt or stud ○ threaded hole ⊗ combination stud ⊗ air inlet



1 D 28 A-12



4 054389 105166

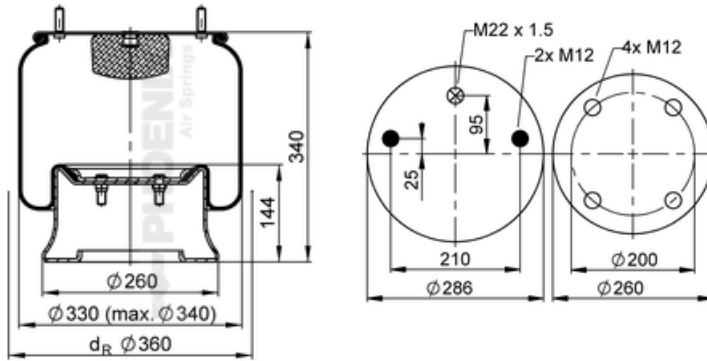

71307

12,3 kg



Weweler US 07337 ST2
Schmitz 016 010
SMB 09377007
Leciñena
Weweler US 07337CST2
Weweler US 07337GST2
Weweler US 07337FST2
Weweler YP07337ST2F
and more...

K001

M12 = 70 Nm
M22x1,5 = 20 Nm

1 D 28 A-13



4 054389 109683

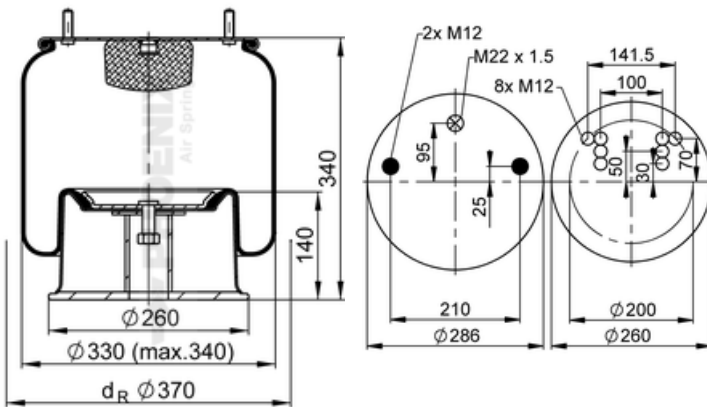

71759

13,5 kg



Daimler TAS A 946 328 19 01
Weweler US 07337R
Weweler US 07337RP
Leciñena 120025000199
Jost JAE 20 105 019 01
Jost JAS 20 105 019 01
Jost 2010501901
Daimler TAS 946 328 19 01
and more...

K001

M12 = 70 Nm
M22x1,5 = 20 Nm

1 D 28 A-2



4 054389 105593

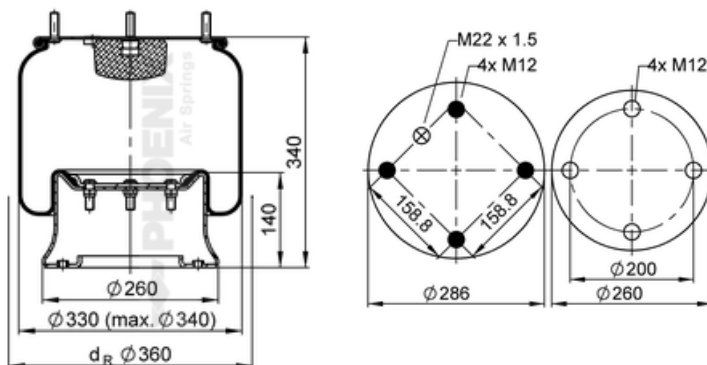

71350

12 kg



Hendrickson 506 243
Meritor 2120 8082
Meritor 2121 5632
SAF - Holland 2.228.0002.00
SAF - Holland 2.229.0002.00
Weweler 2120 8082
Weweler US 874131
Neway 21215632
and more...

K002

M12 = 70 Nm
M22x1,5 = 20 Nm

● bolt or stud ○ threaded hole ⊗ combination stud ⊗ air inlet

1 D 28 A-5 NP



4 054389 105739

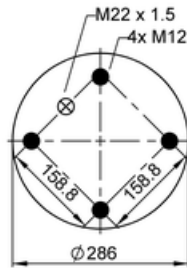
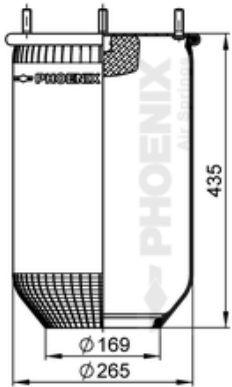

71364

kg 4,8 kg

i SA for A-2

SAF Meritor
SAF - Holland

K002

M12 = 70 Nm
M22x1,5 = 20 Nm



1 D 28 B-10



4 054389 107627

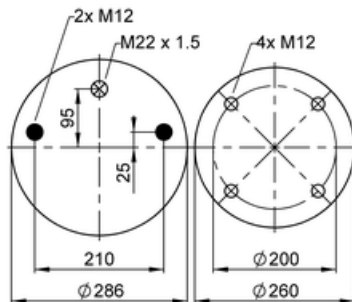
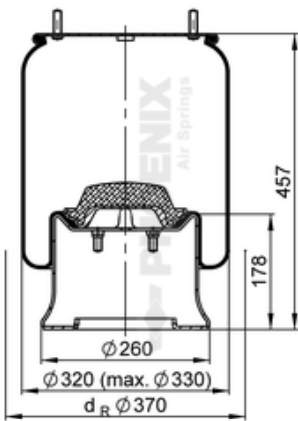

71553

kg 13,3 kg

i

SAF SAF - Holland 2923V
SAF - Holland 3.229.0031.00
SAF - Holland 3.229.2131.00
SAF - Holland 3.229.2231.00
SAF - Holland 3.229.2431.00
Schmitz 751 082
Scania 1723280

K001

M12 = 70 Nm
M22x1,5 = 20 Nm

1 D 28 B-10 NP



4 054389 108327

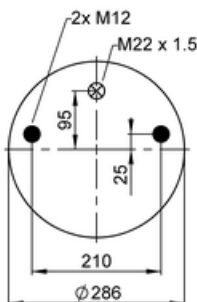
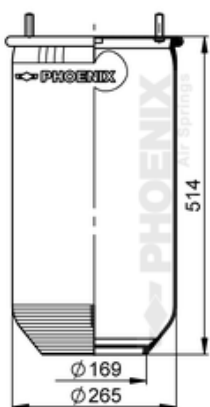

71623

kg 6,7 kg

i SA for B-10, B-11

SAF SAF - Holland

K001

M12 = 70 Nm
M22x1,5 = 20 Nm

● bolt or stud ○ threaded hole ⊗ combination stud ⊗ air inlet



1 D 28 B-11



4 054389 118456

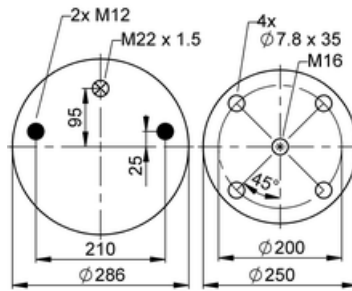
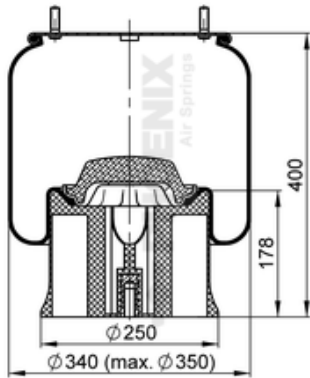

72636

kg 10,7



SAF - Holland 2923VK
SAF - Holland 3.229.0028.00
SAF - Holland 2924V
SAF - Holland 3.229.0041.00



Scania 1873863
Scania 1723276

1 D 28 B-12



4 054389 109560

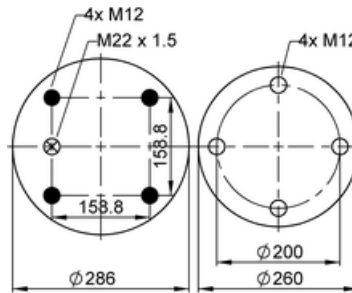
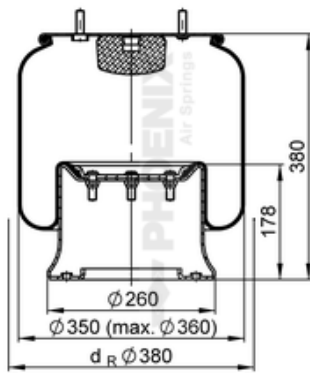

71747

kg 12,7



Meritor 2122 2239



K002



M12 = 70 Nm
M22x1,5 = 20 Nm

1 D 28 B-2



4 054389 105609

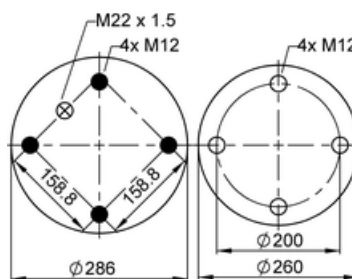
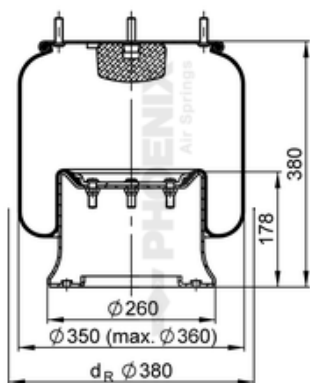

71351

kg 13,2



Hendrickson 505 859
Kässbohrer 4.731.033.000
Kässbohrer 4.731.030.000
SAF - Holland 2923
SAF - Holland 2.229.0003.00
SAF - Holland 2.229.2403.00
Weweler US 87408
Granning 15634
and more..



K002



M12 = 70 Nm
M22x1,5 = 20 Nm

● bolt or stud ○ threaded hole ⊗ combination stud ⊗ air inlet

1 D 28 B-4



4 054389 105005

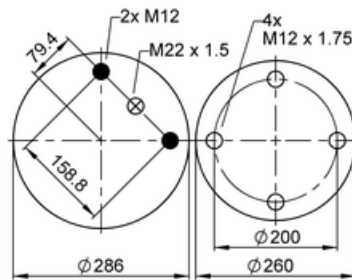
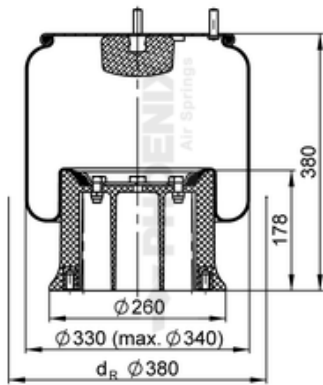

71291

kg 9,4

i

Lecitrailer SN21502

M12 = 70 Nm
M22x1,5 = 20 Nm



1 D 28 B-5 NP



4 054389 105616

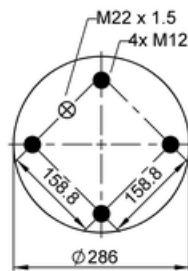
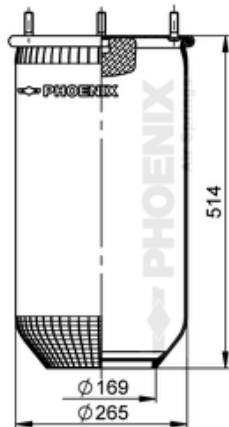

71352

kg 5,9

i service assembly for B-2,(B-4),B-12

Meritor
SAF - Holland

K002

M12 = 70 Nm
M22x1,5 = 20 Nm

1 D 28 B-9



4 054389 105555

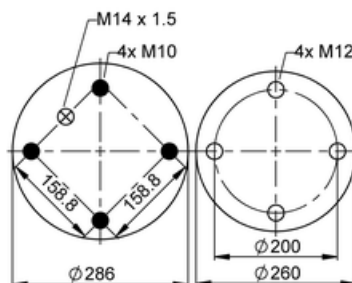
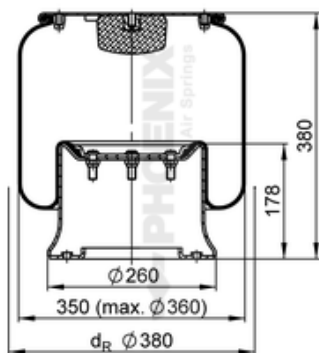

71346

kg 12,9

i

Scania 1865755
Scania 1314906
Scania 1107674
Scania 325748
Scania 298568
Scania 255293

K003

M10 = 35 Nm
M12 = 70 Nm
M14x1,5 = 20 Nm

● bolt or stud ○ threaded hole ⊗ combination stud ⊗ air inlet



1 D 28 C-12



4 054389 105562

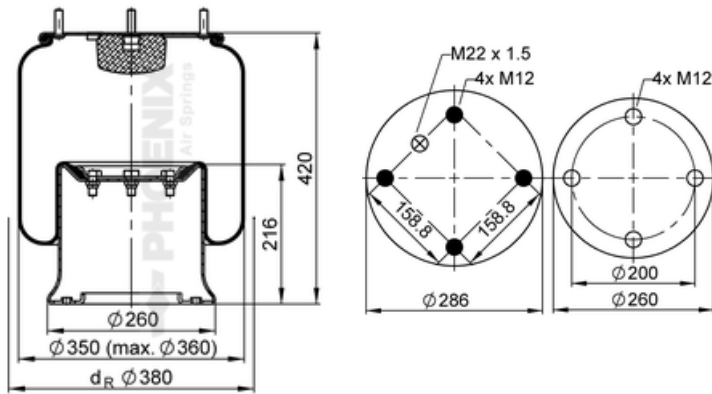

71347

13.7 kg

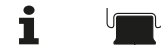

Fruehauf UJB 0305-001
Weweler US 07380
SAMRO H2500361
Meritor 2122 1349
SAF - Holland 2926
SAF - Holland 3.229.0024.00
Scania 1873856
Weweler YP07380F
and more...

K002

M12 = 70 Nm
M22x1,5 = 20 Nm

1 D 28 D-10



4 054389 107979

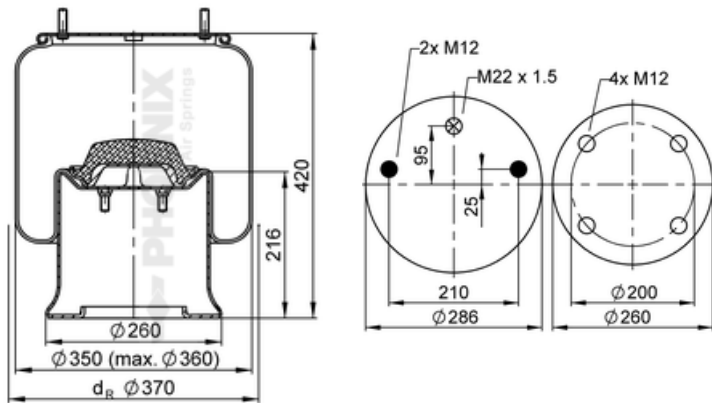

71588

14.7 kg



SAF - Holland 2926V
SAF - Holland 3.229.0030.00
Weweler US 07385

K001

M12 = 70 Nm
M22x1,5 = 20 Nm

1 D 28 D-11



4 054389 128646

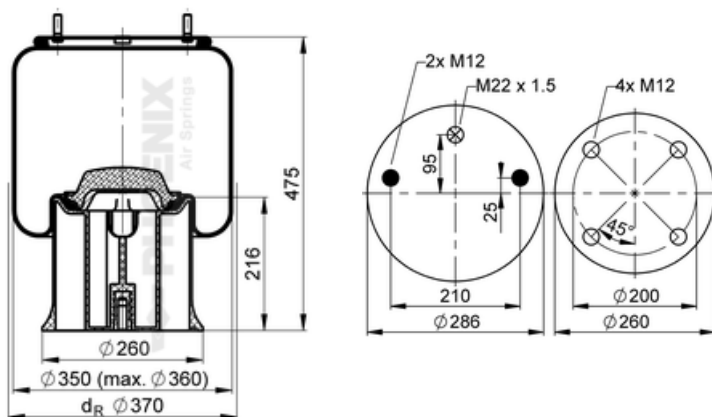

78143

11.6 kg



SAF - Holland 2927V
SAF - Holland 3.229.0047.00

● bolt or stud ○ threaded hole ⊗ combination stud ⊗ air inlet

1 D 28 D-2



4 054389 107962

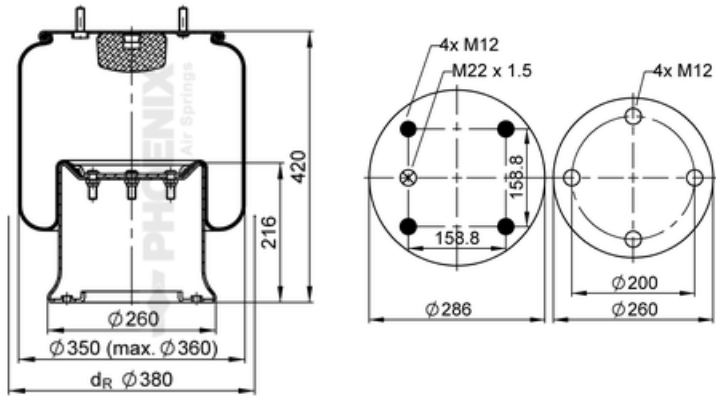

71587

kg 14,5 kg

i

Meritor 2122 2673
Weweler US 96681
Hendrickson 507 782

K002

M12 = 70 Nm
M22x1,5 = 20 Nm



1 D 28 E-1



4 054389 119255

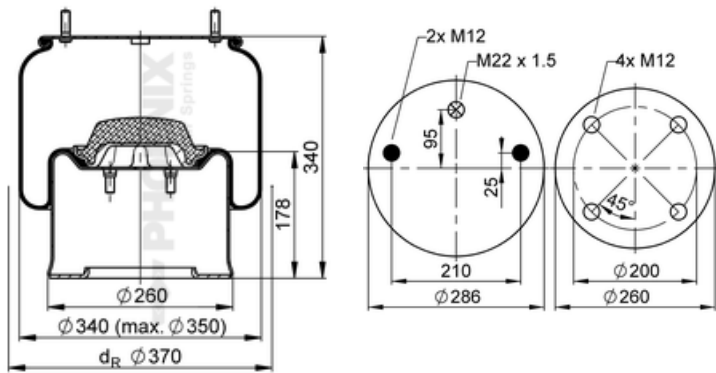

72844

kg 13,6 kg

i

SAF - Holland 2922V
SAF - Holland 3.229.0036.00

1 D 28 E-2



4 054389 124129

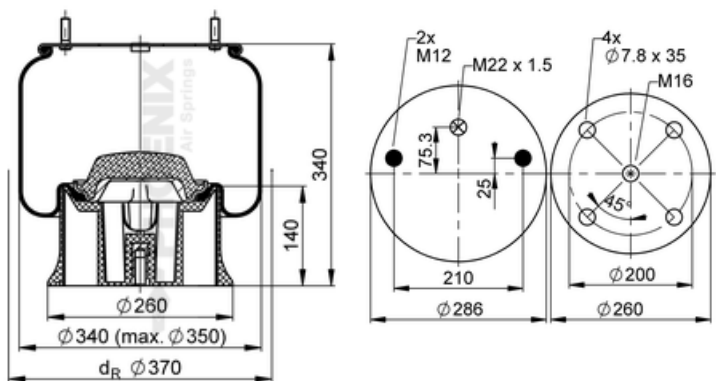

75057

kg 9,3 kg

i

SAF - Holland 2919V
SAF - Holland 3.229.0042.00

K014

● bolt or stud ○ threaded hole ⊗ combination stud ⊗ air inlet



1 D 28 F-1

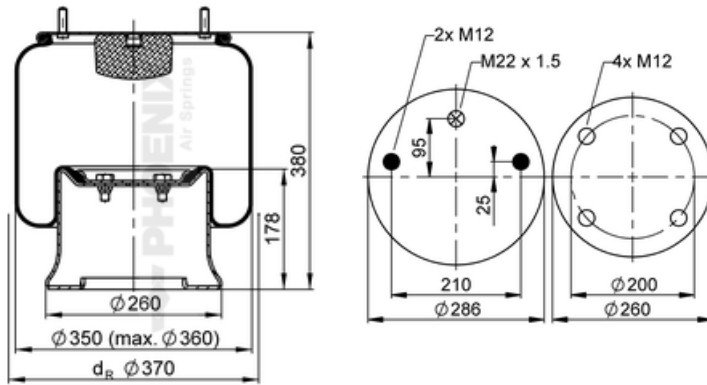

71304

- 12 kg

-

- Schmitz 015 323
SMB 09377008
Valx 80131003
Weweler US 04028

- Scania 2198335
Weweler YP4028N2-F

- K028

- M12 = 70 Nm
M22x1,5 = 20 Nm

1 D 28 F-5

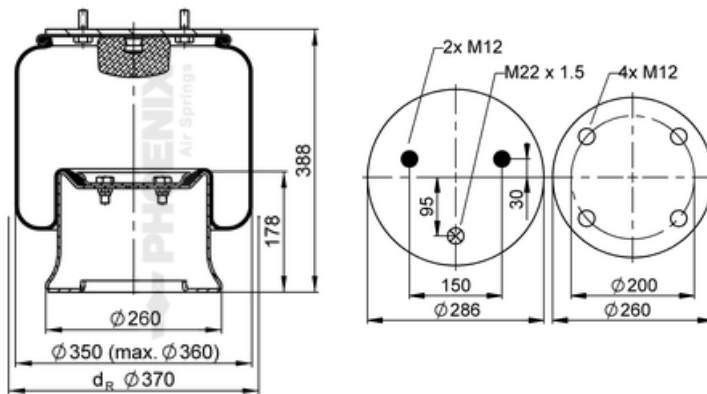

71744

- 15,8 kg

-

- Schmitz 017 089
Schmitz 017 685
Weweler US 04029P
Weweler US 04031P

- Scania 2198324
Weweler YP4031N-F

- K028

- M12 = 70 Nm
M22x1,5 = 20 Nm

1 D 28 G-26

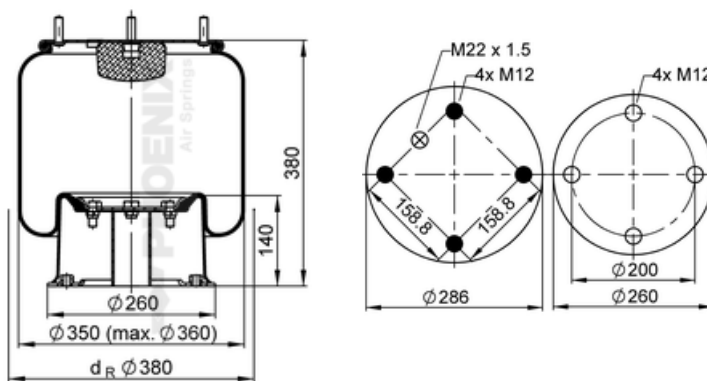

71265

- 11,2 kg

-

- Kaiser A 06030620
SAMRO H2500008
York 61.506243.01

- K002

- M12 = 70 Nm
M22x1,5 = 20 Nm

● bolt or stud ○ threaded hole ⊗ combination stud ⊗ air inlet

1 D 28 H-13



4 054389 107610

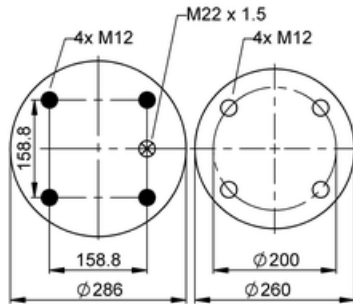
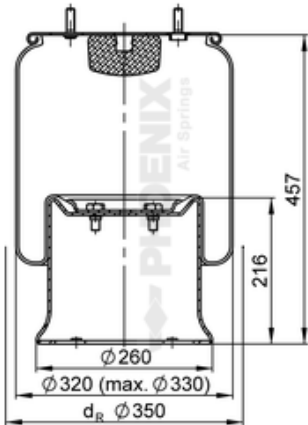

71552

kg 13,4 kg



SMB M060770

K002

M12 = 70 Nm
M22x1,5 = 80 Nm



1 D 28 H-16



4 054389 105401

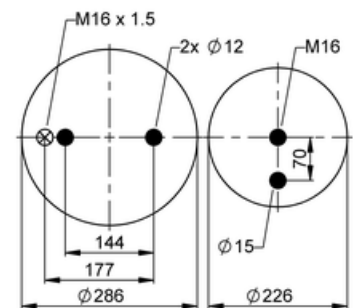
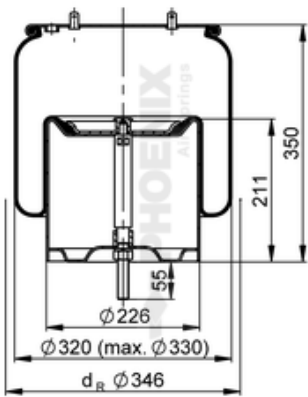

71331

kg 12,3 kg



Scania 1543691
Scania 1379392
Scania 1440294

K004

M16x1,5 = 50 Nm
M16 = 130 Nm

1 D 28 H-16 NP



4 054389 105418

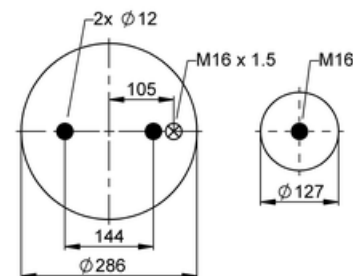
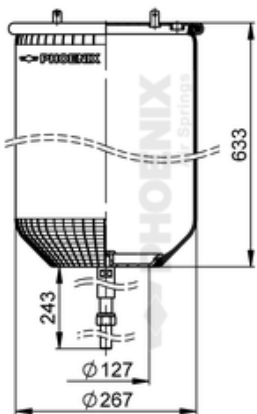

71332

kg 6,4 kg

i SA for H-16

Scania 1379393

K004

M16x1,5 = 50 Nm
M16 = 70 Nm

● bolt or stud ○ threaded hole ⊗ combination stud ⊗ air inlet



1 D 28 H-17



4 054389 126529

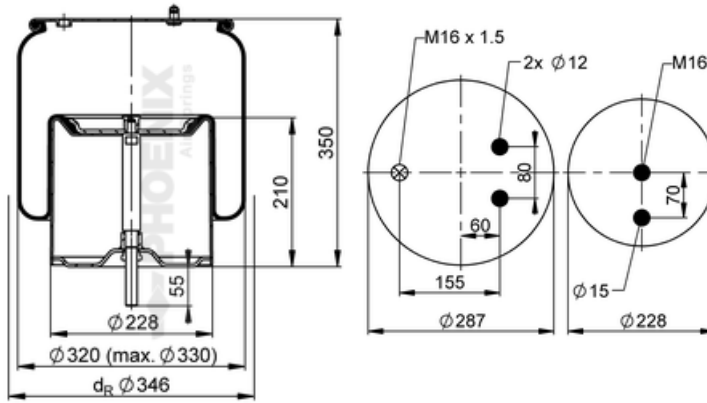

76824

kg 10,6



- Scania 1774804
- Scania 1903608
- Scania 1944314
- Scania 2198915
- Scania 2357460
- Scania 2357532
- Scania 2808412

K004

1 D 28 H-17 NP



4 054389 126536

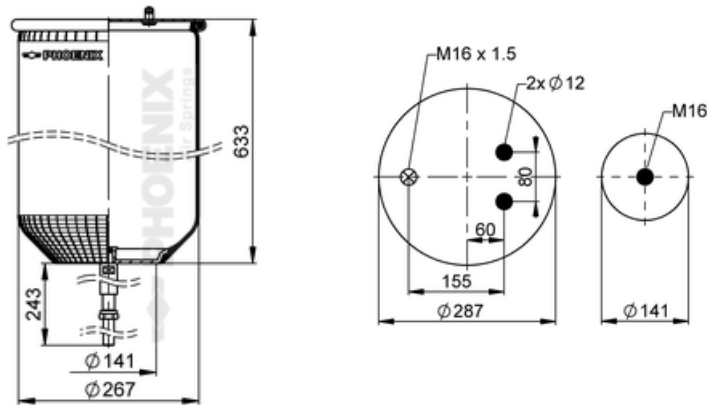

76825

kg 4,5

i service assembly for H-17

K004

1 DF 16 A-1



4 054389 134210

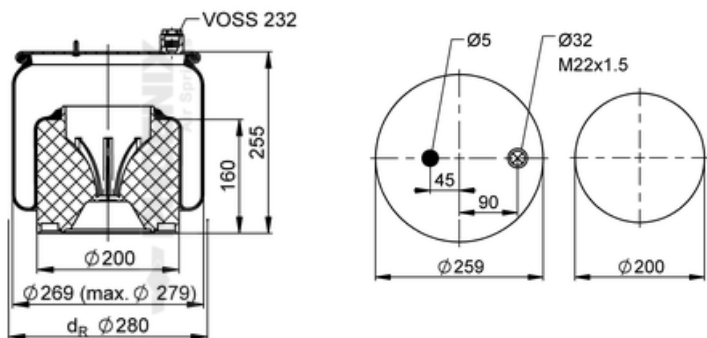

601058

kg 6,4



- Mercedes A 960 320 00 57
- Mercedes A 960 320 67 57
- Mercedes A 960 320 70 21
- Mercedes 960 320 00 57
- Mercedes 960 320 67 57
- Mercedes 960 320 70 21

● bolt or stud ○ threaded hole ⊗ combination stud ⊗ air inlet

1 DF 16 A-2



4 054389 134227

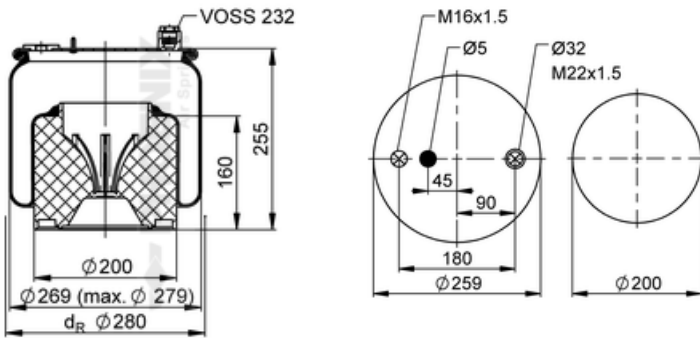

601059

kg 6,5



- Truck** Mercedes A 960 320 01 57
- Mercedes A 960 320 68 57
- Mercedes A 960 320 77 21
- Mercedes 960 320 01 57
- Mercedes 960 320 68 57
- Mercedes 960 320 77 21



1 DF 16-2



4 054389 121111

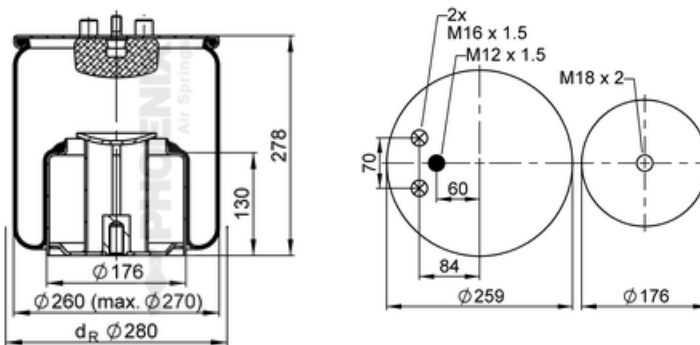

73431

kg 7,7



- Truck** MAN 81.43600.6036
- MAN 81.43600.6056
- MAN 81.43600.6079

Washer K033

1 DF 16-2 NP



4 054389 121128

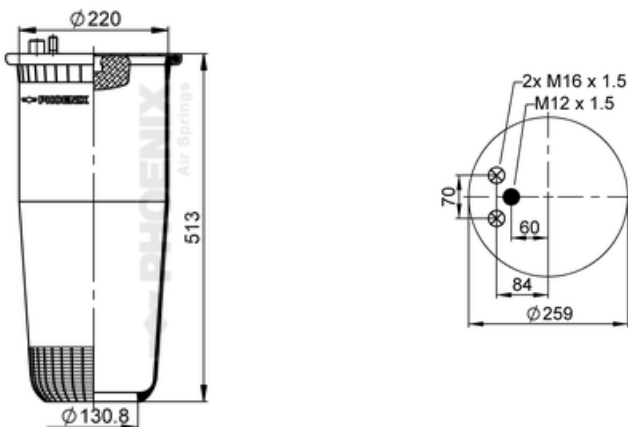

73432

kg 3,8

i service assembly

- Truck** MAN 81.43601.0151
- MAN 81.43601.0181

● bolt or stud ○ threaded hole ⊗ combination stud ⊗ air inlet



1 DF 17 A-1

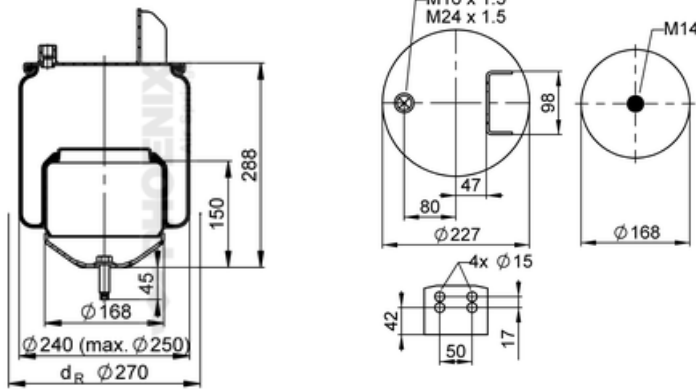

72154

kg 5,9 kg



- Volvo 20 582 214
- Volvo 20 531 987
- Volvo 20 456 156
- Volvo 20 374 511
- Volvo 3 171 695
- Volvo 1 076 418

K005

M14 = 80 Nm
M16x1,5 = 20 Nm
M24x1,5 = 40 Nm

1 DF 17 A-2

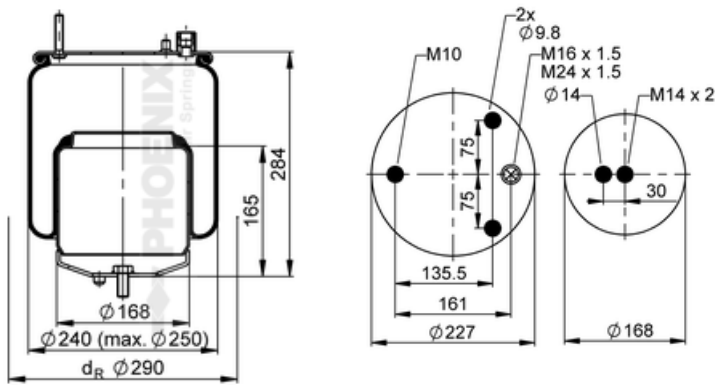

600783

kg 5,8 kg



- Volvo 22 056 630
- Volvo 21 224 750

1 DF 17 B-1

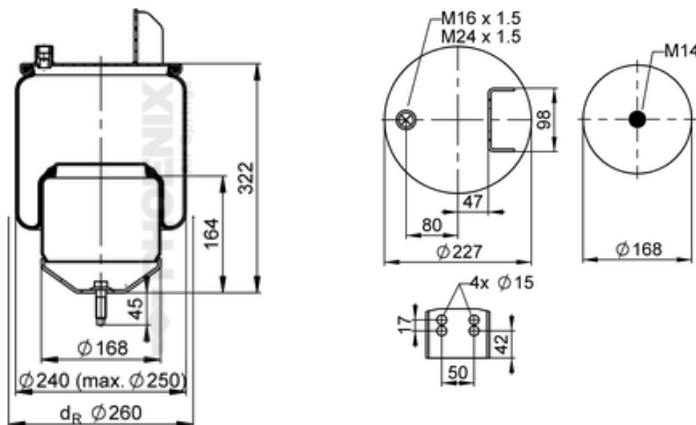

72155

kg 5,3 kg



- Volvo 21 961 456
- Volvo 20 582 215
- Volvo 20 531 985
- Volvo 20 456 152
- Volvo 20 374 510
- Volvo 1 076 416
- Volvo 1 075 891

K005

M14 = 80 Nm
M16x1,5 = 20 Nm
M24x1,5 = 40 Nm

● bolt or stud ○ threaded hole ⊗ combination stud ⊗ air inlet

1 DF 17 B-2



4 054389 123856

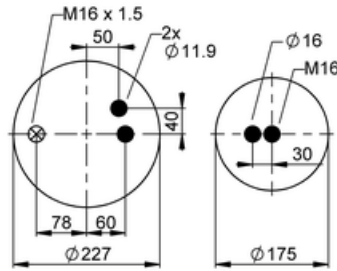
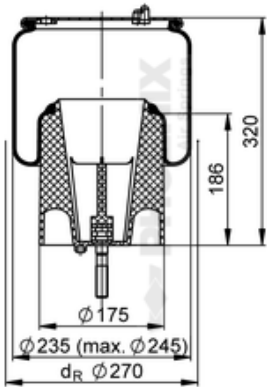

74996

kg 5,5



Scania 261 7884
Scania 1932592
Scania 1434930



1 DF 17 B-3



4 054389 127182

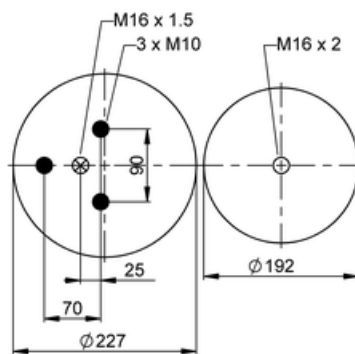
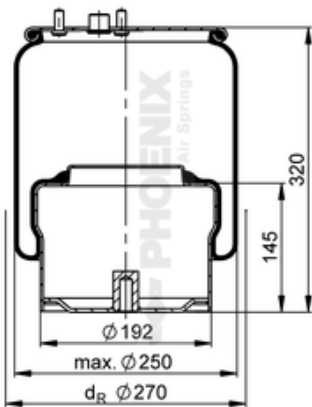

77387

kg 7,2



DAF 1 698 434
DAF 1 279 141
DAF 1 529 835

kg K008

1 DF 17 B-4



4 054389 133206

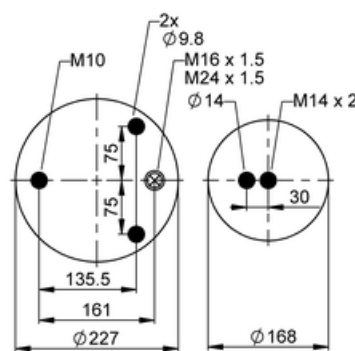
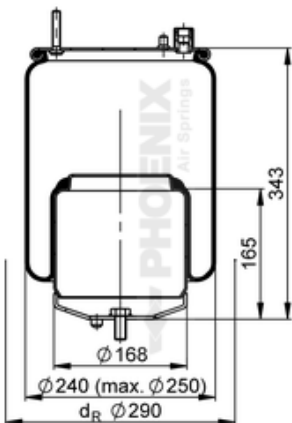

600782

kg 6,2



Volvo 22 058 741

● bolt or stud ○ threaded hole ⊗ combination stud ⊗ air inlet



1 DF 17 C-1

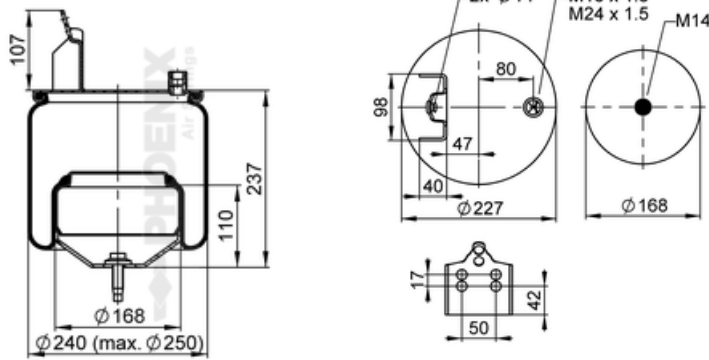

600938

kg 5,7 kg



- Volvo 21 961 448
- Volvo 20 582 213
- Volvo 20 531 989
- Volvo 20 456 160
- Volvo 20 374 512
- Volvo 1 076 420

K005

1 DF 17-1

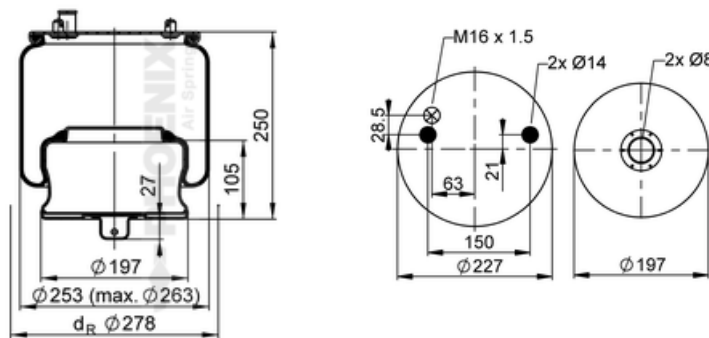

72153

kg 5,2 kg



- Volvo 20 573 108
- Volvo 70 376 919
- Volvo 70 321 692

K024

M16x1,5 = 40 Nm

1 DF 19 B-1

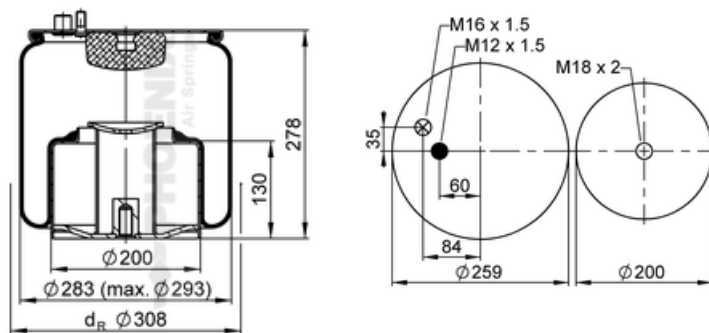

73434

kg 9,4 kg



- MAN 81.43600.6035
- MAN 81.43600.6055
- MAN 81.43600.6078

K033

● bolt or stud ○ threaded hole ⊗ combination stud ⊗ air inlet

1 DF 19 B-1 NP



4 054389 121159

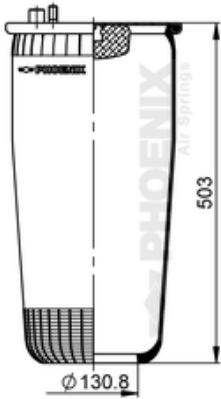

73435

kg 3,9

i service assembly

🚛 MAN 81.43601.0152
MAN 81.43601.0174
MAN 81.43601.0175
MAN 81.43601.0180



1 DF 20 A-1



4 054389 112713

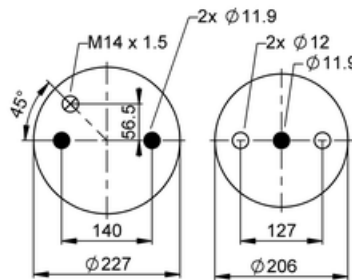
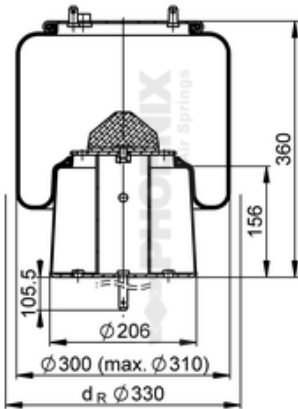

72062

kg 8,6

i

🚛 Scania 1440306

🔧 K031

🔧 M14x1,5 = 20 Nm

1 DF 20 A-10



4 054389 122446

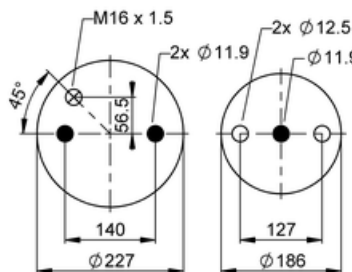
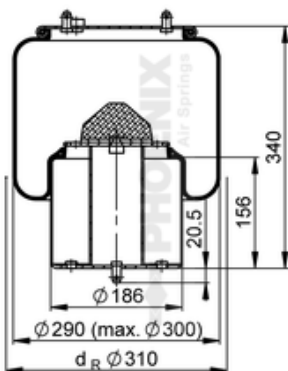

74030

kg 7,7

i

🚛 Scania 2024288

🔧 K031

● bolt or stud ○ threaded hole ⊗ combination stud ⊗ air inlet



1 DF 20 A-2



4 054389 112720

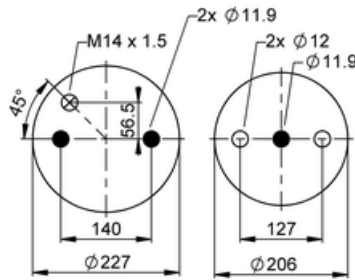
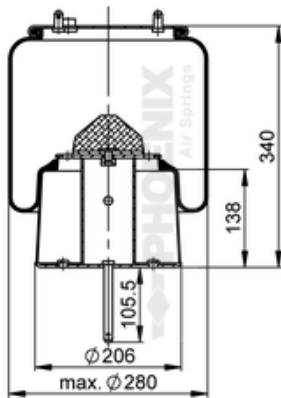

72063

8,3 kg



Scania 1440305

K031

M14x1,5 = 20 Nm

1 DF 20 A-3



4 054389 112737

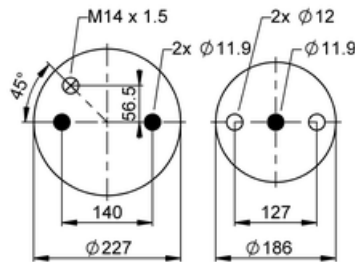
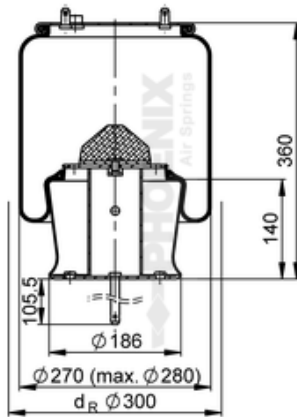

72064

8,1 kg



Scania 1440304

K031

M14x1,5 = 20 Nm

1 DF 20 A-4



4 054389 112744

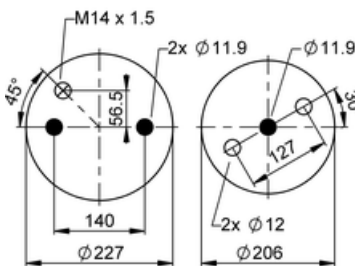
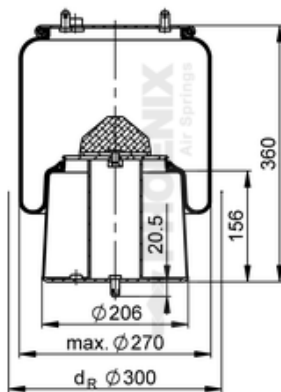

72065

8,6 kg



Scania 1434506

K031

M14x1,5 = 20 Nm

● bolt or stud ○ threaded hole ⊗ combination stud ⊗ air inlet

1 DF 20 A-5



4 054389 116926

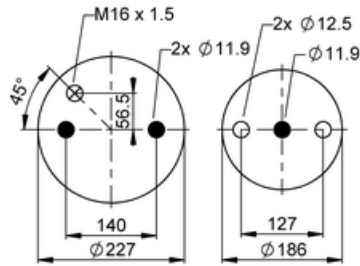
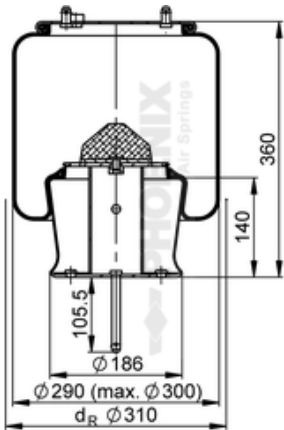

72483

kg 8,2



Scania 1726240

K031



1 DF 20 A-6



4 054389 116933

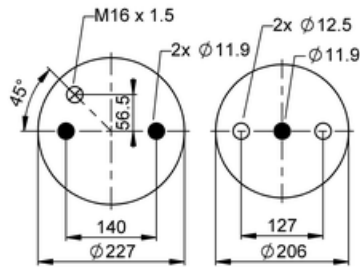
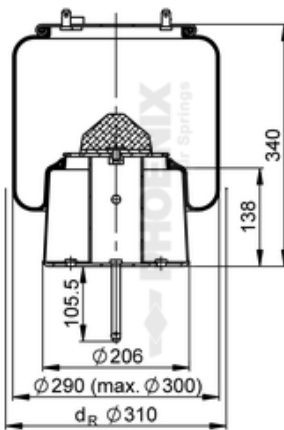

72484

kg 7,9



Scania 1726241

K031

1 DF 20 A-7



4 054389 116940

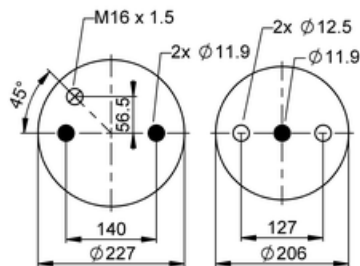
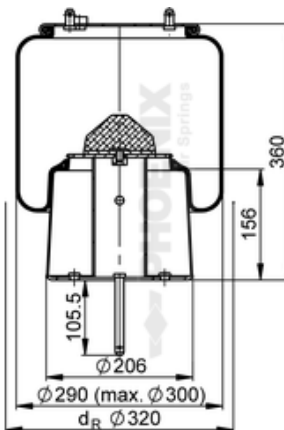

72485

kg 8,1



Scania 1726242

K031

● bolt or stud ○ threaded hole ⊗ combination stud ⊗ air inlet



1 DF 20 A-8

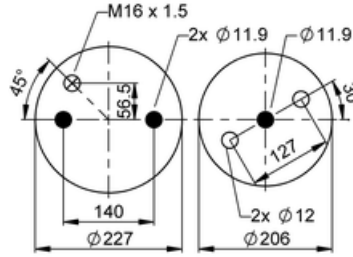
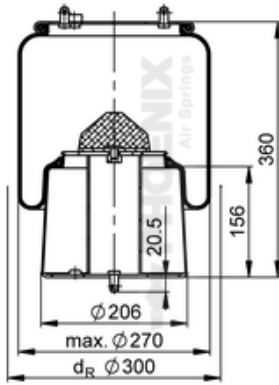

72486

8 kg



Scania 1726243

K031

1 DF 20 A-9

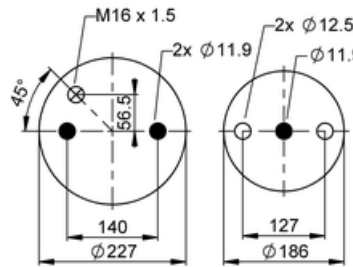
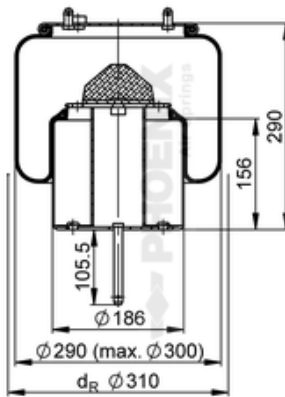

74019

7.8 kg



Scania 2024290
Scania 2024287

K031

1 DF 20 C-1

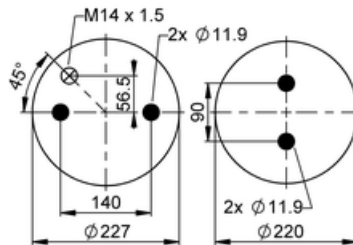
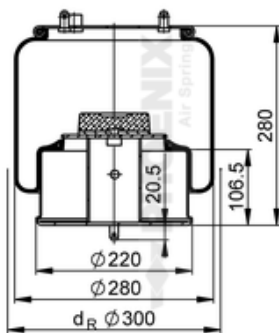

72066

7.6 kg



Scania 1521114
Scania 1440303
Scania 1475106

K031

$M14 \times 1.5 = 20 \text{ Nm}$

● bolt or stud ○ threaded hole ⊗ combination stud ⊗ air inlet

1 DF 20 C-2

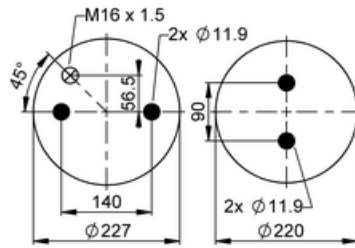
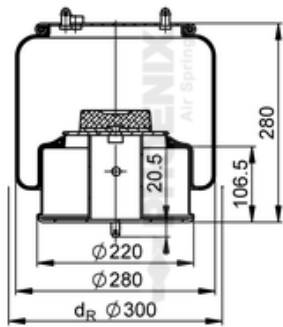

72487

kg 7.2 kg



Scania 1726257
Scania 1726239

K031



1 DF 20 C-4

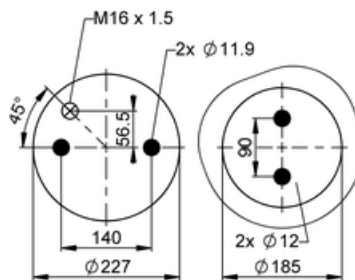
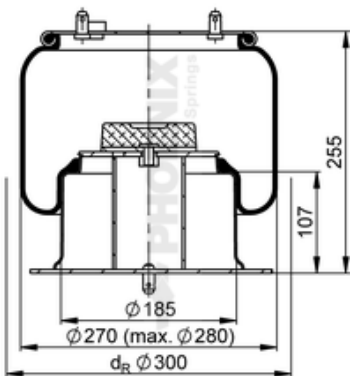

76822

kg 7.5 kg



Scania 2024285
Scania 2024284
Scania 2024283

K031

1 DF 20 D-1

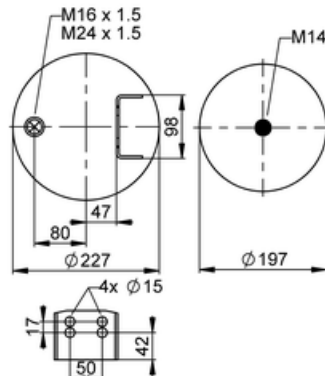
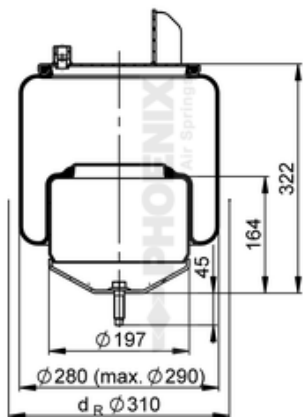

72179

kg 7 kg



Volvo 21 961 374
Volvo 20 582 206
Volvo 20 531 984
Volvo 20 456 150
Volvo 20 427 800
Volvo 20 375 226
Volvo 1 075 890
Volvo 1 076 415
and more..

K005

M14 = 80 Nm
M16x1,5 = 20 Nm
M24x1,5 = 40 Nm

● bolt or stud ○ threaded hole ⊗ combination stud ⊗ air inlet



1 DF 20 D-2

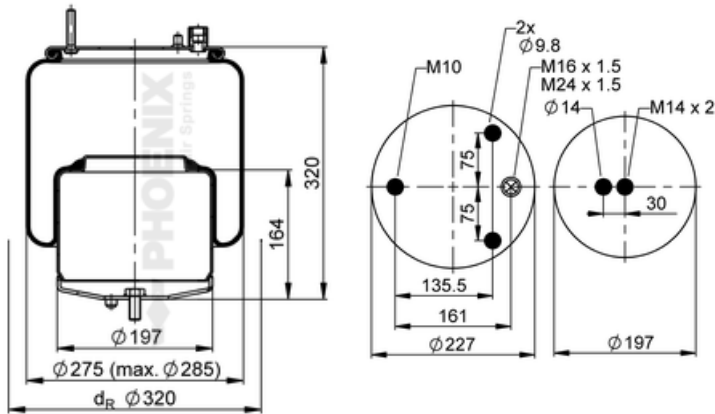

600811

kg 6,4 kg



for Volvo 22 058 737
Volvo 21 224 745

1 DF 20 E-1

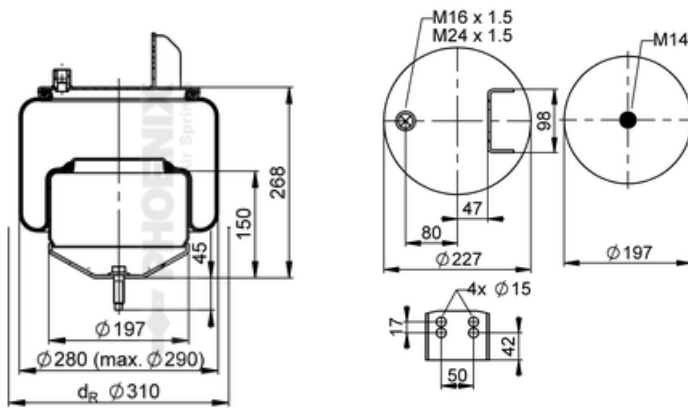

72180

kg 6,4 kg



for Volvo 20 582 209
Volvo 20 531 986
Volvo 20 456 154
Volvo 20 427 801
Volvo 20 375 227
Volvo 3 171 694
Volvo 10 764 417
Volvo 1 076 417
and more...

part K005

torque M14 = 80 Nm
M16x1,5 = 20 Nm
M24x1,5 = 40 Nm

1 DF 20 E-2

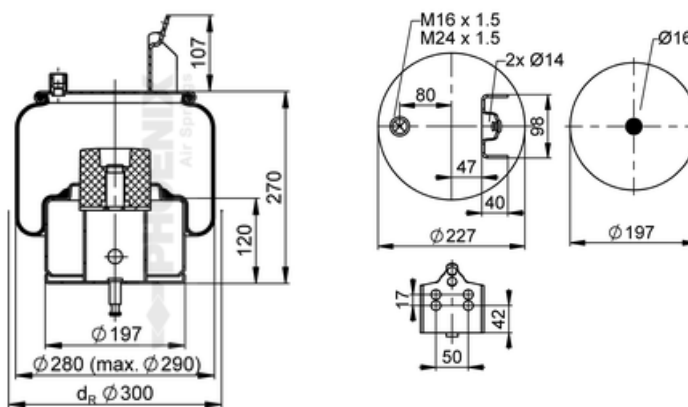

77385

kg 8 kg



for Volvo 21 977 974
Volvo 20 909 152

● bolt or stud ○ threaded hole ⊗ combination stud ⊗ air inlet

1 DF 20 F-1



4 054389 133329

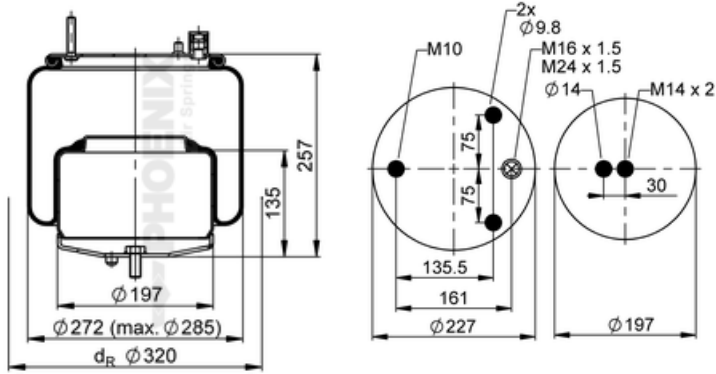

600812

kg 6,1



Volvo 22 058 738
Volvo 21 224 746



1 DF 20 G-1



4 054389 129735

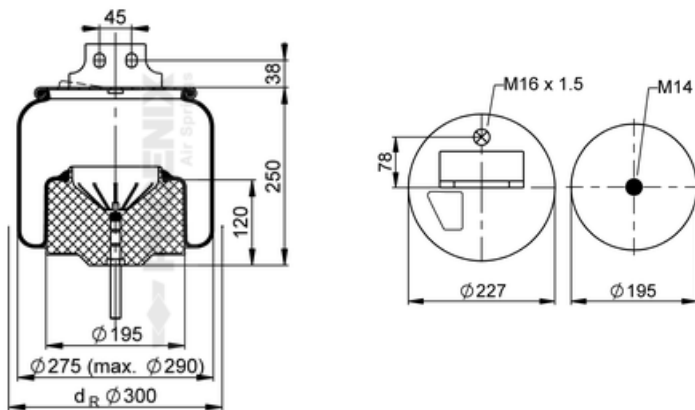

78692

kg 5,2



IVECO 500042583
IVECO 41270462

1 DF 20 G-1 NP



4 054389 129742

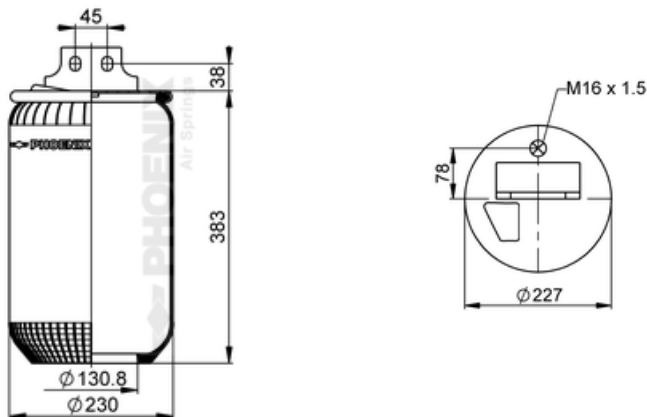

78693

kg 3,8

i service assembly

IVECO 42559765
IVECO 500042600

● bolt or stud ○ threaded hole ⊗ combination stud ⊗ air inlet



1 DF 20 G-2

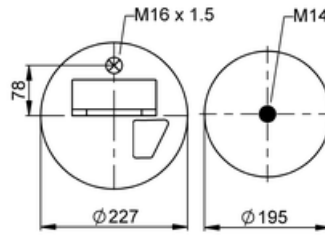
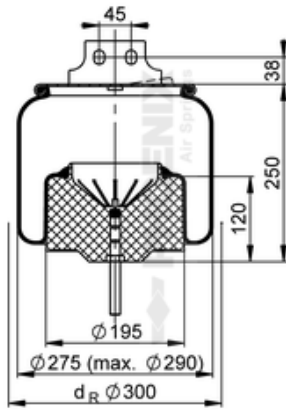

78694

kg 5,2 kg



IVECO 41270463
IVECO 500042584

1 DF 20 G-2 NP

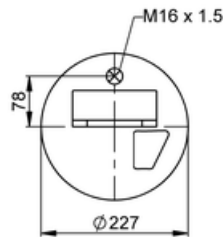
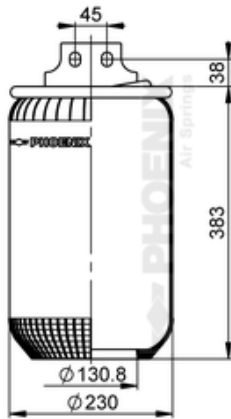

78695

kg 3,8 kg

i service assembly

IVECO 500042598
IVECO 42559766

1 DF 20 G-3

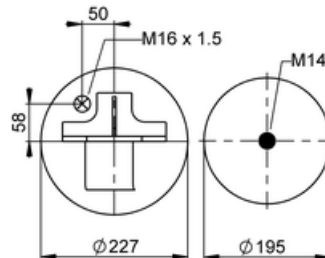
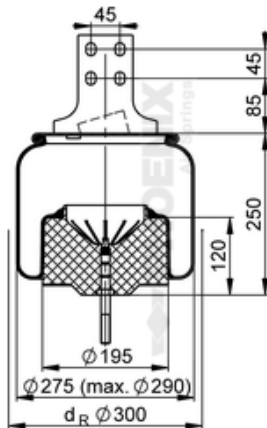

78696

kg 6 kg



IVECO 500042581
IVECO 41270465

● bolt or stud ○ threaded hole ⊗ combination stud ⊗ air inlet

1 DF 20 G-3 NP



4 054389 129780

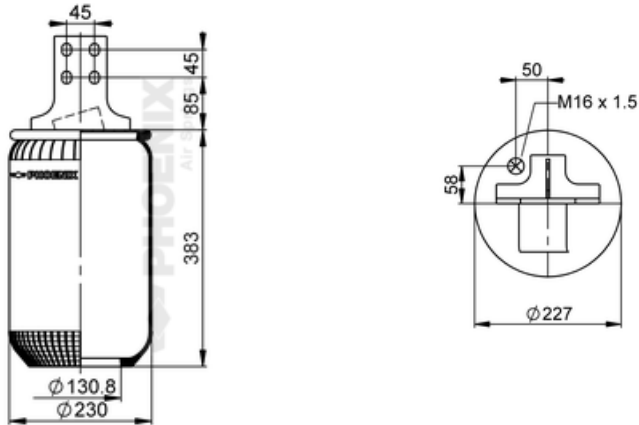

78697

kg 4.6 kg

i service assembly

tr IVECO 500042599
IVECO 42559767



1 DF 20 G-4



4 054389 129797

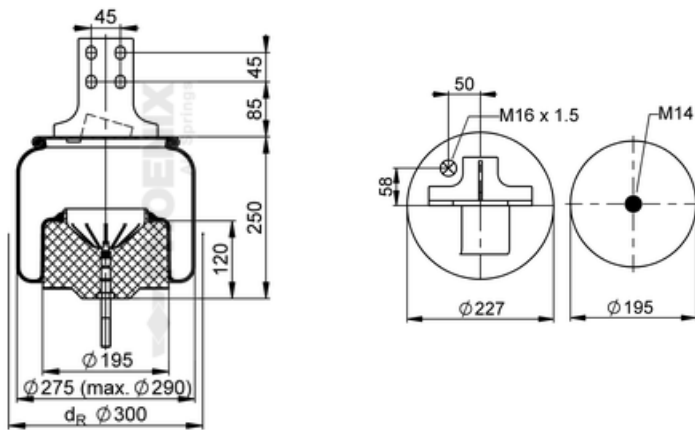

78698

kg 6 kg

i

tr IVECO 41270466
IVECO 500042582

1 DF 20 G-4 NP



4 054389 130007

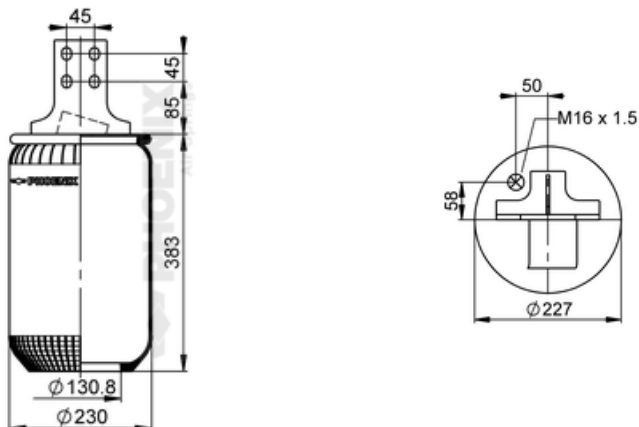

78699

kg 4.6 kg

i service assembly

tr IVECO 500042602
IVECO 42559768

● bolt or stud ○ threaded hole ⊗ combination stud ⊗ air inlet



1 DF 22 C-1



4 054389 109645

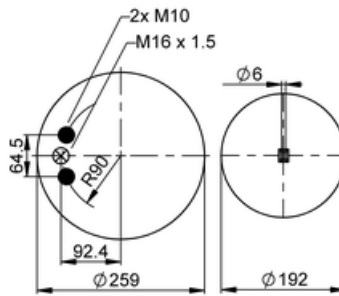
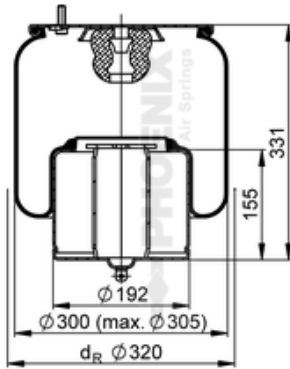

71755

kg 9,6 kg



Truck Volvo 20 554 755
Volvo 1 076 594

Spring K006

Wrench M10 = 35 Nm
M16x1,5 = 20 Nm

1 DF 22 C-1 NP



4 054389 127175

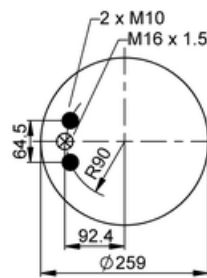
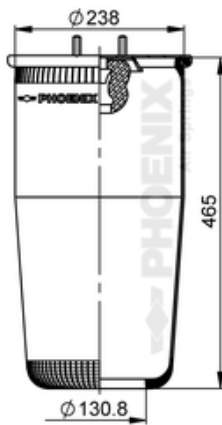

77386

kg 4,4 kg

i service assembly

Truck Volvo 1 076 595

Spring K006

1 DF 23 A-1



4 054389 112768

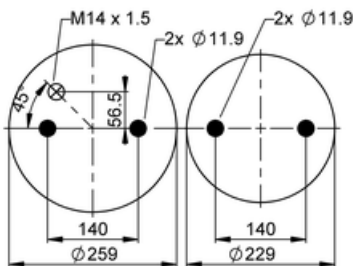
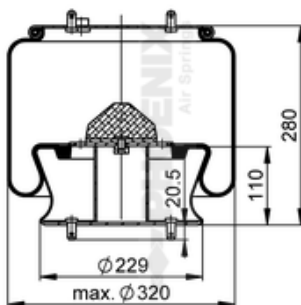

72067

kg 8,8 kg



Truck Scania 1440302

Spring K031

Wrench M14x1,5 = 20 Nm

● bolt or stud ○ threaded hole ⊗ combination stud ⊗ air inlet

1 DF 23 A-2



4 054389 116971

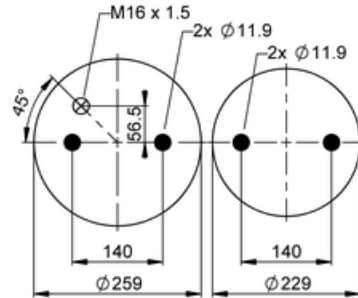
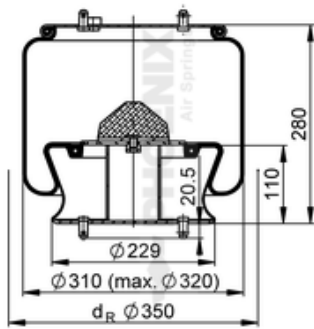

72488

kg 8,2



Bus Scania 1726238

Spring K031



1 DF 23 A-3



4 054389 116988

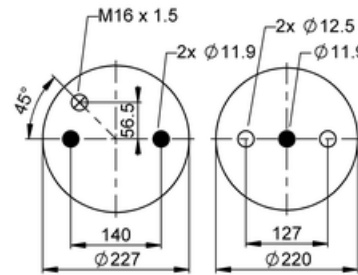
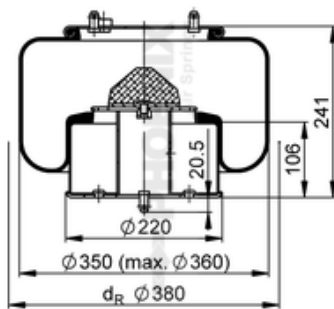

72489

kg 7,7



Bus Scania 1440308
Scania 1726247

Spring K031

1 DF 23 A-4



4 054389 127144

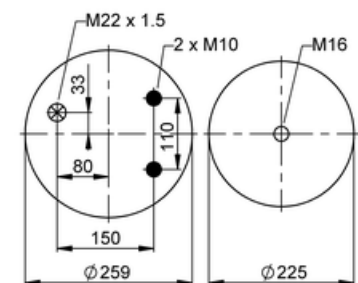
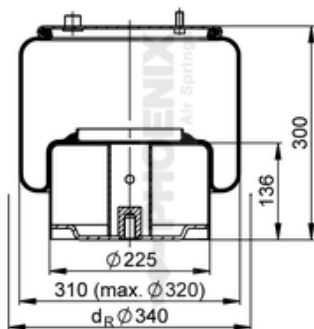

77383

kg 8,3



Truck DAF 1 794 420

Spring K008

● bolt or stud ○ threaded hole ⊗ combination stud ⊗ air inlet



1 DF 23 B-1



4 054389 112775

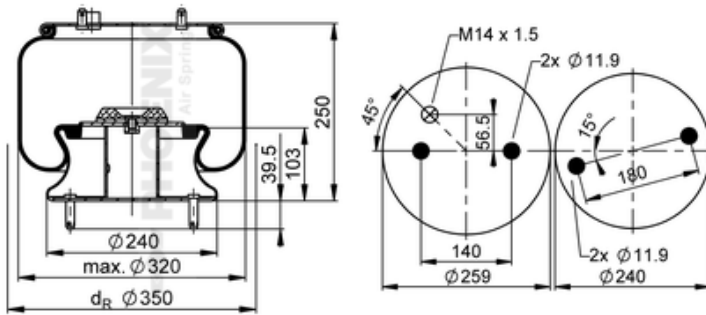

72068

8,3 kg



Scania 1440301

K031

$M14 \times 1,5 = 20 \text{ Nm}$

1 DF 23 B-2



4 054389 112782

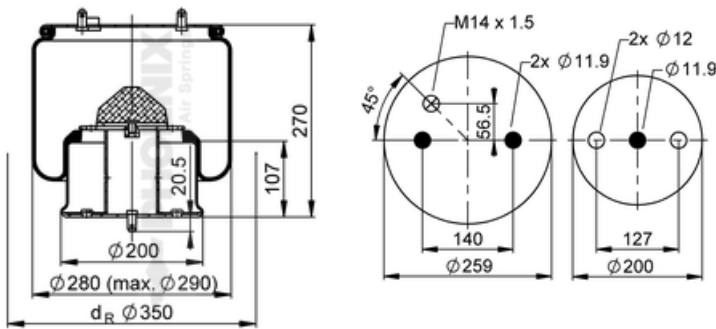

72069

7,2 kg



Scania 1440860
Scania 1440307

K031

$M14 \times 1,5 = 20 \text{ Nm}$

1 DF 23 B-3



4 054389 115523

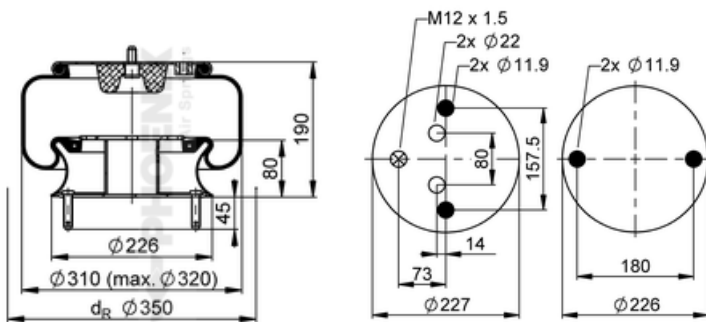

72343

7,2 kg



Scania 1386198

K031

$M12 \times 1,5 = 35 \text{ Nm}$

● bolt or stud ○ threaded hole ⊗ combination stud ⊗ air inlet

1 DF 23 B-4



4 054389 116995

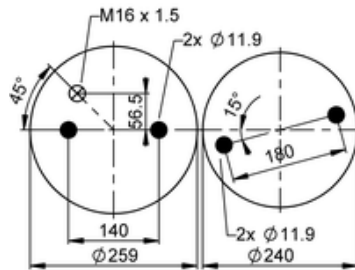
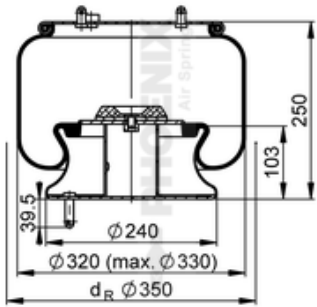

72490

kg 7.7 kg



Bus Scania 2024281
Scania 1726237

Bolt K031



1 DF 23 B-5



4 054389 117008

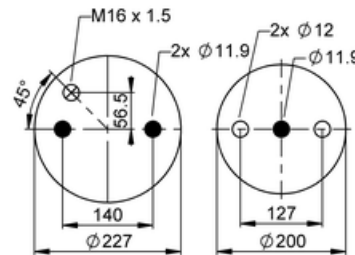
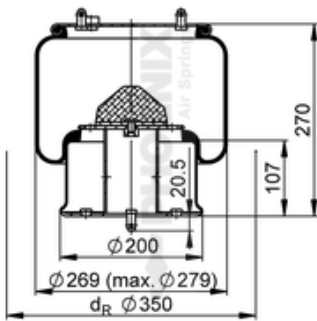

72491

kg 7 kg



Bus Scania 1726246

Bolt K031

1 DF 23 C-1



4 054389 115509

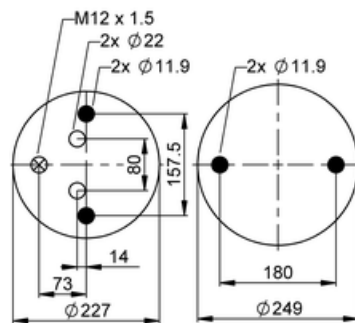
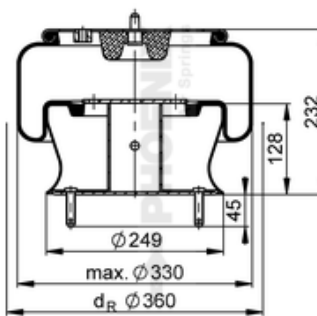

72341

kg 9.2 kg



Bus Scania 1386199
Scania 1370743
Scania 1362145

Bolt K031

Wrench M12x1,5= 35 Nm

● bolt or stud ○ threaded hole ⊗ combination stud ⊗ air inlet



1 DF 23 C-2

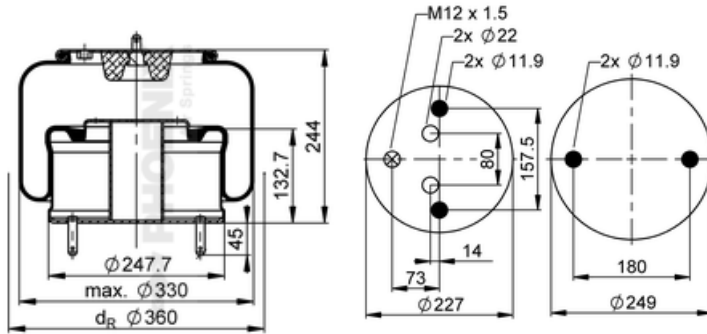

78323

9 kg



Scania 1942148

K031

1 DF 23 D-1

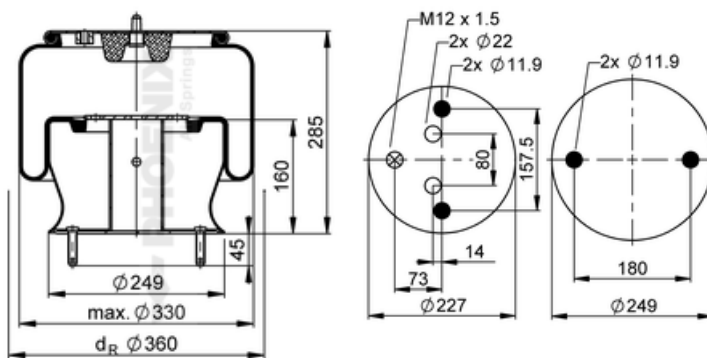

72342

10 kg



Scania 1386200
Scania 1370744
Scania 1362147

K031

M12x1,5= 35 Nm

1 DF 23 G-1

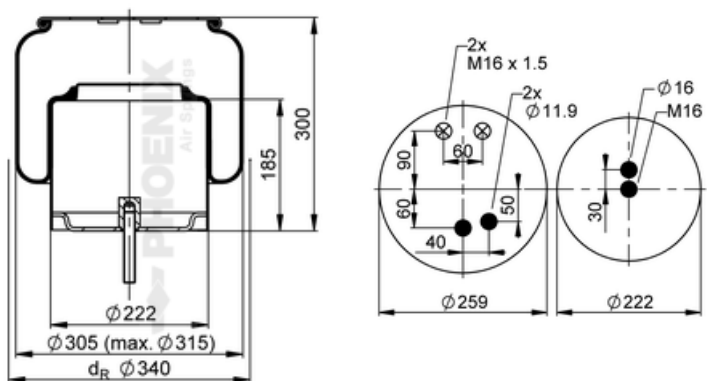

74995

8,9 kg



Scania 1932593
Scania 1434933

● bolt or stud ○ threaded hole ⊗ combination stud ⊗ air inlet

1 DF 25 A-1



4 054389 105319

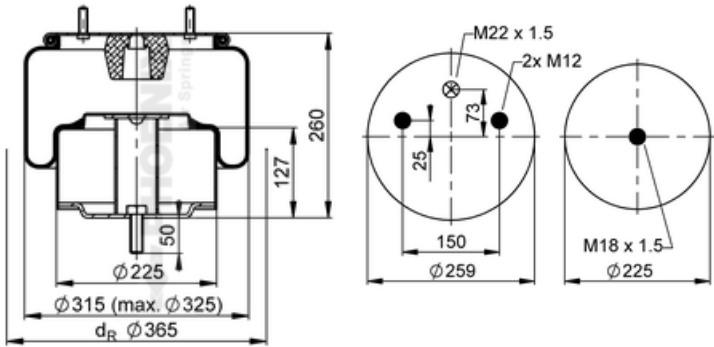

71322

kg 8,9



Bus Solaris 020701-0000-392-836
Solaris P-1001 101 060
Solaris P-1070 002 000
Solaris 1070 002 000
Solaris 1001 101 060

Spring K007

Wrench M12 = 70 Nm
M18x1,5 = 130 Nm
M22x1,5 = 20 Nm



1 DF 25 A-1 NP



4 054389 113826

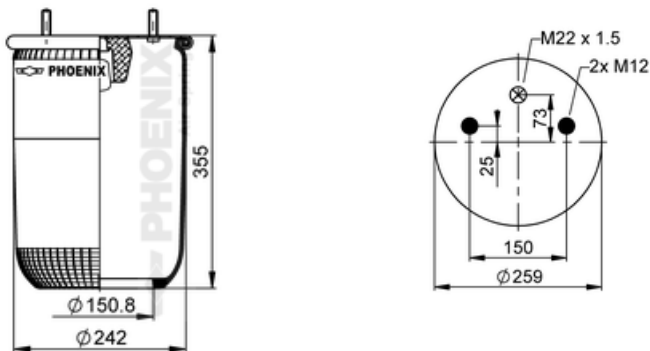

72173

kg 6,2

i SA for A-1,-2,-7,-8

Bus Solaris P-1001 101 058
Solaris 1001 101 058

Spring K007

Wrench M12 = 70 Nm
M22x1,5 = 20 Nm

1 DF 25 A-11



4 054389 110191

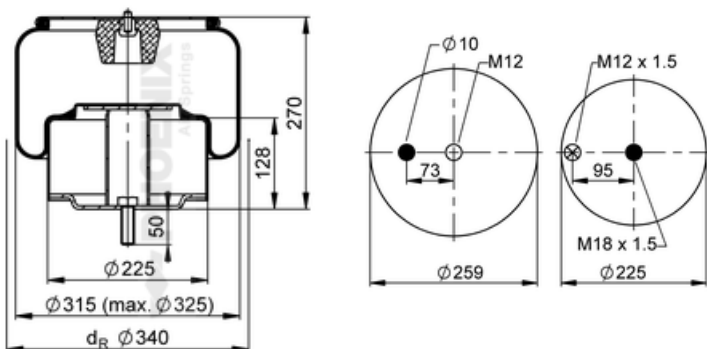

71810

kg 9,7



Bus Solaris 020701-0000-392-840
Solaris 1001 101 052
Solaris P-1001 101 052

Wrench M12 = 70 Nm
M18x1,5 = 130 Nm
M22x1,5 = 20 Nm

● bolt or stud ○ threaded hole ⊗ combination stud ⊗ air inlet



1 DF 25 A-12

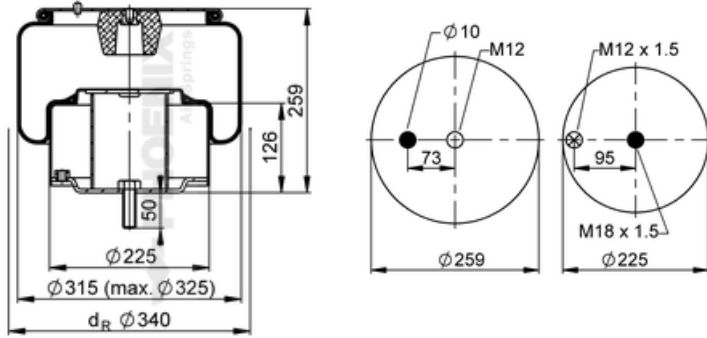

72459

kg 9,1 kg



- Solaris 1001 101 042
- Solaris 1001 101 045
- Solaris P-1001 101 042
- Solaris P-1001 101 045

1 DF 25 A-2

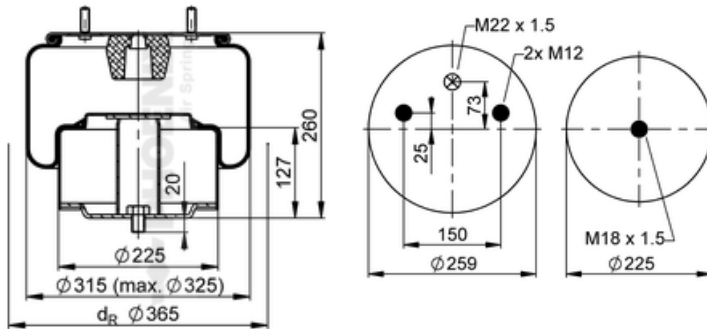

71338

kg 8,6 kg



- Solaris P-1070 001 000
- Solaris P-1001 101 040
- Solaris P-1001 101 050
- Solaris 1070 001 000
- Solaris 1001 101 040
- Solaris 1001 101 050
- Solaris 020701-0000-392-842

K007

M12 = 70 Nm
M18x1,5 = 130 Nm
M22x1,5 = 20 Nm

1 DF 25 A-20

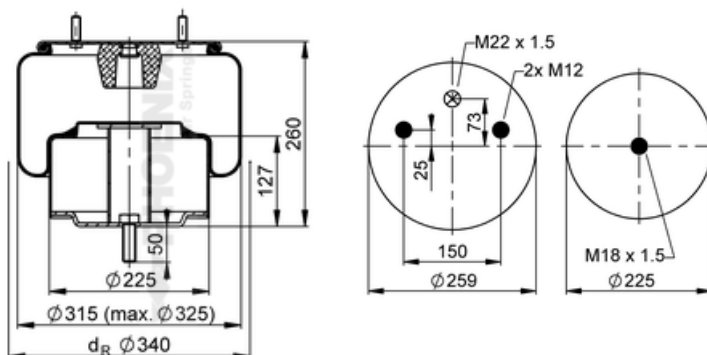

73436

kg 9,5 kg



- Solaris 0000 194 647
- Solaris P-0000 194 647

K007

● bolt or stud ○ threaded hole ⊗ combination stud ⊗ air inlet

1 DF 25 A-21



4 054389 121173

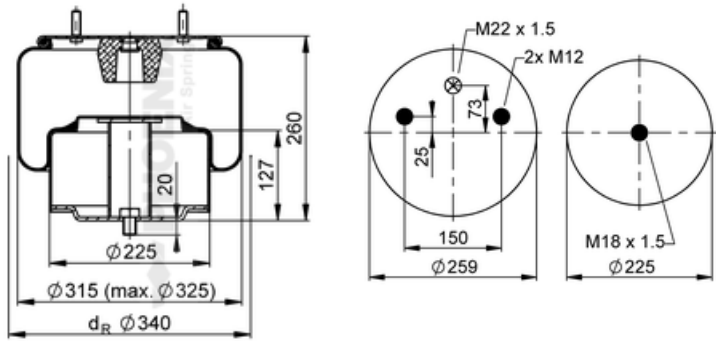

73437

9,5 kg

Solaris 0000 194 642
Solaris P-0000 194 642

K007



1 DF 25 A-22



4 054389 121180

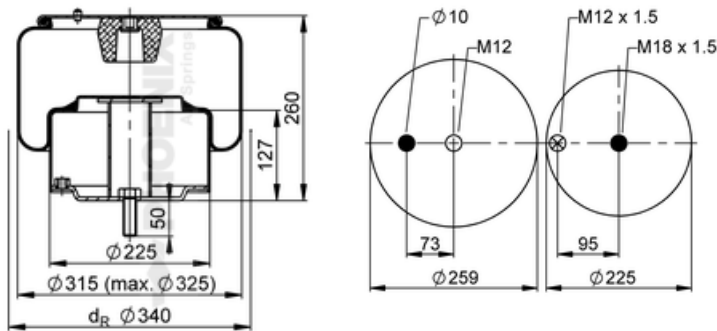

73438

9,5 kg

Solaris 0000 194 640
Solaris P-0000 194 640

1 DF 25 A-30

new



4 054389 137617

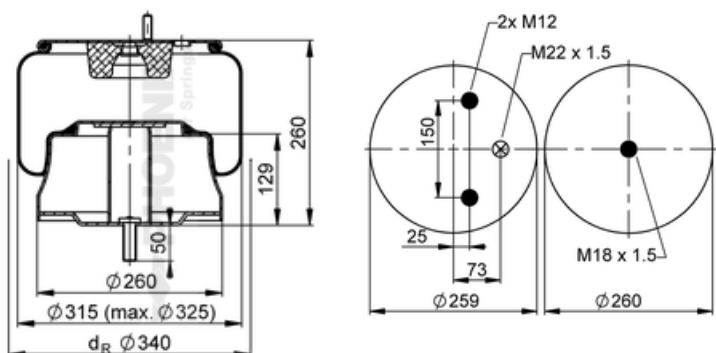

55075

9,9 kg

● bolt or stud ○ threaded hole ⊗ combination stud ⊗ air inlet



1 DF 25 A-31

new



4 054389 137600

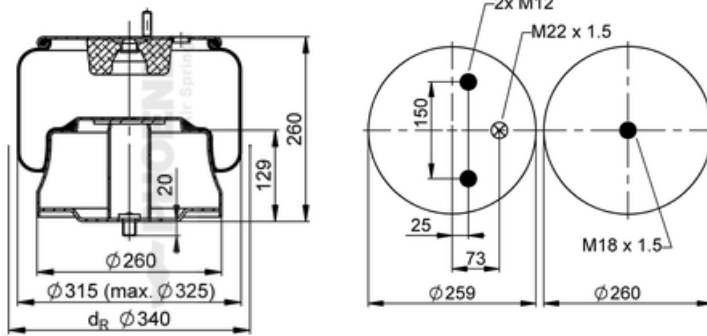

55076

9,8 kg



1 DF 25 A-7



4 054389 116674

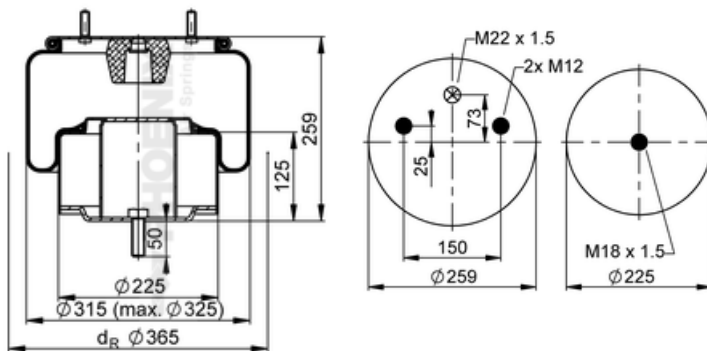

72458

9,3 kg



Solaris 1001 101 047
Solaris 1001 101 044
Solaris P-1001 101 044
Solaris P-1001 101 047

K007

1 DF 25 B-1 NP



4 054389 114793

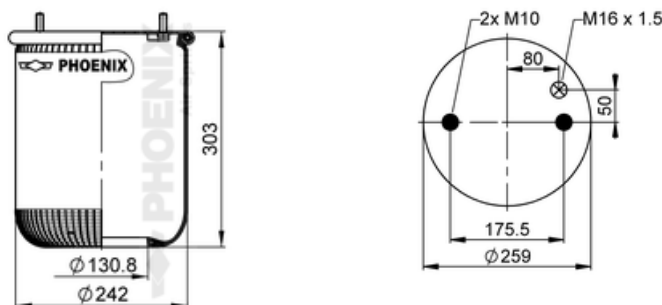

72270

3,4 kg

service assembly

Volvo 21 057 939
Volvo 20 703 452

M10 = 35 Nm
M16x1,5 = 20 Nm

● bolt or stud ○ threaded hole ⊗ combination stud ⊗ air inlet

1 DF 25 C-1



4 054389 126512

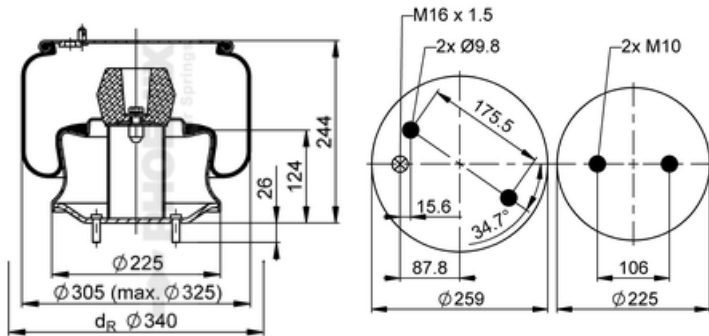

76823

kg 9 kg

i

Volvo 21 513 833
Volvo 21 097 433
Volvo 21 057 936
Volvo 70 311 683



1 DF 25 C-1 NP



4 054389 123405

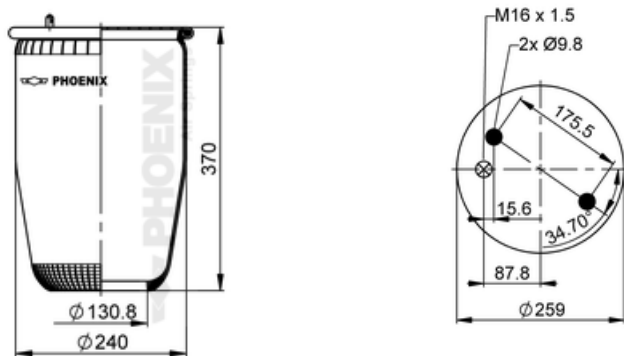

74783

kg 3,3 kg

i service assembly for C-1

Volvo 21 513 836

K024

1 DF 25-1 NP



4 054389 105197

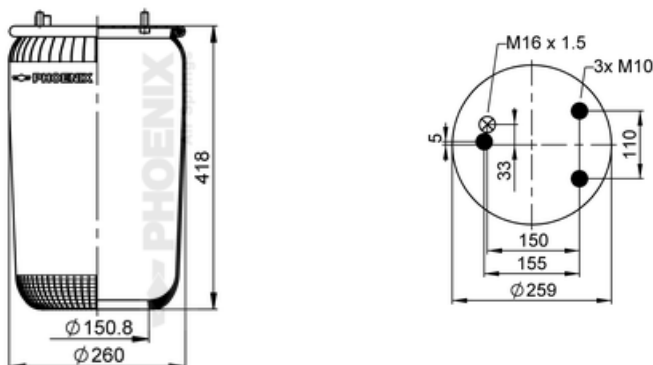

71310

kg 3,6 kg

i SA for 1 DF 25-11;12

DAF 0 067 504
 VDL Bus 0 067 504

M10 = 35 Nm
M16x1,5 = 20 Nm

● bolt or stud ○ threaded hole ⊗ combination stud ⊗ air inlet



1 DF 25-11

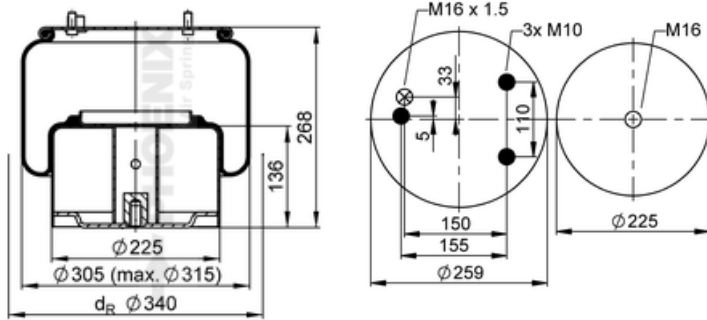

71313

- 8,8 kg

-

- DAF 1 697 678
DAF 0 388 165
DAF 1 529 833

- K008

- M10 = 35 Nm
M16x1,5 = 20 Nm
M16 = 130 Nm

1 DF 25-13

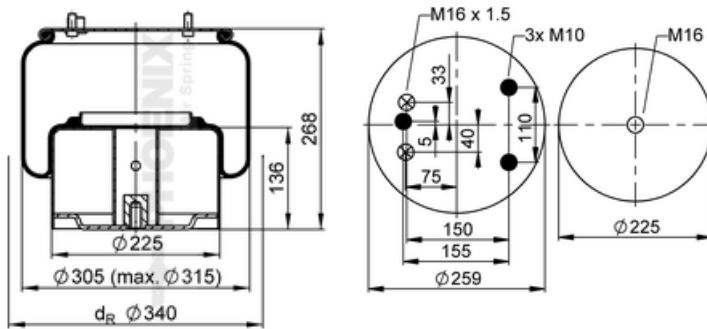

71314

- 9 kg

-

- DAF 0 388 167

- K008

- M10 = 35 Nm
M16x1,5 = 20 Nm
M16 = 130 Nm

1 DF 25-14

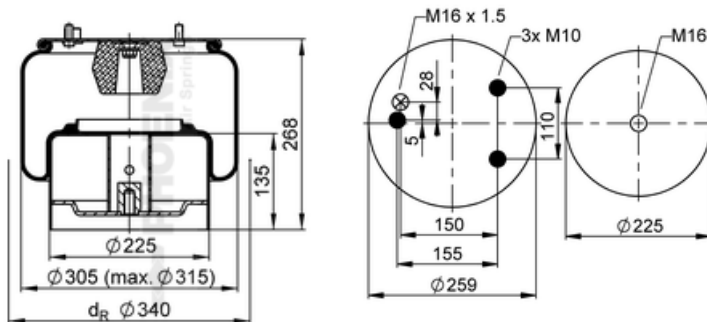

71315

- 9,4 kg

-

- VDL Bus 0 377 498

- K008

- M10 = 35 Nm
M16x1,5 = 20 Nm
M16 = 130 Nm

● bolt or stud ○ threaded hole ⊗ combination stud ⊗ air inlet

1 DF 25-15



4 054389 105326

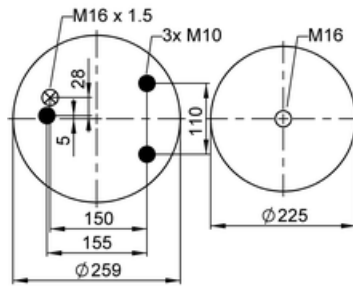
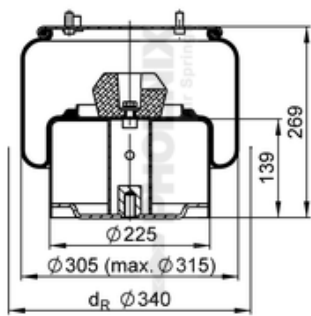

71323

kg 9,6

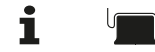

VDL Bus 0 526 651

K008

M10 = 35 Nm
M16x1,5 = 20 Nm
M16 = 130 Nm



1 DF 25-3 NP



4 054389 105203

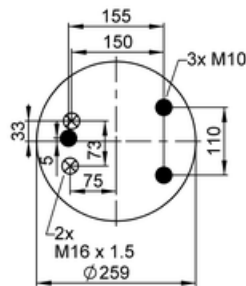
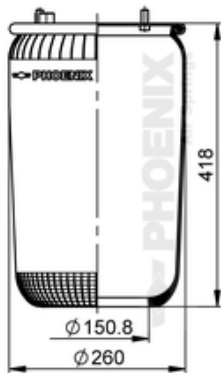

71311

kg 3,6

i SA for 1 DF 25-13

DAF 0 513 982
VDL Bus 0 513 982

M10 = 35 Nm
M16x1,5 = 20 Nm

1 DF 32-1



4 054389 127151

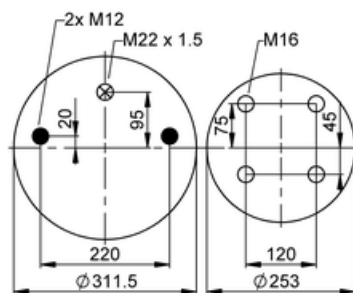
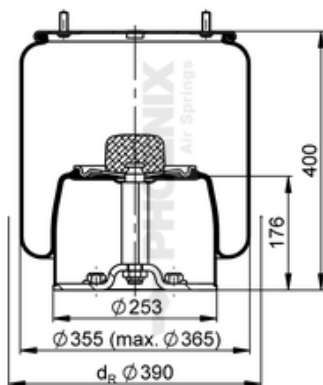

77384

kg 15

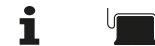

Gigant 3653 compl.
Gigant 166252
Gigant 700166252

● bolt or stud ○ threaded hole ⊗ combination stud ⊗ air inlet



1 DK 18 A-1



4 054389 123429

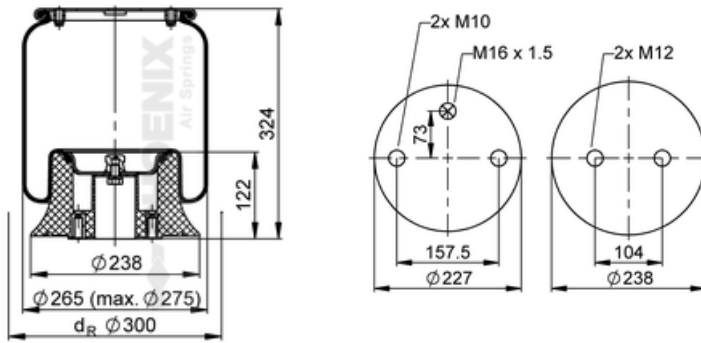

74785

4.8 kg



Scania 1865759
Scania 1402423
Scania 1394997
Scania 1314903

1 DK 19-1



4 054391 108698

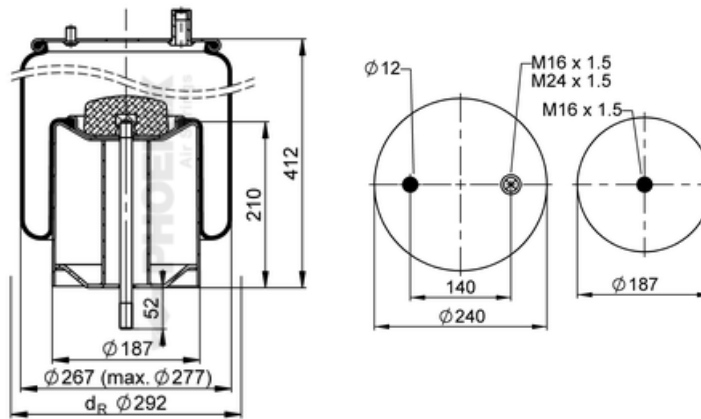

73014

10,1 kg



Renault 7.422.190.563
Renault 22 190 563
Renault 5.010.488.070
Renault 5.010.294.309
Volvo 22 025 613
SAMRO H2501122

M16x1,5 = 20/80 Nm
M24x1,5 = 100 Nm

1 DK 20 A-1



4 054389 105159

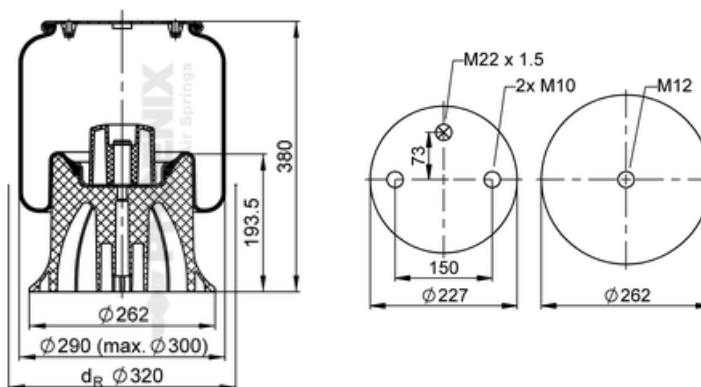

71306

6,6 kg



Schmitz 751 065
Weweler US 06316
Scania 2198333
Weweler YPO6316F

K009

M10 = 35 Nm
M12 = 40 Nm
M22x1,5 = 20 Nm

● bolt or stud ○ threaded hole ⊗ combination stud ⊗ air inlet

1 DK 20 A-51



4 054389 107375

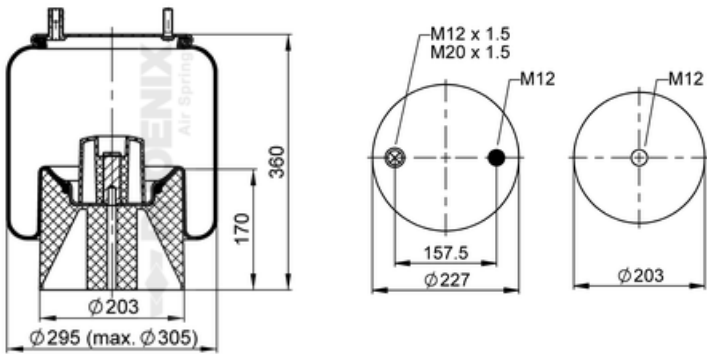

71528

kg 6 kg



SMB M060924
Fruehauf UJB 0975
Acerbi 128140028
Acerbi 800449526

kg K010

kg M12 = 70 Nm
M20x1,5 = 20 Nm



1 DK 20 B-1



4 054389 105173

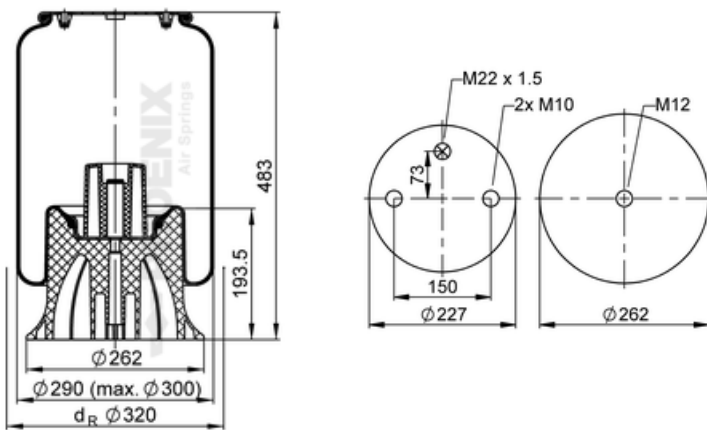

71308

kg 7.2 kg



Schmitz 014 892
Schmitz 750 999
Weweler US 06285
Scania 2198334
Weweler YP06285F

kg K009

kg M10 = 35 Nm
M12 = 40 Nm
M22x1,5 = 20 Nm

1 DK 20 B-1 NP



4 054389 108921

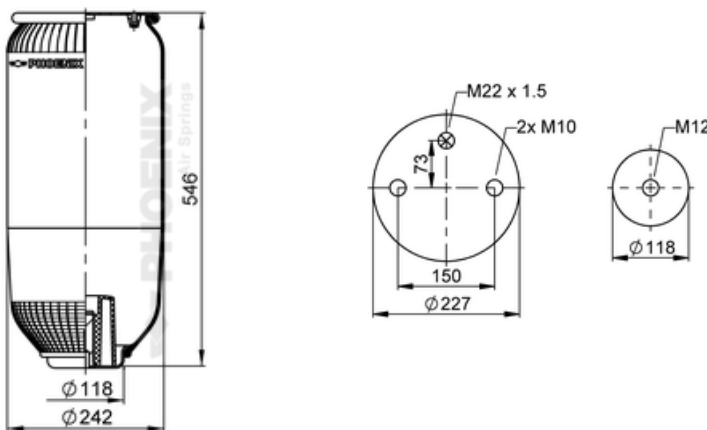

71683

kg 5.1 kg

i SA for B-1

kg Schmitz

kg K009

kg M10 = 35 Nm
M12 = 40 Nm
M22x1,5 = 20 Nm

● bolt or stud ○ threaded hole ⊗ combination stud ⊗ air inlet



1 DK 20 C-2



4 054389 107313

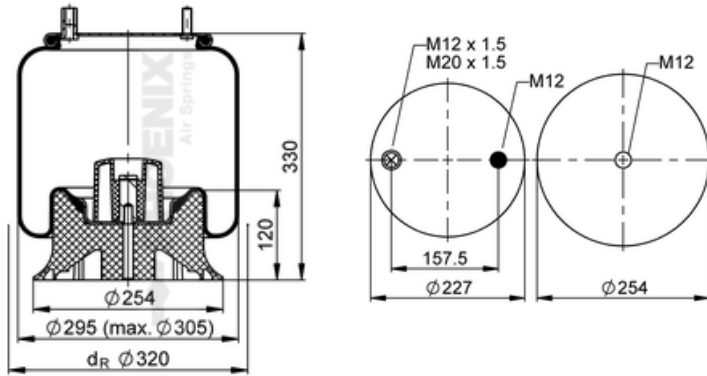

71522

kg 5,4 kg



Truck Fruehauf UJB 1180/B
Neway 905 572 33
SAMRO H2501869
SMB M078580

Wrench M12 = 70 Nm
M20x1,5 = 40 Nm

1 DK 20 C-5



4 054389 108570

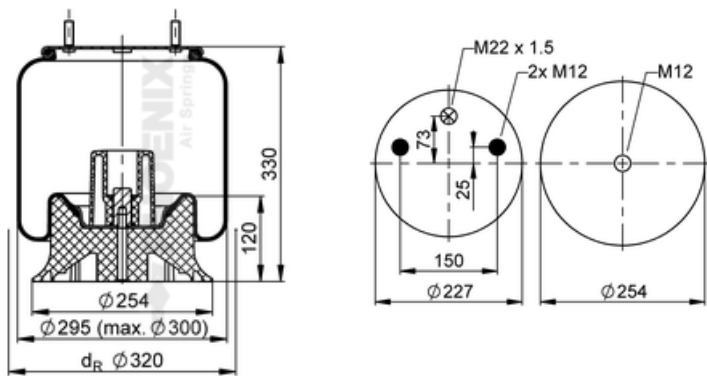

71648

kg 5,4 kg



Truck KRONE 515069174
KRONE 09377003
Gigant 700196084
Gigant 196084
Gigant 709377003

1 DK 21



4 054389 109317

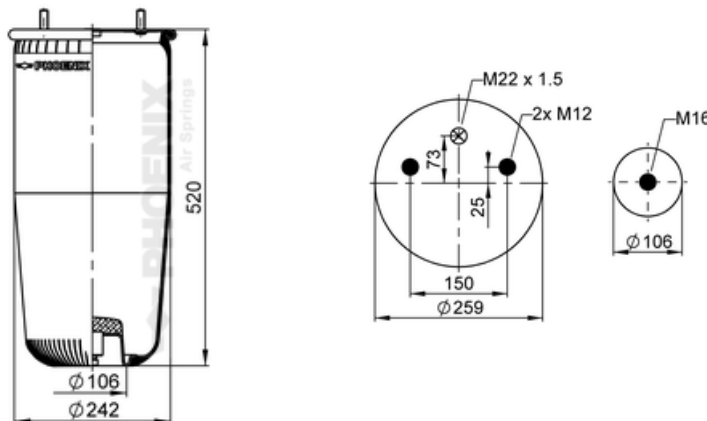

71722

kg 4,9 kg

i SA for 1 DK 21-1,-2,-4

Truck BPW 05.429.40.03.0
Schmitz 015 514

Bolt K029

Wrench M12 = 70 Nm
M16 = 130 Nm
M22x1,5 = 20 Nm

● bolt or stud ○ threaded hole ⊗ combination stud ⊗ air inlet

1 DK 21 A-3



4 054389 108679

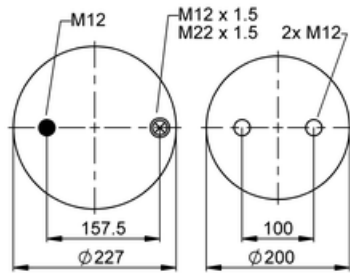
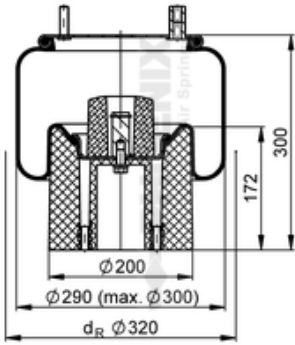

71658

kg 6,2 kg



Weweler US 07074C
Weweler US 07074P
Weweler US 08840

K025

M12 = 70 Nm
M22x1,5 = 20 Nm



1 DK 21 A-31



4 054389 108709

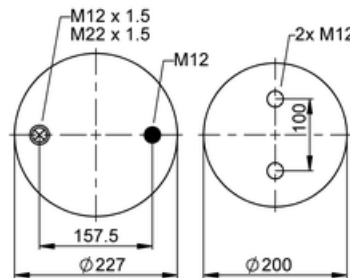
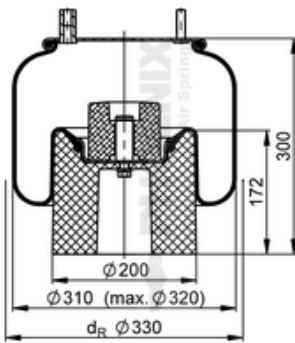

71661

kg 6 kg



Meritor 2122 2442
SMB 09377012
Weweler YP07074W
Weweler US 07074F

K025

M12 = 70 Nm
M22x1,5 = 20 Nm

1 DK 21 A-4



4 054389 108686

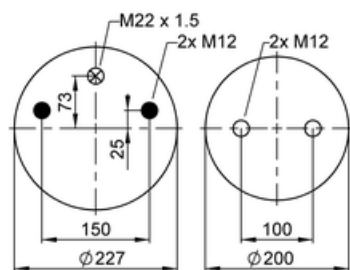
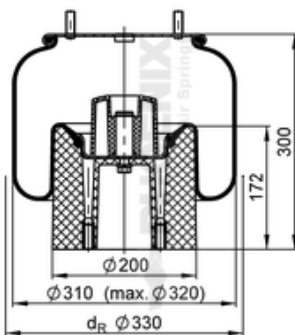

71659

kg 6 kg



Weweler US 87EUROF
Weweler US 07364F
Weweler YP07364F
Weweler US 06287

K011

M12 = 70 Nm
M22x1,5 = 20 Nm

● bolt or stud ○ threaded hole ⊗ combination stud ⊗ air inlet



1 DK 21 A-4 NP



4 054389 127854

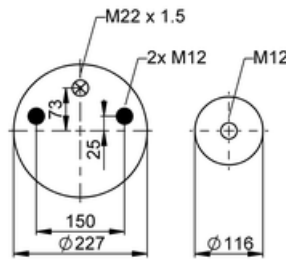
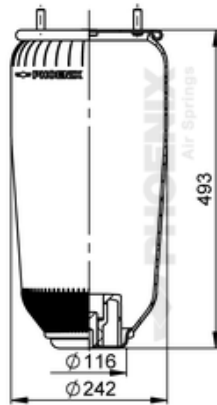

77752

kg 4.3 kg

i service assembly for A-4

🚚 Meritor
Weweler

1 DK 21 A-9



4 054389 108693

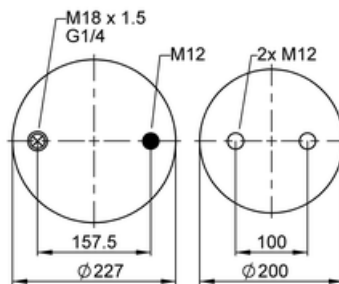
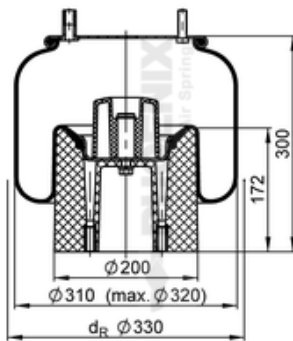

71660

kg 6.2 kg

i

🚚 Hüferrmann 1613400

🔧 M12 = 70 Nm
M18x1,5 = 40 Nm

1 DK 21 B-4



4 054389 105784

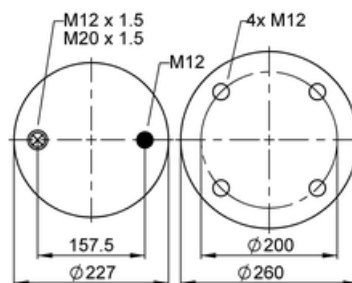
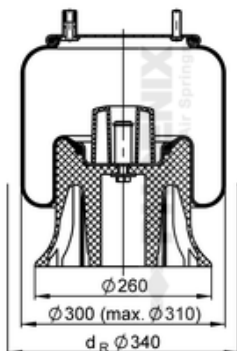

71369

kg 6.5 kg

i

🚚 Montenegro

🔧 K015

🔧 M12 = 70 Nm
M20x1,5 = 40 Nm

● bolt or stud ○ threaded hole ⊗ combination stud ⊗ air inlet

1 DK 21 B-5 NP

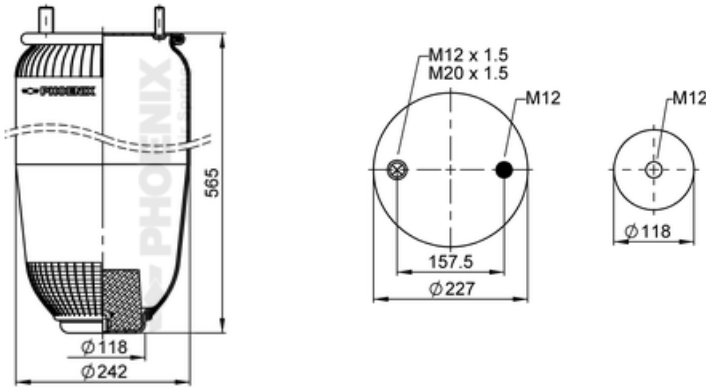

71377

kg 4,8 kg

i service assembly

🚚 Fruehauf

🔧 M12 = 70 Nm
M20x1,5 = 40 Nm



1 DK 21 C-4

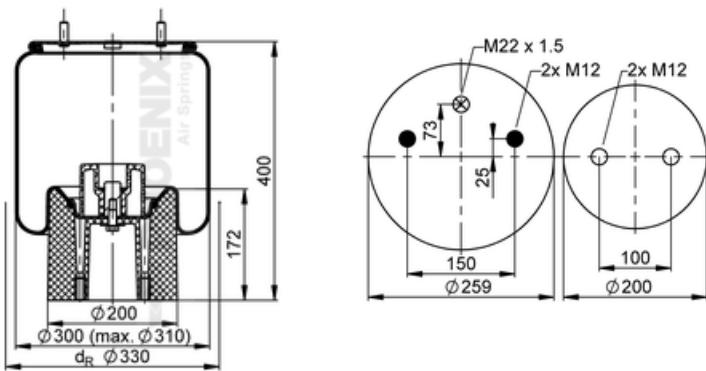

78137

kg 6,5 kg

i

🚚 Daimler TAS A 946 328 14 01
Daimler TAS 946 328 14 01
Jost 30 105 014 01
Jost JAS 30 105 014 01
Jost JAE 30 105 014 01
Meritor 2122 1307

🔩 K011

1 DK 21 C-5

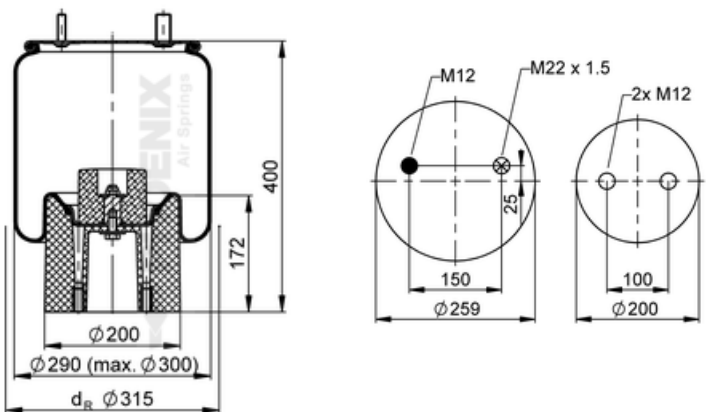

600810

kg 6,5 kg

i

🚚 Daimler TAS A 946 328 25 01
Jost JAE 30 105 025 01
Jost JAS 30 105 025 01
Jost 3010502501

● bolt or stud ○ threaded hole ⊗ combination stud ⊗ air inlet



1 DK 21 K

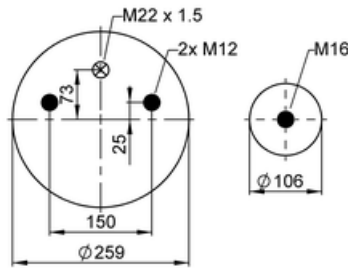
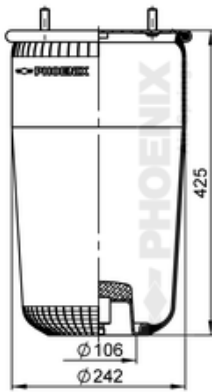

71721

	4,5 kg
	SA for K-1, K-2, K-4
	BPW 05.429.40.91.0 Schmitz 013 769
	Scania 2406164
	K029
	M12 = 70 Nm M16 = 130 Nm M22x1,5 = 20 Nm

1 DK 21 K-1

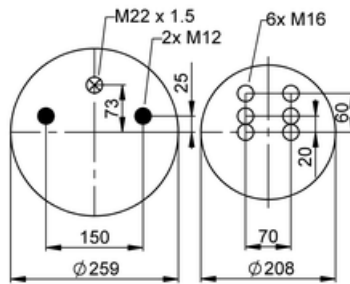
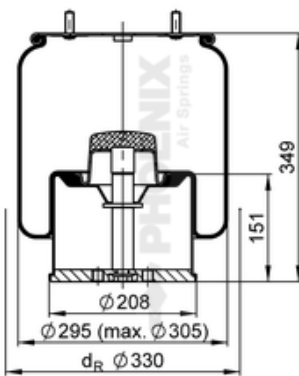

71931

	11,8 kg
	BPW 05.429.41.23.1
	K029
	M12 = 70 Nm M16 = 70 Nm M22x1,5 = 20 Nm

1 DK 21 K-2

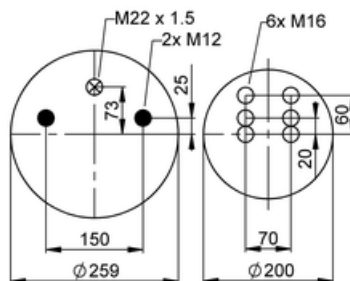
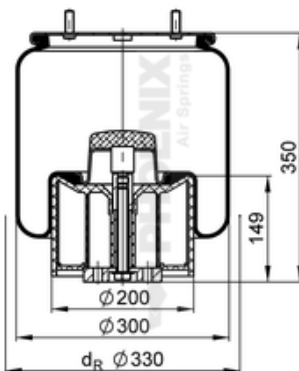

72327

	8,8 kg
	BPW 05.429.43.21.0 BPW 05.429.43.37.0 Schmitz 751 084 Schmitz 017 331
	Scania 2198483
	K029
	M12 = 70 Nm M16 = 70 Nm M22x1,5 = 20 Nm

● bolt or stud ○ threaded hole ⊗ combination stud ⊗ air inlet

1 DK 21 K-3



4 054389 109355

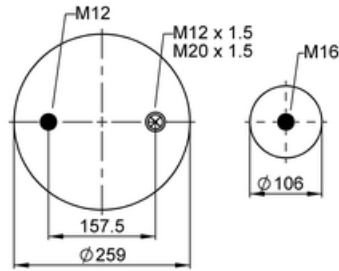
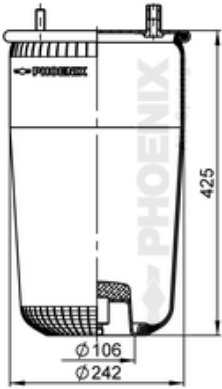

71726

kg 4,5

i service assembly for K-3

BPW BPW 05.429.41.77.0

K026 K026

M12 = 70 Nm
M16 = 130 Nm
M20x1.5 = 40 Nm



1 DK 21 K-32



4 054389 127830

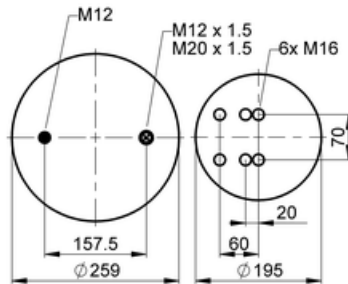
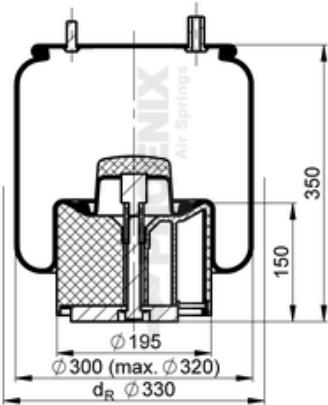

77750

kg 8,7

i

BPW BPW 05.429.43.23.0

1 DK 21 K-4



4 054389 122934

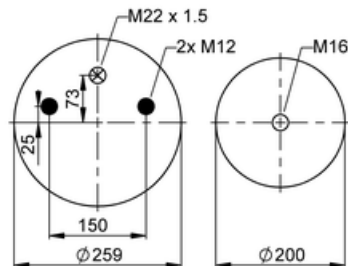
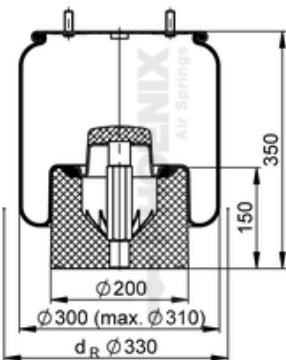

74299

kg 7

i

BPW BPW 05.429.43.86.0

● bolt or stud ○ threaded hole ⊗ combination stud ⊗ air inlet



1 DK 21-1



4 054389 111396

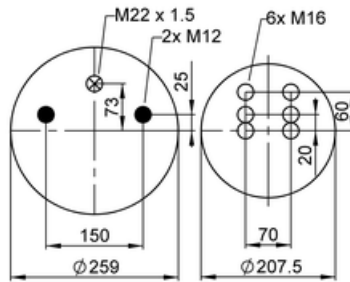
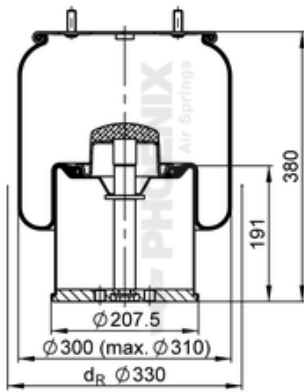

71930

kg 13 kg



BPW 05.429.41.24.1
BPW 05.429.43.34.0
BPW 05.429.43.56.0

kg K029

kg M12 = 70 Nm
M16 = 70 Nm
M22x1,5 = 20 Nm

1 DK 21-2



4 054389 115356

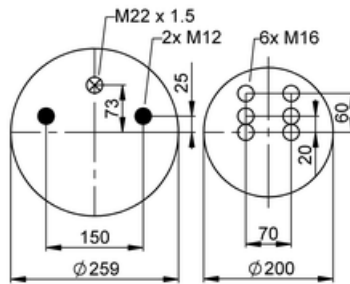
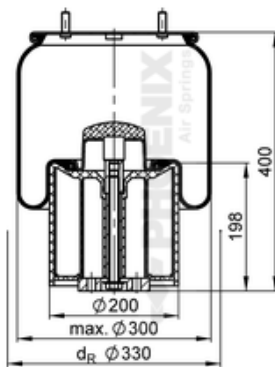

72326

kg 9,4 kg



BPW 05.429.43.20.0
Schmitz 017 109
Scania 2338887

kg K029

kg M12 = 70 Nm
M16 = 70 Nm
M22x1,5 = 20 Nm

1 DK 21-4



4 054389 122927

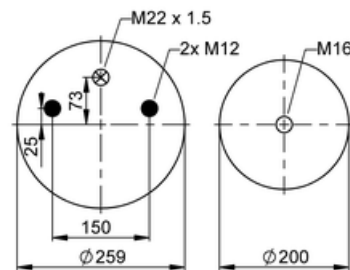
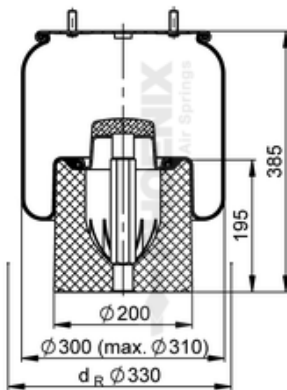

74298

kg 8 kg



BPW 05.429.43.85.0

● bolt or stud ○ threaded hole ⊗ combination stud ⊗ air inlet

1 DK 22 D-1



4 054389 118128

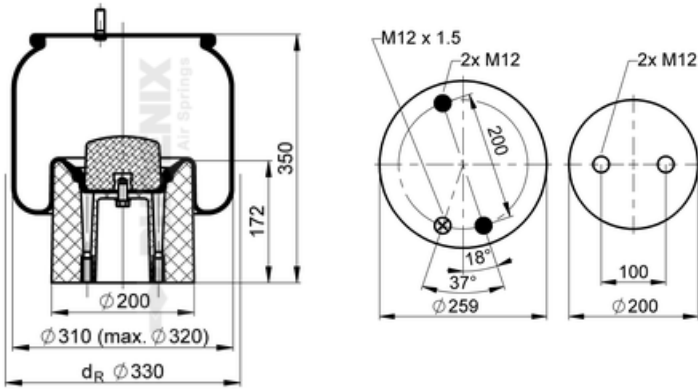

72603

kg 6,8 kg



Bevola 052360
Meritor 2122 9214



1 DK 22 D-2



4 054389 128639

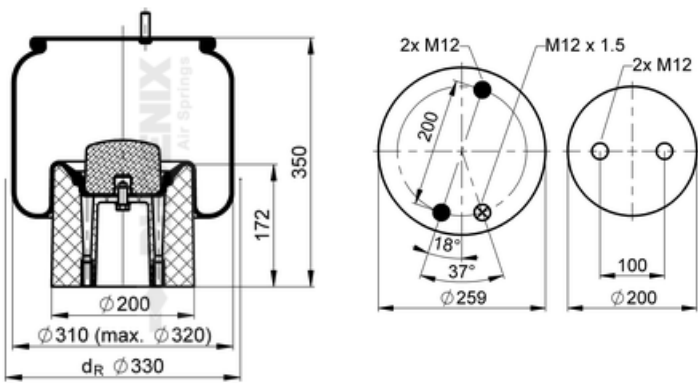

78141

kg 6,8 kg



Bevola 052361

1 DK 22 E-11



4 054389 111174

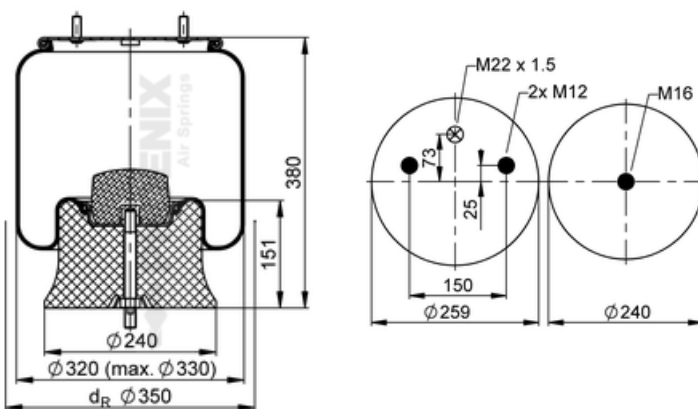

71908

kg 7 kg



SAF - Holland 2619V
SAF - Holland 3.229.0033.00
Scania 1723281

K013

M12 = 70 Nm
M16 = 130 Nm
M22x1,5 = 20 Nm

● bolt or stud ○ threaded hole ⊗ combination stud ⊗ air inlet



1 DK 22 E-13



4 054389 118463

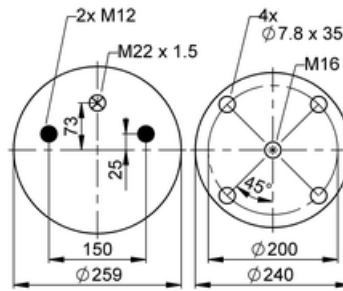
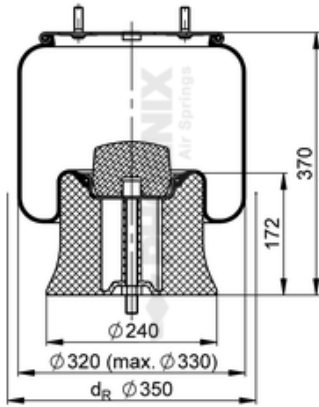

72637

kg 7,3 kg



SAF - Holland 2621V
SAF - Holland 3.229.0038.00

K013

1 DK 22 E-14



4 054389 118470

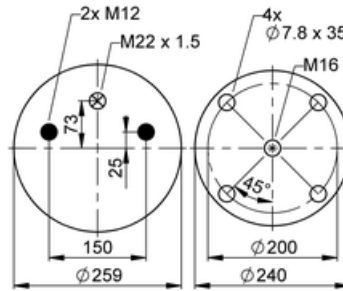
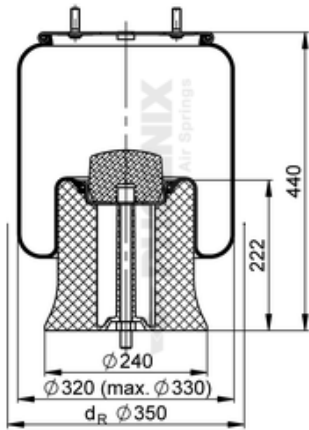

72638

kg 8 kg



SAF - Holland 2626V
SAF - Holland 3.229.0039.00
Kögel 360112

K013

1 DK 22 E-15



4 054389 124112

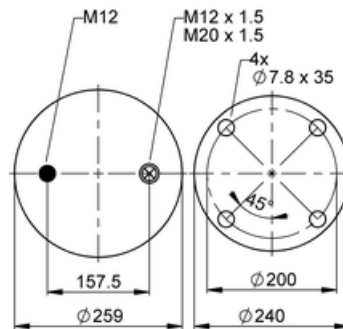
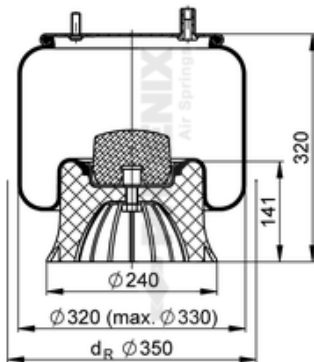

75056

kg 7,2 kg



SAF - Holland 2618L
SAF - Holland 3.229.0040.00

K014

● bolt or stud ○ threaded hole ⊗ combination stud ⊗ air inlet

1 DK 22 E-16



4 054389 128417

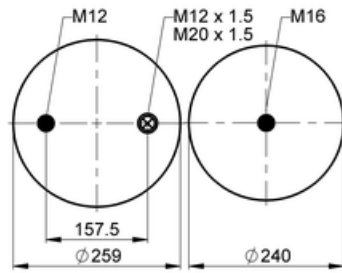
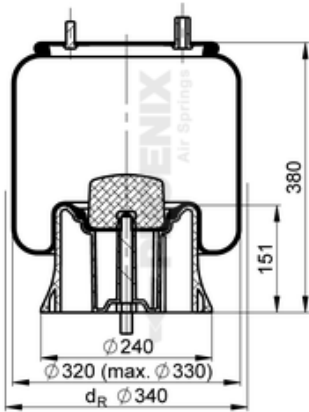

78066

kg 7 kg



SAF - Holland 2619L
SAF - Holland 3.228.1043.00
SAF - Holland 3.229.0043.00



1 DK 22 E-17



4 054389 128622

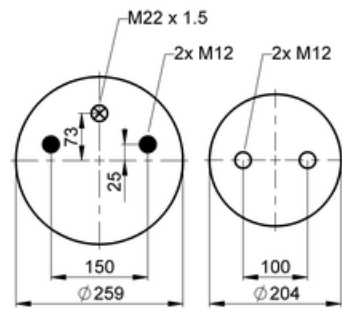
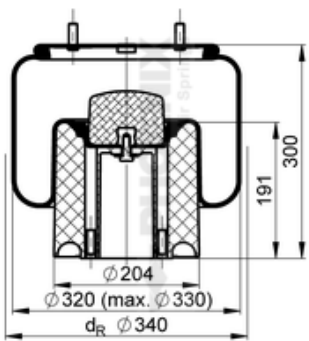

78140

kg 7 kg



Meritor 2123 0298

1 DK 22 E-5



4 054389 106408

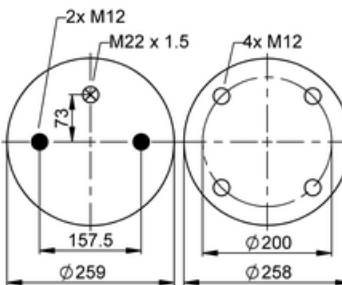
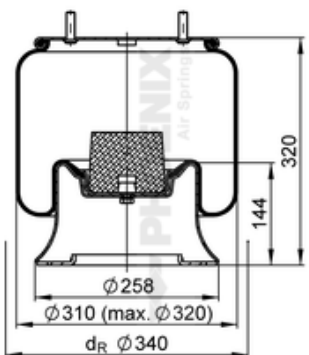

71431

kg 9,6 kg



SAF - Holland 2618(E5)
SAF - Holland 2.229.0007.00

K001

M12 = 70 Nm
M22x1,5 = 20 Nm

● bolt or stud ○ threaded hole ⊗ combination stud ⊗ air inlet



1 DK 22 E-8



4 054389 107481

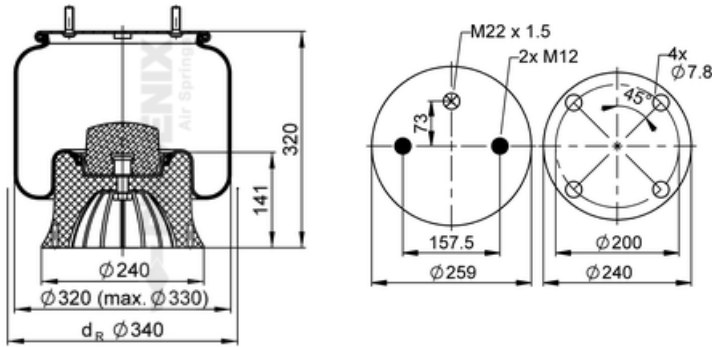

71539

kg 6,9 kg



SAF - Holland 2618
SAF - Holland 3.229.0007.00
SAF - Holland 3.229.0007.02
Scania 1723273

K014

M12 = 70 Nm
M22x1,5 = 20 Nm

1 DK 22 E-9



4 054389 107498

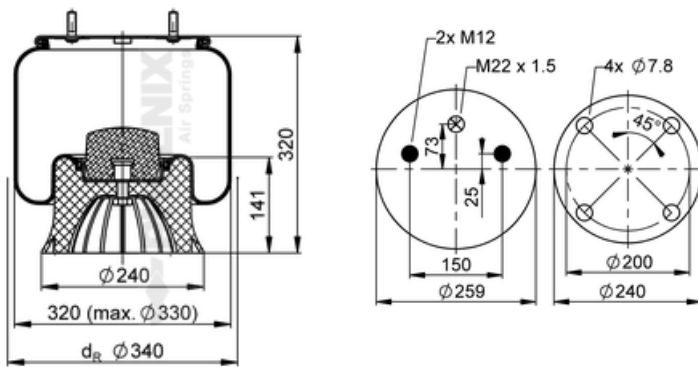

71540

kg 7,2 kg



SAF - Holland 2618V
SAF - Holland 3.229.0029.00
SAF - Holland 3.229.2129.00
SAF - Holland 3.229.2229.00
SAF - Holland 3.229.2429.00
Scania 1723277

K014

M12 = 70 Nm
M22x1,5 = 20 Nm

1 DK 22 E-9 NP



4 054389 107733

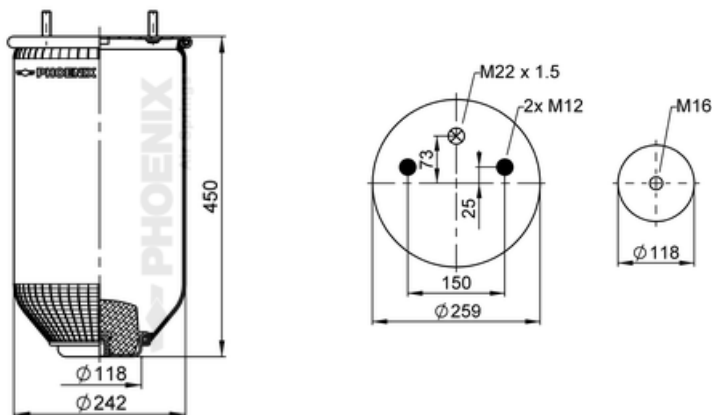

71564

kg 5 kg

i SA for E-9, -11, -13, -14

SAF - Holland 4.284.3006.00

K014

M12 = 70 Nm
M16 = 130 Nm
M22x1,5 = 20 Nm

● bolt or stud ○ threaded hole ⊗ combination stud ⊗ air inlet

1 DK 23 F-1



4 054389 107931

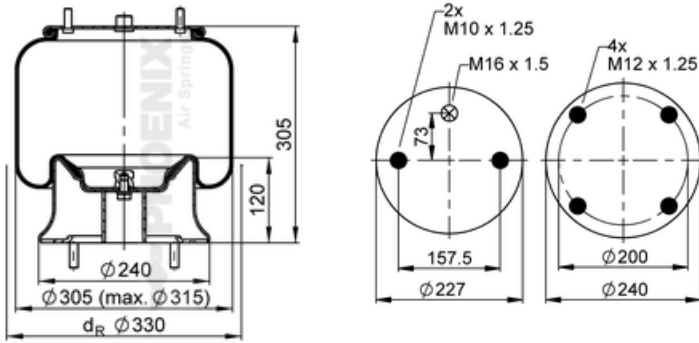

71584

kg 7,9



Renault 5.010.239.252
Renault 5.010.488.071

Wrench icon
M10x1,25 = 35 Nm
M12x1,25 = 40 Nm
M16x1,5 = 30 Nm



1 DK 23 H-0742



4 054389 105265

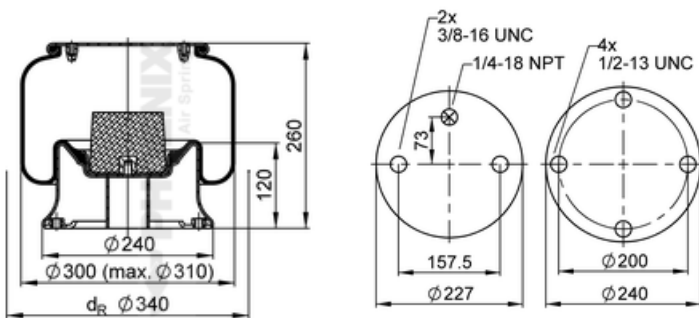

71317

kg 8,8



Austral Denning

Wrench icon
G 1/4 = 20 Nm
G 1/2 = 60 Nm
G 3/8 = 40 Nm

1 DK 23 K-1



4 054389 112805

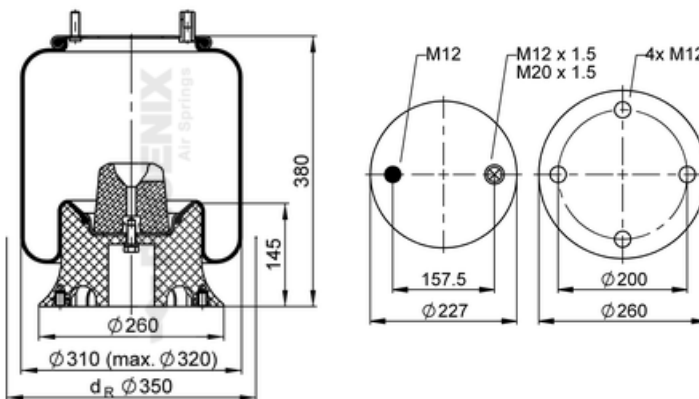

72071

kg 6,6



Meritor 2121 5761
Weweler US 35864
SMB
Hendrickson HA100001

Wrench icon
K015
M12 = 70 Nm
M20x1,5 = 80 Nm

● bolt or stud ○ threaded hole ⊗ combination stud ⊗ air inlet



1 DK 23 K-1 NP



4 054389 127847

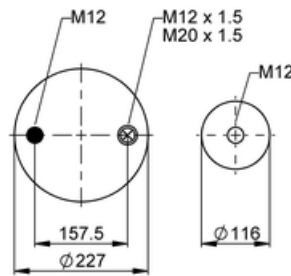
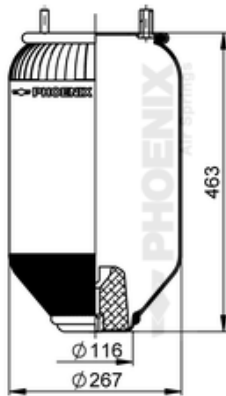

77751

4,6 kg

service assembly for K-1, K-28

Hendrickson
Meritor
Weweler

1 DK 23 K-28



4 054389 118692

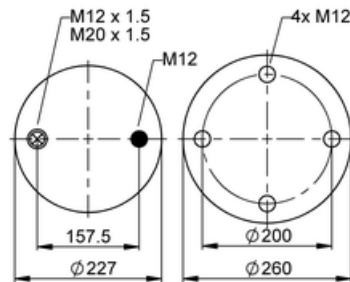
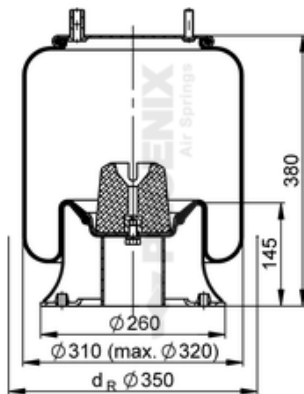

72695

9,7 kg

SMB M001472

K015

M12 = 70 Nm
M20x1,5 = 80 Nm

1 DK 23 K-9082



4 054389 107344

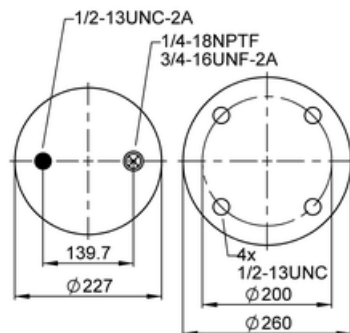
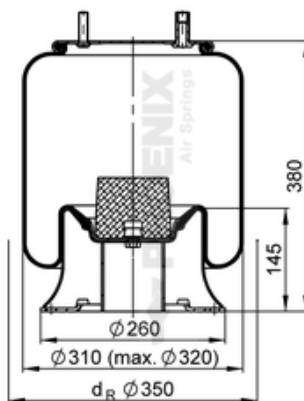

71525

9,8 kg

Neway 905 570 27
Neway 905 570 06
Hendrickson B 2066
Neway 905 570 75
Meritor 2120 8939
Weweler US 09361F
Weweler US 97306
Fruehauf
and more..

G 1/2 = 40 Nm
G 3/4 = 40 Nm

● bolt or stud ○ threaded hole ⊗ combination stud ⊗ air inlet

1 DK 23 L-1



4 054389 112034

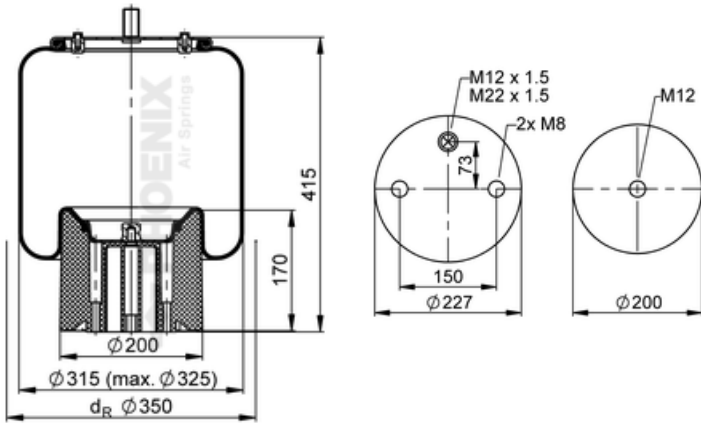

71994

6,1 kg

Schmitz 016 512
Schmitz 124 4666
Schmitz S016512
Schmitz 016 558
Weweler US 06318F
Weweler US 86318F

K037

M8 = 30 Nm
M12 = 40 Nm
M22x1,5 = 40 Nm



1 DK 23 L-1 NP



4 054389 127403

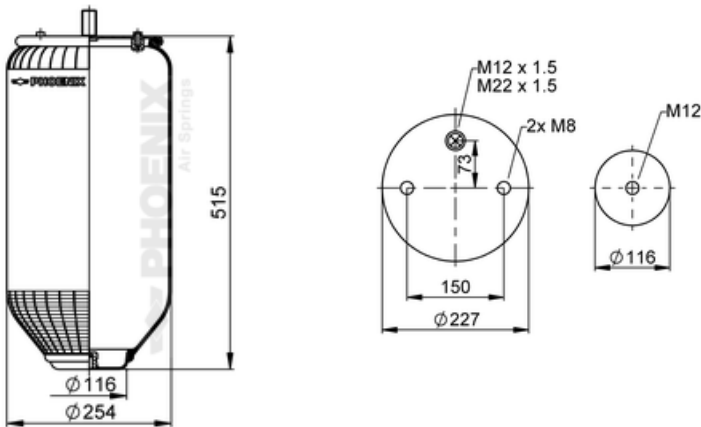

77490

4,1 kg

SA for L-1, L-2

Schmitz

K037

1 DK 23 L-2



4 054389 129728

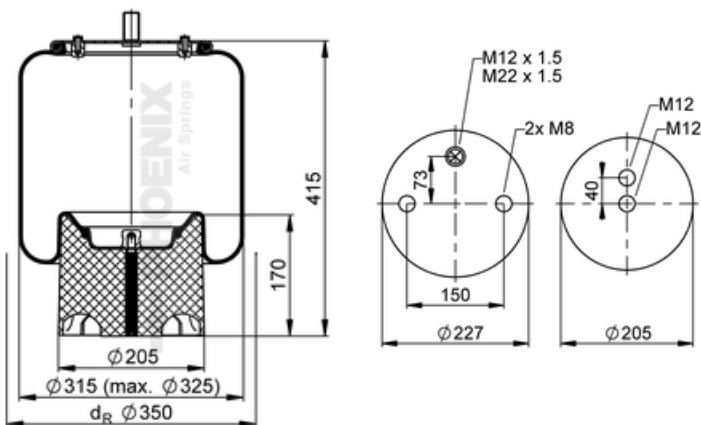

78691

6,2 kg

Schmitz 127 0603
Schmitz 127 4268
Schmitz 137 1342
Schmitz 137 5396
Weweler YP06318SF

K037

● bolt or stud ○ threaded hole ⊗ combination stud ⊗ air inlet



1 DK 23 L-25



4 054389 104909

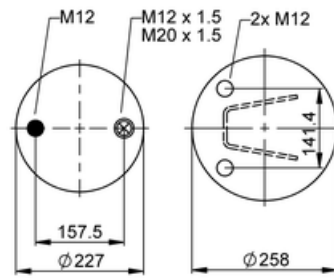
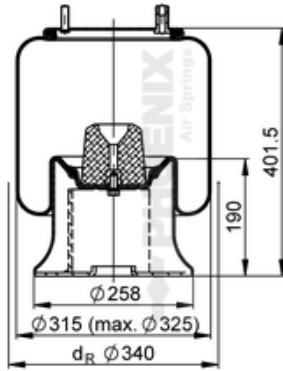

71281

kg 10,8 kg



Fruehauf UJB Q203-001
SMB 1520356
SMB 1518779
SMB 1524873
SMB M001782

kg K030

kg M12 = 70/20 Nm
M20x1,5 = 40 Nm

1 DK 23 L-27



4 054389 105302

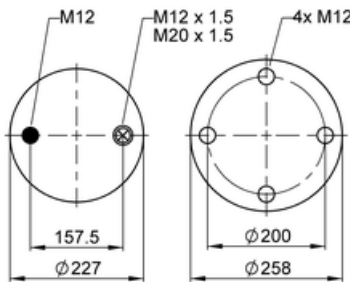
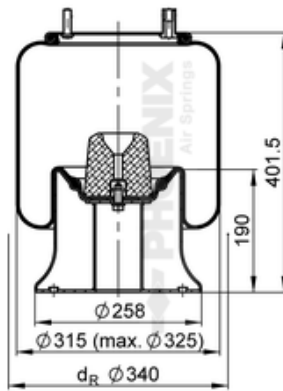

71321

kg 10,5 kg



Fruehauf
SAMRO H2500425
SMB

kg K015

kg M12 = 70 Nm
M20x1,5 = 40 Nm

1 DK 23 L-31



4 054389 119422

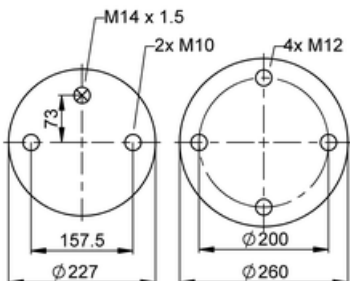
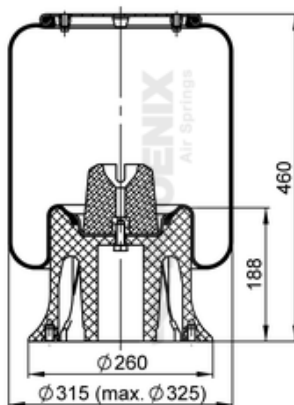

73015

kg 7,2 kg



Scania 1865753
Scania 1314905

● bolt or stud ○ threaded hole ⊗ combination stud ⊗ air inlet

1 DK 23 L-9131



4 054389 104640

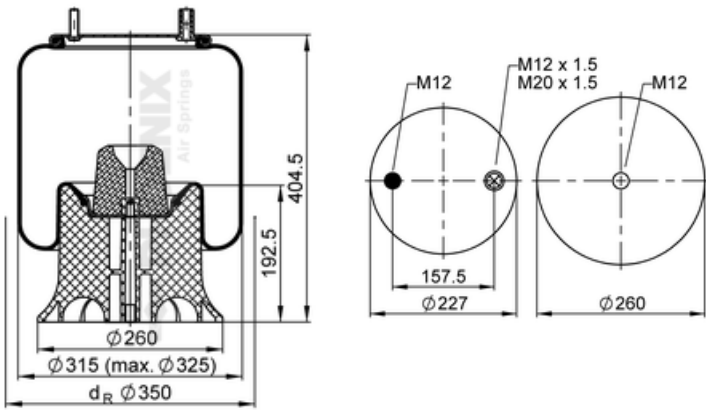

71255

kg 7,6 kg



Fruehauf UJB 0358-001
SAMRO H2500324
SMB 1525199
SMB M001774
Cardi 58051210

K016

M12 = 70 Nm
M20x1,5 = 40 Nm



1 DK 25-1



4 054389 114014

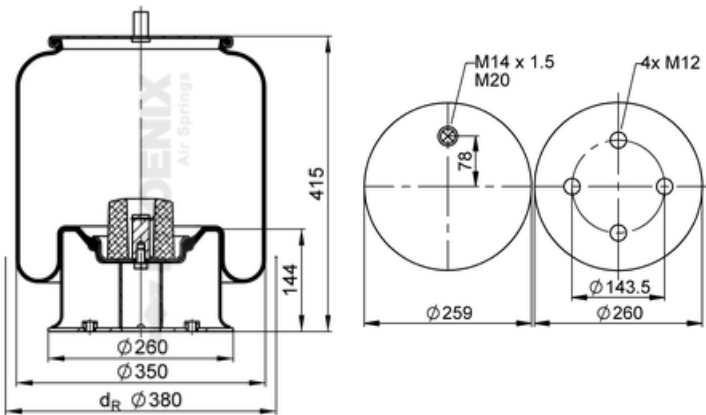

72192

kg 10,5 kg



Daimler TAS A 946 328 04 01
Hendrickson HS 251087
SAMRO H2500915

K027

M12x1,5= 40 Nm
M20x1,5 = 80 Nm

1 DK 28 B-7



4 054389 105661

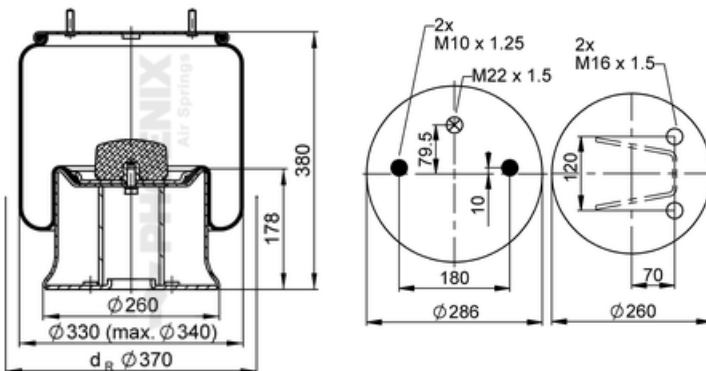

71357

kg 14,1 kg



Bartoletti 91619011
Bartoletti 91619005
Cardi 58051000
Cardi 58050700
Cardi 58050710
Viberti 128147102
Viberti 128147117
Rolfo 112060
and more..

M10x1,25 = 40 Nm
M16x1,5 = 50 Nm
M22x1,5 = 20 Nm

● bolt or stud ○ threaded hole ⊗ combination stud ⊗ air inlet



1 DK 28 D-3



4 054389 112058

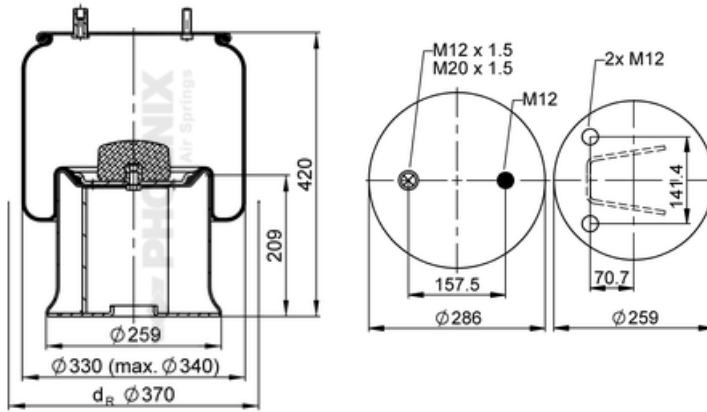

71996

17 kg



Fruehauf UJB 0305
SMB M588762
SMB M001464
Zorzi 1006552

M12 = 70 Nm
M20x1,5 = 40 Nm

1 DK 28 F-3



4 054389 109843

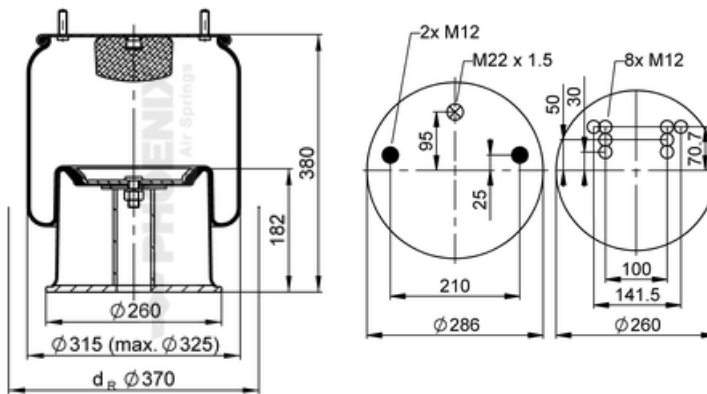

71775

14,6 kg



Daimler TAS A 946 328 15 01
Schmitz 134 4510
Schmitz FAG041-0087
Schmitz 017 924
Schmitz 128 8087
Weweler US 04030F
SMB 093770001
Jost JAE 20 105 015 01
and more...

K011

M12 = 70 Nm
M22x1,5 = 20 Nm

1 DK 28 F-4



4 054389 109027

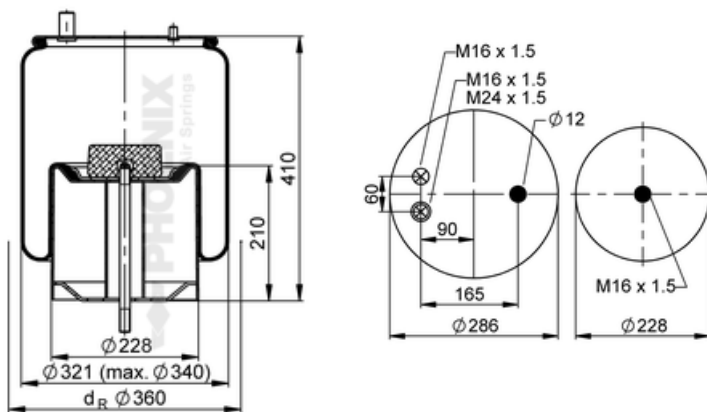

71693

13,1 kg



Renault 5.010.294.307

K018

M16x1,5 = 30/80 Nm
M24x1,5 = 40 Nm

● bolt or stud ○ threaded hole ⊗ combination stud ⊗ air inlet

1 DK 28 F-5



4 054389 116667

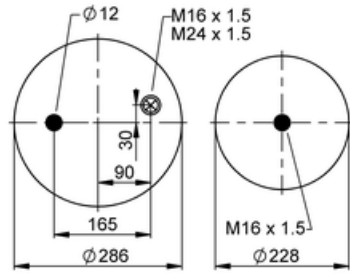
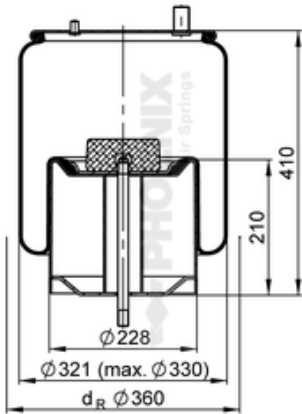

72457

kg 12 kg



Renault 5 010 557 355
Volvo 20 722 412

K018



1 DK 28 F-6



4 054389 123801

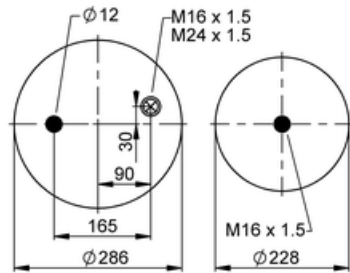
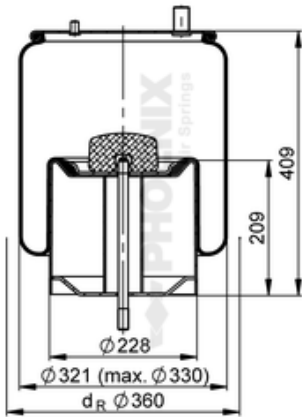

74901

kg 12,6 kg



Renault 21 978 494
Renault 5 010 600 328
Volvo 21 978 504
Volvo 20 726 768
Volvo 25 372 795

K018

1 DK 28 H-3



4 054389 129193

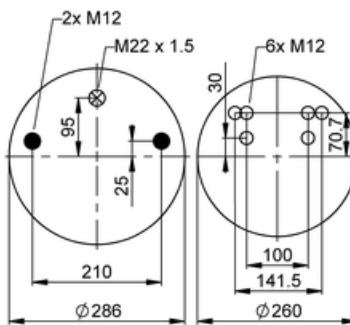
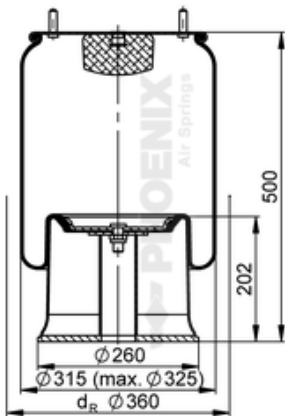

78324

kg 14,4 kg



Daimler TAS 946 328 22 01
Daimler TAS A 946 328 22 01
Jost JAE 30 105 022 01
Jost JAS 30 105 022 01
Jost 30 105 022 01

K011

● bolt or stud ○ threaded hole ⊗ combination stud ⊗ air inlet



1 DK 32



4 054389 109324

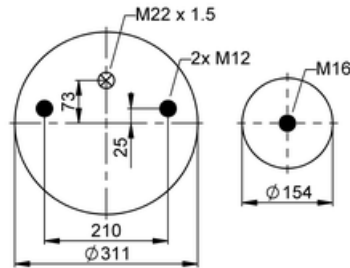
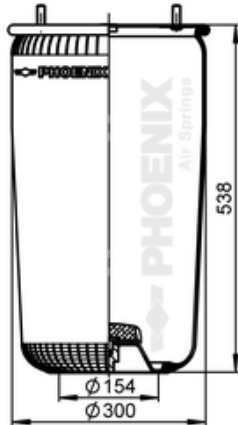

71723

kg 7,3 kg

i SA for 1 DK 32-1,2

BPW BPW 05.429.40.01.0
Schmitz 750 228
Scania Scania 2338883

K029

M12 = 70 Nm
M16 = 130 Nm
M22x1,5 = 20 Nm

1 DK 32 E-4



4 054389 105579

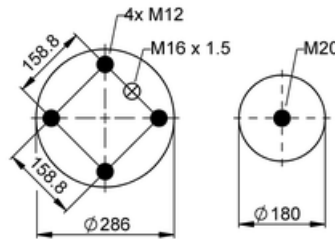
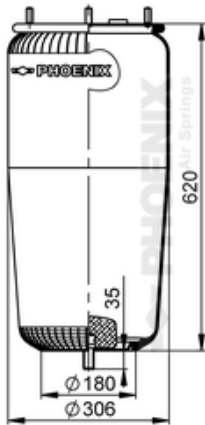

71348

kg 7,3 kg

i service assembly

Kässbohrer 4.731.043.000

K019

M12 = 70 Nm
M16x1,5 = 30 Nm
M20x1,5 = 80 Nm

1 DK 32 K



4 054389 109331

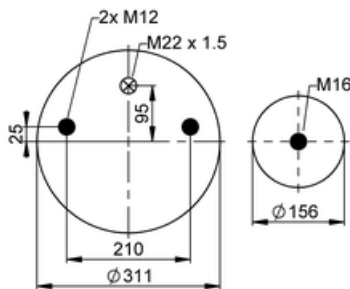
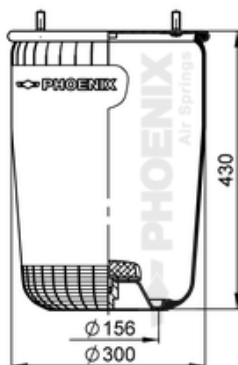

71724

kg 6,2 kg

i SA for K-1, K-2

BPW BPW 05.429.41.01.0
Schmitz 750 570

K029

M12 = 70 Nm
M16 = 130 Nm
M22x1,5 = 20 Nm

● bolt or stud ○ threaded hole ⊗ combination stud ⊗ air inlet

1 DK 32 K-1



4 054389 111426

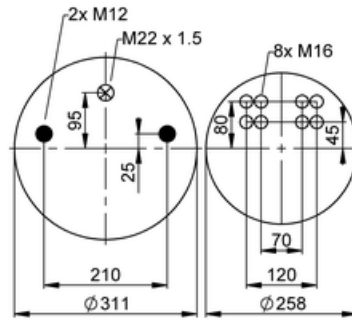
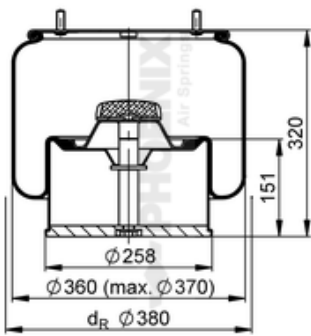

71933

kg 16,7 kg



BPW 05.429.41.31.1
Weweler US 04881R

K029

M12 = 70 Nm
M16 = 70 Nm
M22x1,5 = 20 Nm



1 DK 32 K-2



4 054389 115387

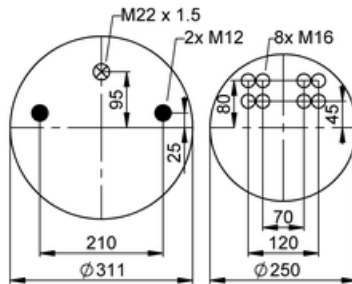
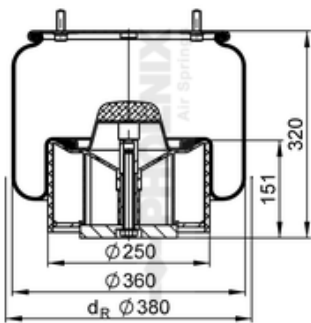

72329

kg 12,6 kg



BPW 05.429.43.41.0
BPW 05.429.43.44.0
Hüffermann 6-AB8003-0200
Scania 2198331

K029

M12 = 70 Nm
M16 = 70 Nm
M22x1,5 = 20 Nm

1 DK 32 L



4 054389 109362

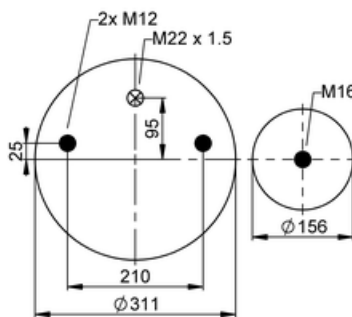
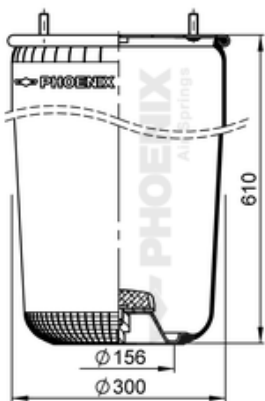

71727

kg 7 kg

SA for 1 DK 32 L-1

BPW 05.429.40.05.0
Schmitz 017 199

K029

M12 = 70 Nm
M16 = 130 Nm
M22x1,5 = 20 Nm

● bolt or stud ○ threaded hole ⊗ combination stud ⊗ air inlet



1 DK 32 L-1



4 054389 119101

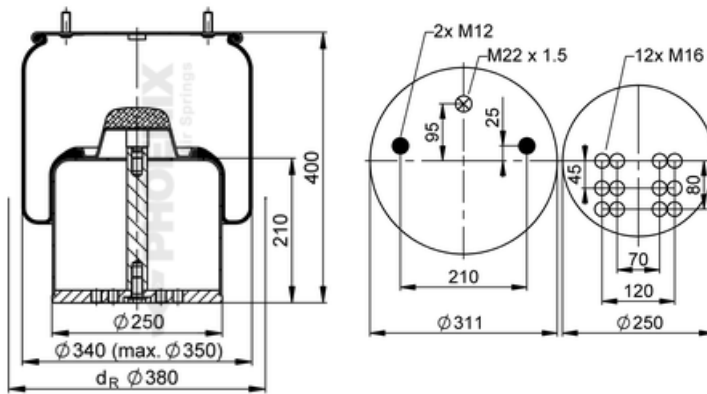

72792

kg 17,4



BPW 05.429.41.69.0
Hüffermann 6-AB8003-0300

kg K029

1 DK 32-1



4 054389 111419

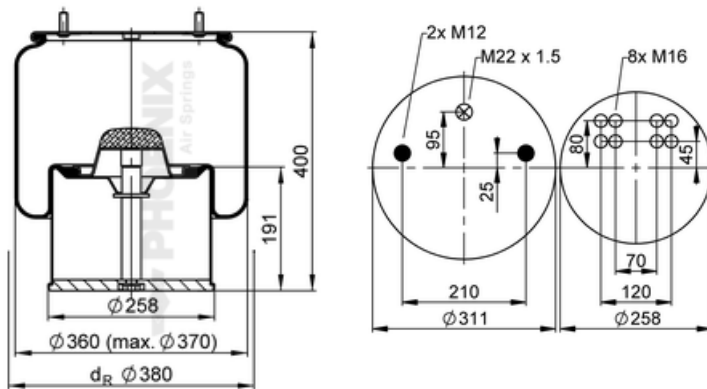

71932

kg 18,1



BPW 05.429.41.36.1

kg K029

kg M12 = 70 Nm
M16 = 70 Nm
M22x1,5 = 20 Nm

1 DK 32-2



4 054389 115370

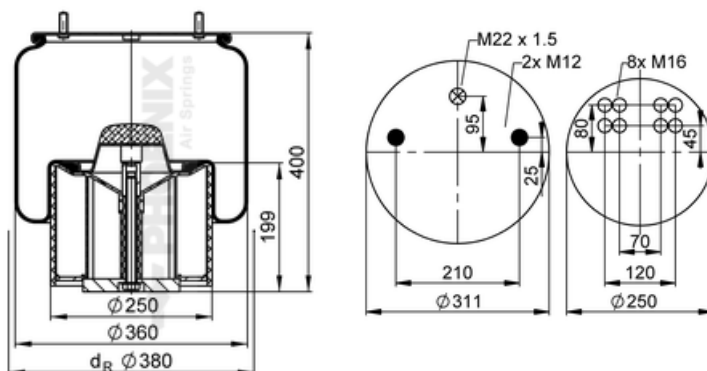

72328

kg 16,8



BPW 05.429.43.51.0
Schmitz 750 496
Schmitz 751 549
Hüffermann 6-AB8003-0100
Scania 2198330

kg K029

kg M12 = 70 Nm
M16 = 70 Nm
M22x1,5 = 20 Nm

● bolt or stud ○ threaded hole ⊗ combination stud ⊗ air inlet

1 E 10 C

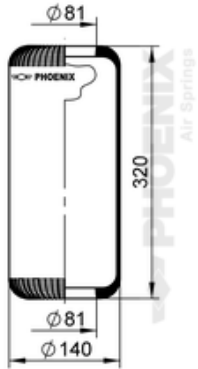

70581



0,9 kg



Optare R5800068
Optare R5800001
ZF Sachs 0501 312 548



1 E 14

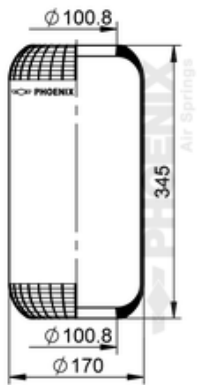

71305



1 kg



IVECO Bus 93166129
Pegaso 93166129

1 E 16

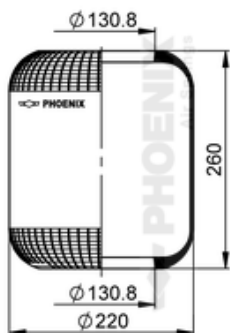

71283



1,2 kg



Autosan
Jelcz
Roman SA



1 E 16-1

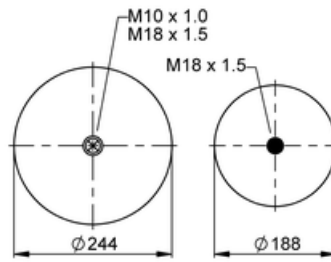
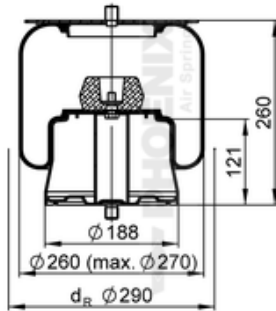

71250

6,1 kg



Autosan
Jelcz
Roman SA 89436016005

M18x1,5 = 80 Nm

1 E 18

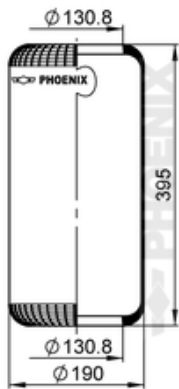

71284

1,3 kg

IRISBUS 5.000.786.640
IRISBUS 5.000.805.284
Heuliez 5.000.805.284
Van Hool 624319-860
Daewoo 96708574

Hyundai
Scania

1 E 18 C

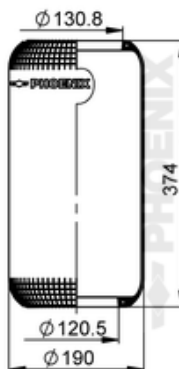

74417

1,6 kg

Volvo 21 836 531
Volvo 21 347 075

● bolt or stud ○ threaded hole ⊗ combination stud ⊗ air inlet

1 E 18 D

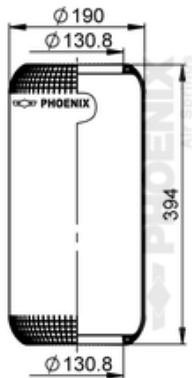

72141

1,6 kg

Volvo 20 535 875



1 E 18 D-01

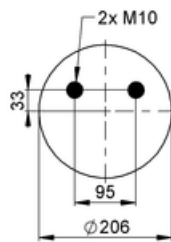
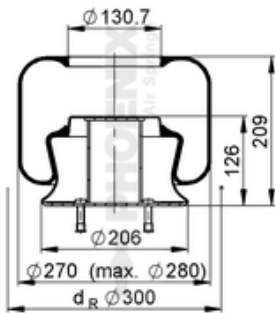

72142

5,1 kg

Volvo 20 535 876

M10 = 40 Nm

1 E 18 D-02

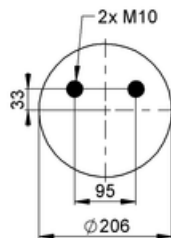
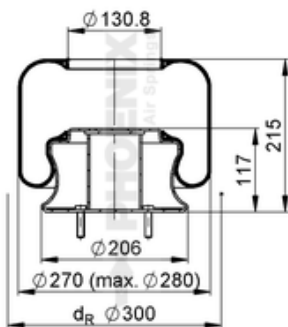

72143

4,4 kg

Volvo 20 535 877

M10 = 40 Nm

● bolt or stud ○ threaded hole ⊗ combination stud ⊗ air inlet



1 E 18 D-03

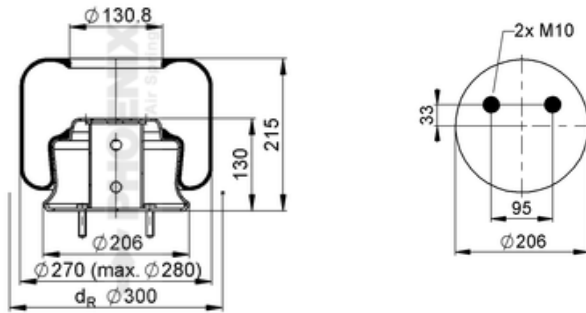

76229

kg 5,3 kg



Volvo 20 725 459

1 E 18 E

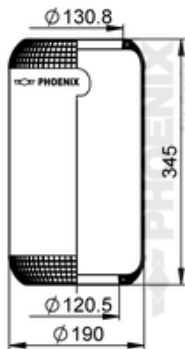

72339

kg 1,5 kg

Volvo 20 540 792

1 E 21

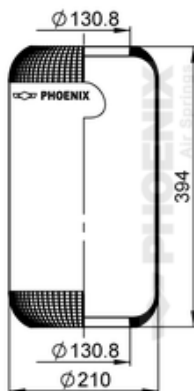

72100

kg 1,7 kg



EvoBus A 000 327 01 01
EvoBus A 327 327 00 01
EvoBus A 327 328 00 01
BredaMenarini 199 196
Kässbohrer 4.771.143.000
Neoplan 1001 10 300
Van Hool 624319-420
Volvo 1 134 445
and more...

● bolt or stud ○ threaded hole ⊗ combination stud ⊗ air inlet

1 E 21 B



4 054389 115493

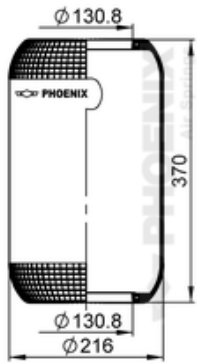

72340



1,5 kg



Volvo 20 540 789



1 E 21 C



4 054389 106378

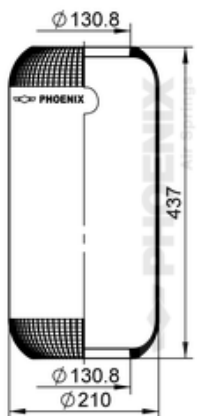

71428



1,9 kg



BredaMenarini 178 741
Kässbohrer
Pegaso 4716989
Pegaso 197145
Pegaso 769388



Hyundai
Scania
IVECO 4716989
and more..

1 E 21 D



4 054389 107276

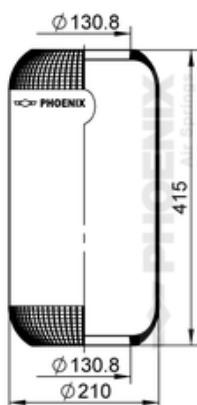

71518



1,6 kg



IRISBUS 500.324.098
IRISBUS 5.000.954.176
IVECO Bus 5003 24098
Daewoo
Hyundai



1 E 21 E

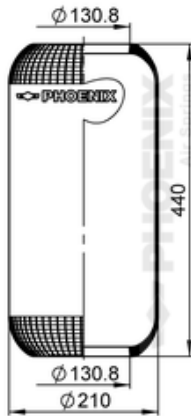

71290

1.7 kg

IVECO 5003 64686

1 E 21 F

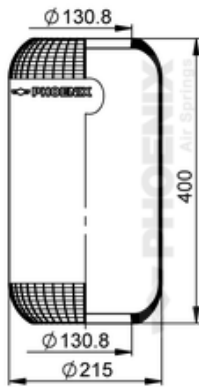

74418

1.7 kg

Volvo 21 836 533

1 E 21-6



71421

1.6 kg

IVECO Bus 4714025
 IVECO Bus 4722525
 IVECO Bus 5254025
 IVECO Bus 6657150
 IVECO 8188526
 IVECO 4738008
 Inbus 484 0005
 Portesi 700 176
 and more...

● bolt or stud ○ threaded hole ⊗ combination stud ⊗ air inlet

1 E 23

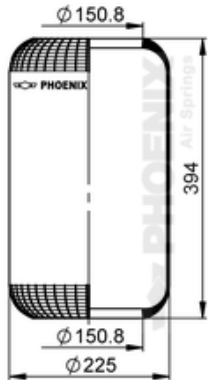

71381

1,8 kg

- EvoBus A 356 327 00 01
- EvoBus A 356 327 02 01
- MB Tuerk A 613 327 01 01
- MB Tuerk A 356 327 00 01
- IVECO Bus 93197594



1 E 23 A

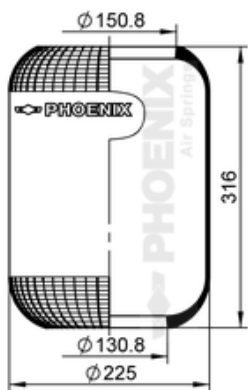

72499

1,8 kg

-
- IRISBUS 5.001.021.414
- IVECO Bus 299729
- IVECO Bus 503130506

1 E 23 A-1

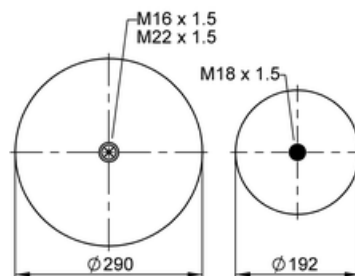
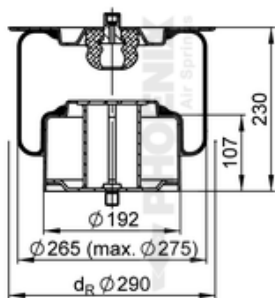

72501

7,8 kg

-
- IRISBUS 5.006.172.377
- K022

● bolt or stud ○ threaded hole ⊗ combination stud ⊗ air inlet



1 E 23 B



72500

1,6 kg



IRISBUS 503.129.220

1 E 23 B-1

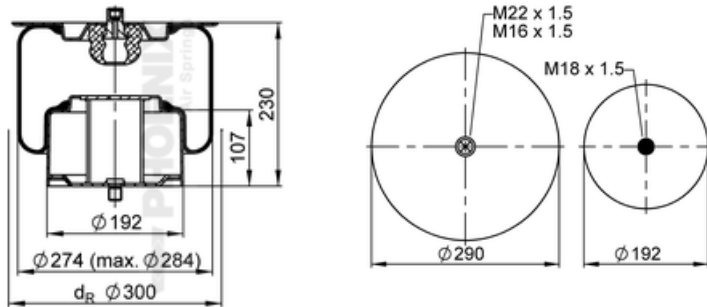

72502

7,5 kg



IRISBUS 504.097.615
IVECO Bus 504097615
IVECO Bus 2997885

K022

1 E 25

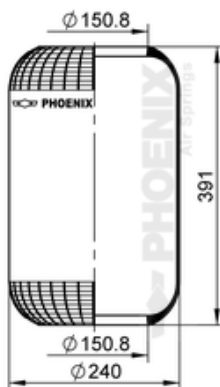

72101

2 kg



EvoBus A 410 327 00 01
IRISBUS 5.001.829.866
IVECO Bus 41822247
Kässbohrer 4.771.440.000
MAN 90.83112.0144
Neoplan AA 10-01-001
 IVECO 4746733
Volvo 1 137 888
and more...

● bolt or stud ○ threaded hole ⊗ combination stud ⊗ air inlet

1 E 25 A

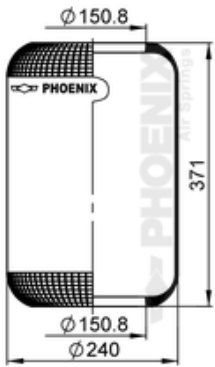

72466

kg 1,6 kg



Bus Heuliez 503 130 261
IRISBUS 503.130.261



1 E 25 B

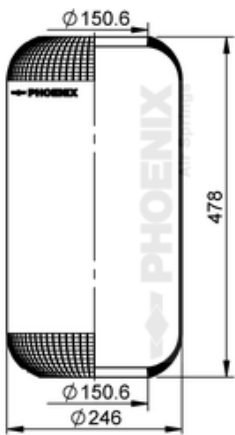

77388

kg 2,1 kg

Truck MAN 81.43601.0163
Sachs 00 1748 451 100

1 E 25-5

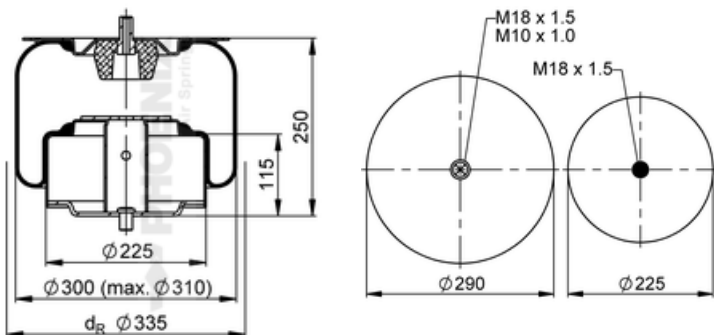

75338

kg 8,9 kg



Bus ZF Sachs 0501 209 513
ZF Sachs 0501 215 443

● bolt or stud ○ threaded hole ⊗ combination stud ⊗ air inlet



1 E 25-9

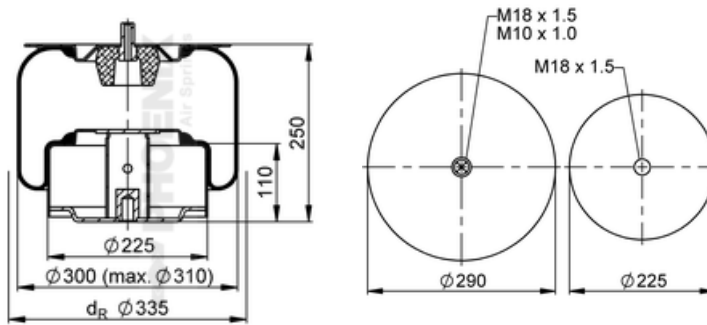

75339

kg 8,5 kg



ZF Sachs 0501 217 174
ZF Sachs 0501 215 602

1 E 26

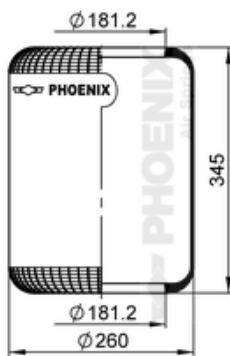

71277

kg 1,7 kg

Bova B 510040
Ikarus B 510040

1 E 26 A

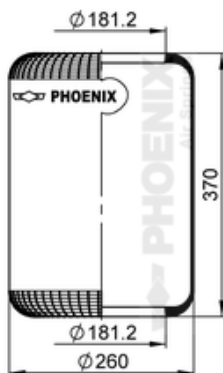

71260

kg 1,8 kg

ZF Sachs 0501 323 798
Bova B 234908
Ikarus
LIAZ

● bolt or stud ○ threaded hole ⊗ combination stud ⊗ air inlet

1 E 26 A-01



4 054389 105272

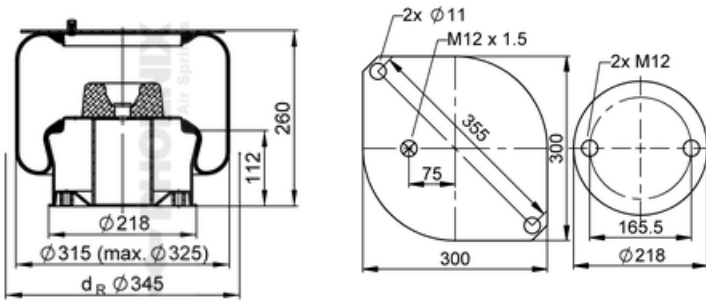

71318

kg 8,9



Bus Den Oudsten 443014
Ikarus

Wrench M12 = 40 Nm



1 E 26 A-13



4 054389 112065

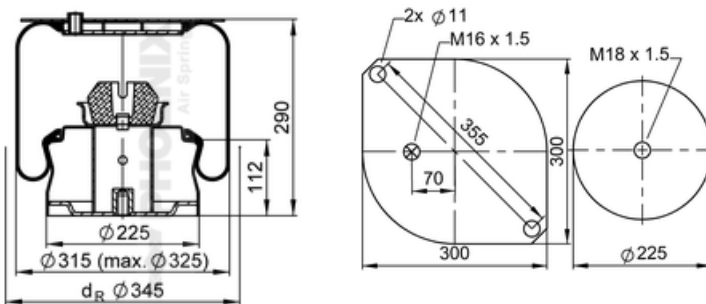

71997

kg 11,1



Bus Bova B 252556

Wrench M16x1,5 = 50 Nm
M18x1,5 = 80 Nm

1 E 26 A-14



4 054389 124372

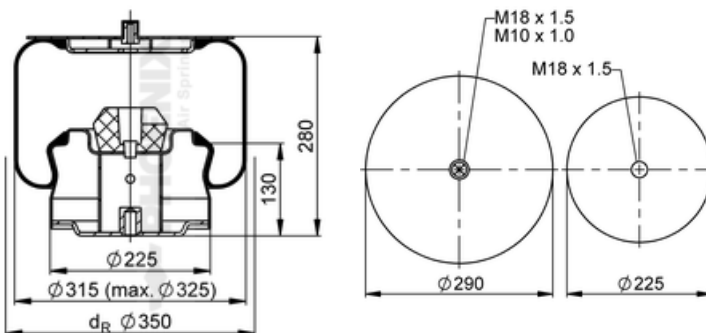

75340

kg 10,8

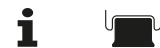

Bus ZF Sachs 0501 215 444
ZF Sachs 0501 215 603

● bolt or stud ○ threaded hole ⊗ combination stud ⊗ air inlet



1 E 26-1

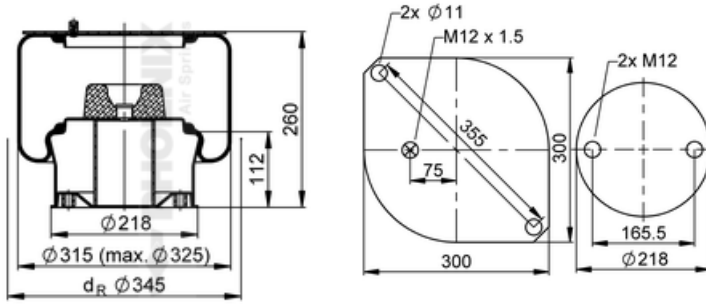

71249

kg 8,8 kg



Bova B 186053
Den Oudsten 450406

K017

M10 = 35 Nm
M12 = 40 Nm

1 E 26-3

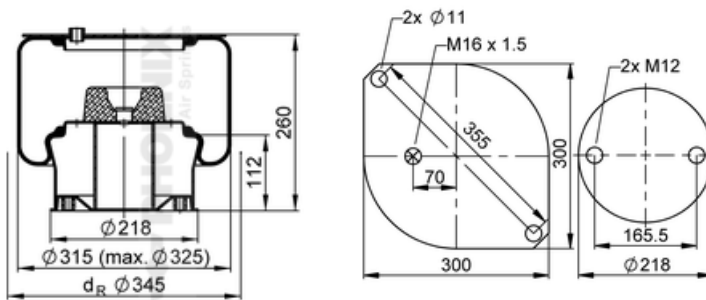

72697

kg 8,7 kg

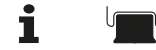

Bova B 235216

1 E 32

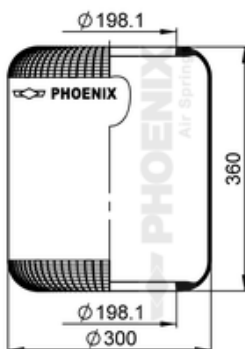

71356

kg 2,5 kg

Neoplan AA 10-01-002
MAN 81.43601.0018
MAN 81.43601.0051
 Neoplan AA 10-21-300
Neoplan 1001 12 251
VDL Bus 0 578 361
 Kögel
Schmitz 750 209
and more...

● bolt or stud ○ threaded hole ⊗ combination stud ⊗ air inlet

1 F 16



4 054389 106316

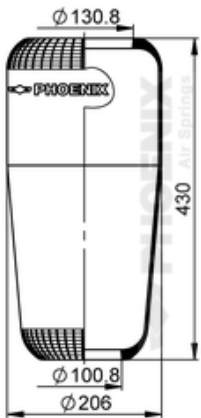

71422



1.7 kg



MAN 81.43601.0065
MAN 81.43601.0067
MAN 81.43601.0070
MAN 81.43601.0092
MAN 81.43601.0099
MAN 81.43601.0103
MAN 81.43601.0121
MAN 81.43601.0132
and more...



1 F 20 A



4 054389 106392

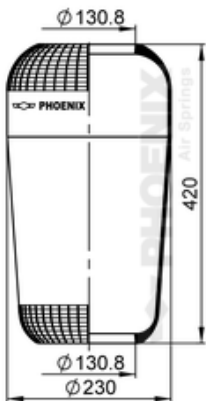

71430



1.7 kg



IRISBUS 5.000.301.452
IVECO Bus 5003 01452
IVECO Bus 97108363
Pegaso 8188539



IVECO 8188539



MAN 81.43601.0106



MAN 81.43601.0108

MAN 81.43601.0069

and more...

1 F 20 B



4 054389 105746

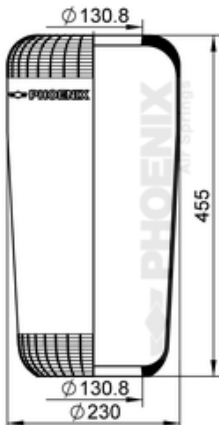

71365



2 kg



MAN 81.43601.0104
MAN 81.43601.0109
MAN 81.43601.0111
MAN 81.43601.0123
MAN 81.43601.0125
MAN 81.43601.0140
MAN 81.43601.0150
IVECO 98478799
and more...



1 F 20 C



4 054389 119095

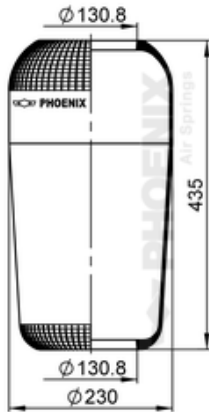

72791

1,7 kg

EvoBus A 628 323 00 92

1 F 20 C-1



4 054389 133114

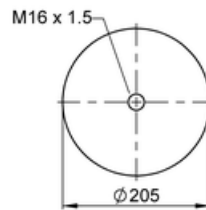
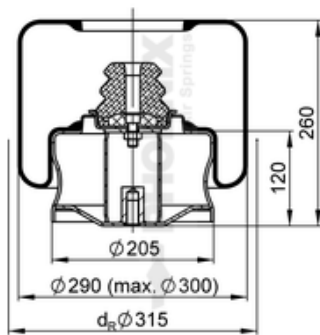

600756

6,4 kg



EvoBus A 628 320 08 25

1 F 20 C-2



4 054389 133121

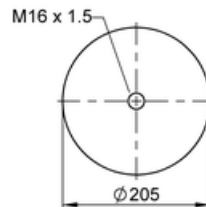
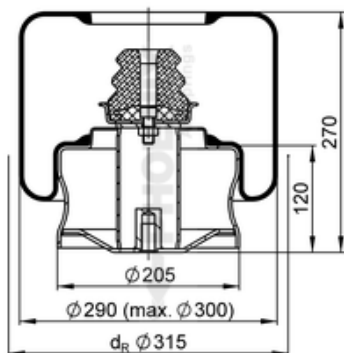

600757

6,4 kg



EvoBus A 628 320 09 25

● bolt or stud ○ threaded hole ⊗ combination stud ⊗ air inlet

1 F 20 C-3

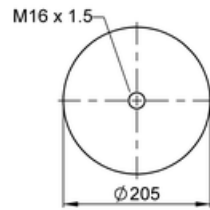
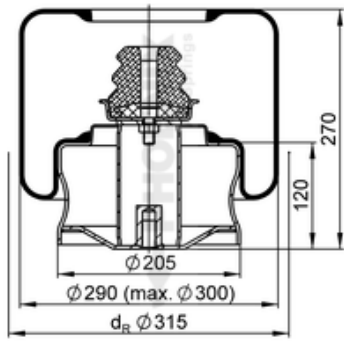

600758

6,5 kg



EvoBus A 628 320 10 25



1 F 20 C-4

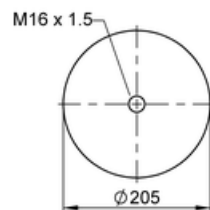
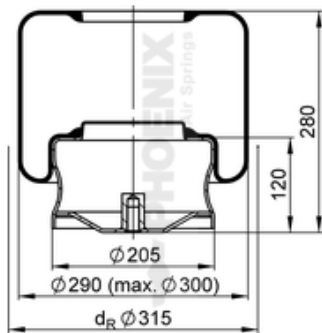

600759

5,1 kg



EvoBus A 628 320 12 25

1 F 21



71355

2,1 kg

MAN 81.43601.0036
MAN 81.43601.0037
Mercedes A 387 328 01 01
Volvo 1 629 193
MAN 81.43601.0033
 Neoplan 1001 12 300
Pegaso
Volvo 1 590 136
and more...



1 F 21 A



4 054389 105852

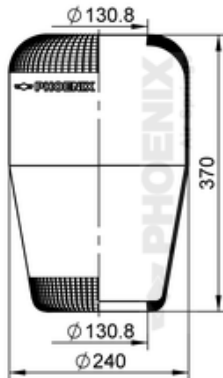

71376



1,6 kg



Mercedes A 383 327 00 01
Volvo 1 611 776



Magirus-Deutz 0249 1566
EvoBus A 383 327 00 01
EvoBus A 621 328 00 01
BredaMenarini 178 623
BredaMenarini 325 993
VDL Bus 0 627 584
and more...

1 F 21 C-2



4 054389 105890

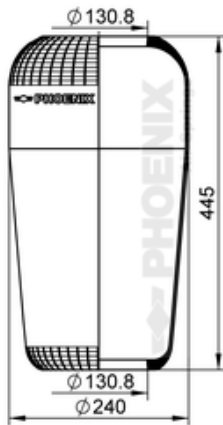

71380



2,1 kg



MAN 81.43601.0071
MAN 81.43601.0072
MAN 81.43601.0110
MAN 81.43601.0128
MAN 81.43601.0137



Volvo 1 082 085
Pegaso

1 F 21 C-5



4 054389 105883

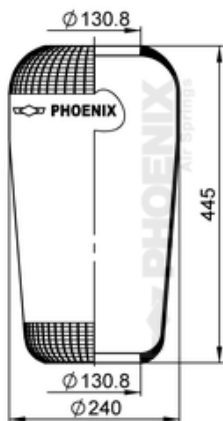

71379



2,1 kg



gekrepelt Zeichen 72848



MAN 81.43601.0095
MAN 81.43601.0097
MAN 81.43601.0100
MAN 81.43601.0102
MAN 81.43601.0105
MAN 81.43601.0126
MAN 81.43601.0138
Optare L5820005
and more...

● bolt or stud ○ threaded hole ⊗ combination stud ⊗ air inlet

1 F 21 D

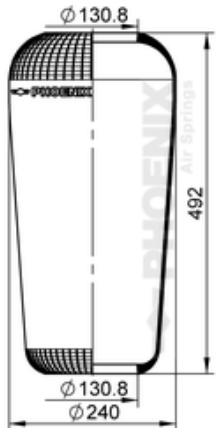

71768

kg 2,2 kg

Truck Volvo 6 797 169
Volvo 1 622 116
Volvo 6 797 169



1 F 26

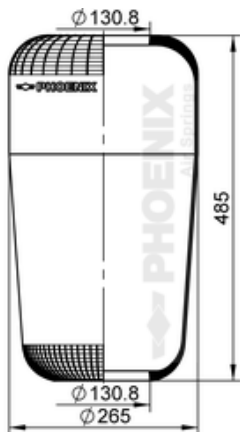

71423

kg 2,4 kg

Truck Mercedes A 393 328 01 01
Mercedes 393 328 01 01

1 F 26 B-1



71425

kg 2,1 kg

Truck MAN 81.43601.0039
MAN 81.43601.0040
Volvo 1 593 842

● bolt or stud ○ threaded hole ⊗ combination stud ⊗ air inlet



1 F 26 C



71426

1,9 kg

Mercedes A 363 328 02 01
Mercedes 363 328 02 01

1 F 26 D

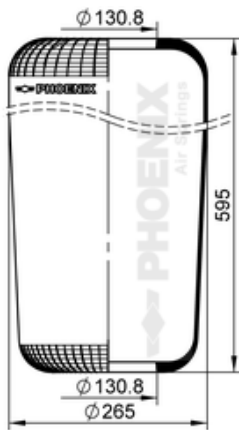

71424

2,9 kg

Mercedes A 674 328 00 01
Mercedes 674 328 00 01

1 F 32 A

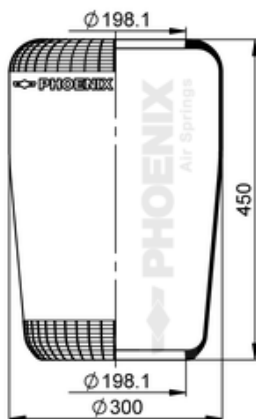

71458

2,8 kg

MAN 81.43601.0116
MAN 81.43601.0091
MAN 81.43601.0079
MAN 81.43601.0082
MAN 81.43601.0084
MAN 81.43601.0114
 MAN 81.43601.0057
MAN 81.43601.0056
and more...

● bolt or stud ○ threaded hole ⊗ combination stud ⊗ air inlet

1 F 32 B



4 054389 106385

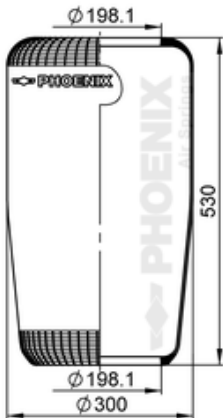

71429



3,1 kg



DAF 0 818 225
BPW 02.200.24.00.0
Gigant 166205
Gigant 196036
Kässbohrer 4.731.032.000
Schmitz 750 215



SMB
Neoplan 1001 10 100
and more...



1 KF 21-1



4 054389 107405

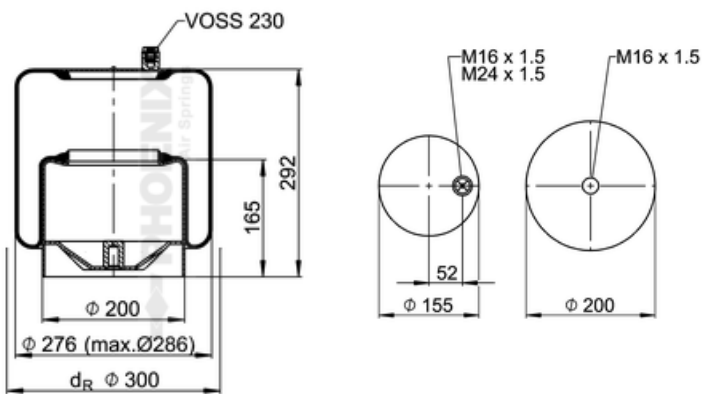

71531



6,8 kg



Mercedes A 942 320 01 21
Mercedes 942 320 01 21



K021



M16x1,5 = 130 Nm
M24x1,5 = 100 Nm

1 KF 21-1 NP



4 054389 107429

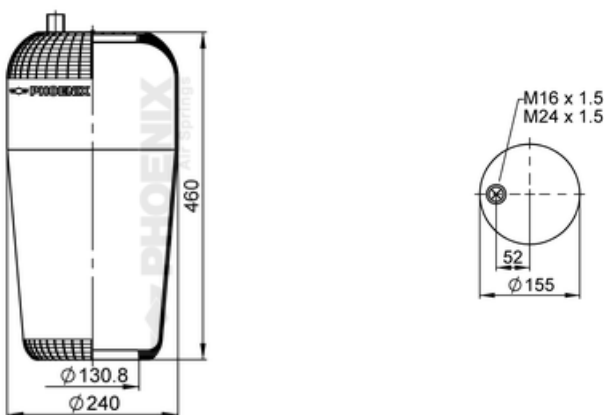

71533



2,8 kg



SA for 21-1, 21-21



Mercedes A 942 328 00 01
Mercedes 942 328 00 01



K021



M24x1,5 = 100 Nm

● bolt or stud ○ threaded hole ⊗ combination stud ⊗ air inlet



1 KF 21-2

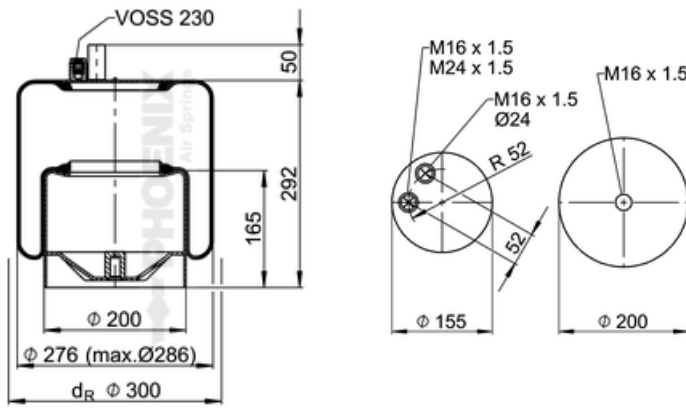

71532

kg 7,1 kg



Mercedes A 942 320 02 21
Mercedes 942 320 02 21

K021

M16x1,5 = 130 Nm
M24x1,5 = 100 Nm

1 KF 21-2 NP

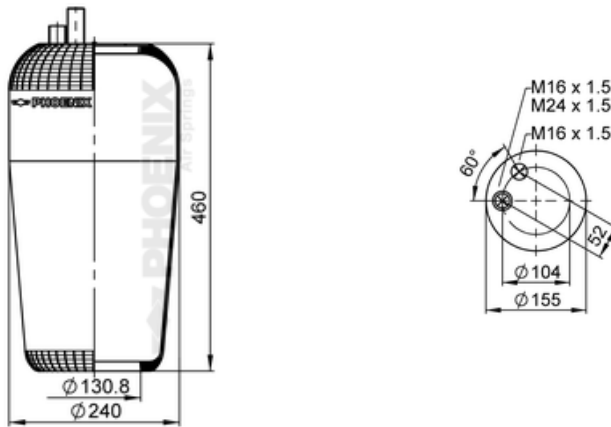

71534

kg 2,9 kg

SA for 21-2, 21-22

Mercedes A 942 328 01 01
Mercedes 942 328 01 01

K021

M24x1,5 = 100 Nm

1 KF 21-21

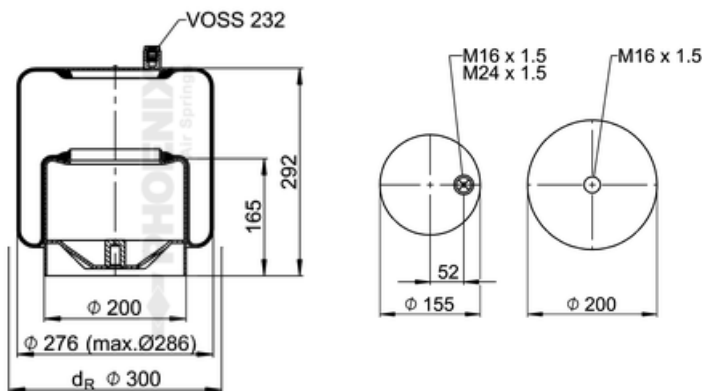

71998

kg 6,9 kg



Mercedes A 942 320 28 21
Mercedes A 942 320 49 21
Mercedes 942 320 28 21
Mercedes 942 320 49 21

K021

M16x1,5 = 130 Nm
M24x1,5 = 100 Nm

● bolt or stud ○ threaded hole ⊗ combination stud ⊗ air inlet

1 KF 21-22



4 054389 112089

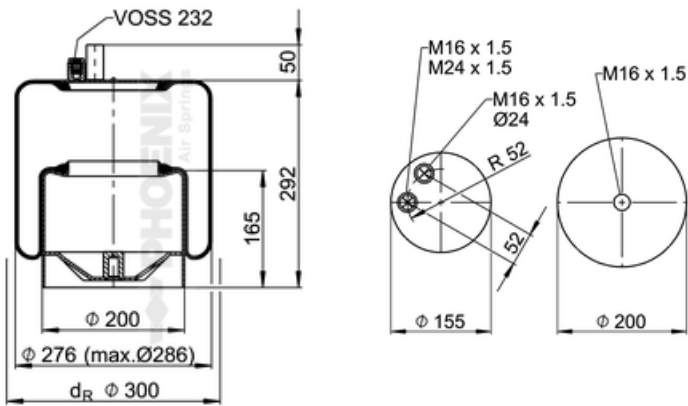

71999

kg 7,1 kg



Truck Mercedes A 942 320 29 21
Mercedes A 942 320 50 21
Mercedes 942 320 29 21
Mercedes 942 320 50 21

Spring K021

Wrench M16x1,5 = 130 Nm
M24x1,5 = 100 Nm



1 KF 24-1



4 054389 117879

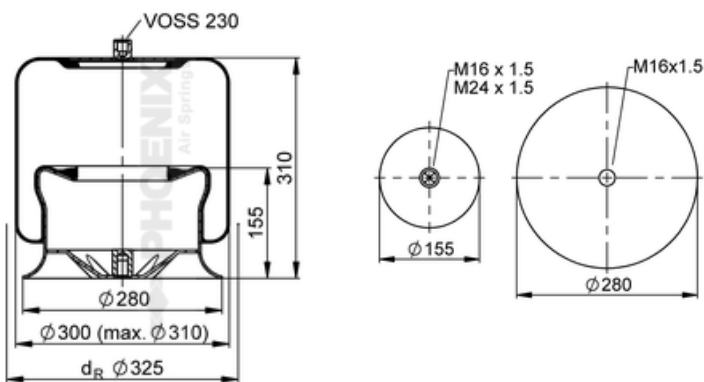

72578

kg 7,4 kg



Truck Mercedes A 942 320 01 17
Mercedes 942 320 01 17

Spring K021

1 KF 24-1 NP



4 054389 118234

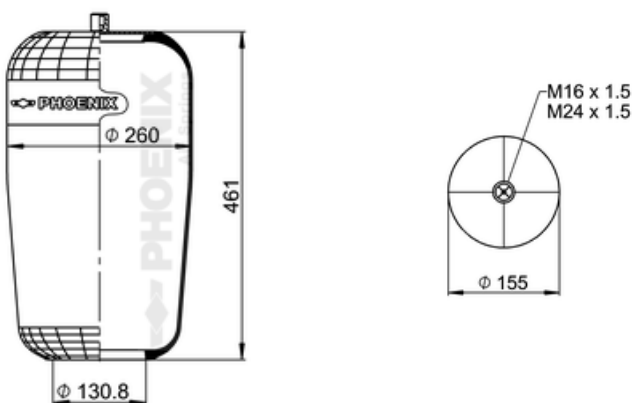

72614

kg 2,5 kg

i SA for 24-1, 24-21

Truck Mercedes A 942 327 00 01
Mercedes 942 327 00 01

Spring K021

● bolt or stud ○ threaded hole ⊗ combination stud ⊗ air inlet



1 KF 24-2 NP



4 054389 118241

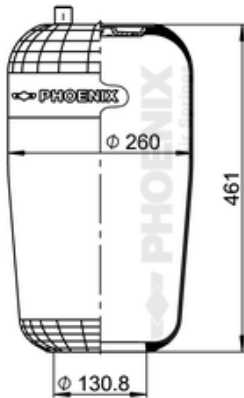

72615

3 kg

SA for 24-9, 24-29

Mercedes A 974 328 00 01
Mercedes A 974 328 01 01
Mercedes 974 328 00 01
Mercedes 974 328 01 01

K021

1 KF 24-21



4 054389 118258

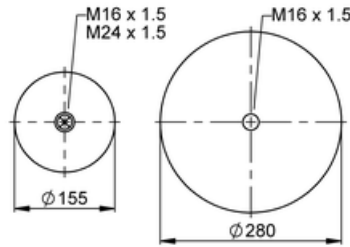
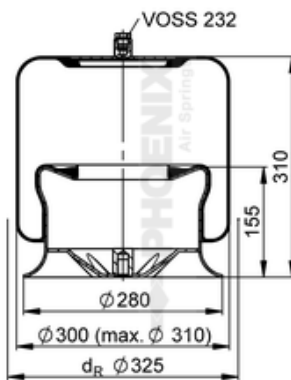

72616

7.4 kg

Mercedes A 942 320 43 21
Mercedes 942 320 43 21

K021

1 KF 24-29



4 054389 118265

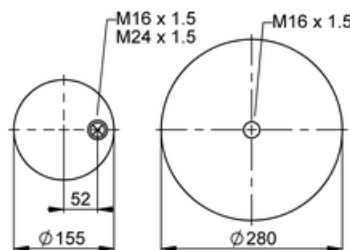
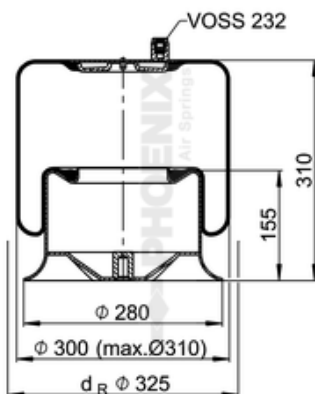

72617

8 kg

Mercedes A 942 320 32 21
Mercedes 942 320 32 21

K021

● bolt or stud ○ threaded hole ⊗ combination stud ⊗ air inlet

1 KF 24-9



4 054389 117862

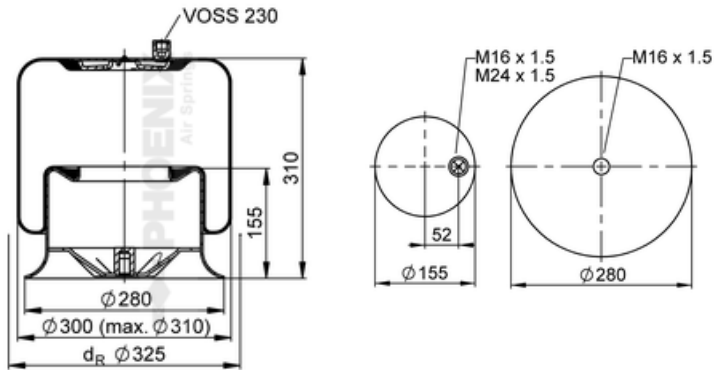

72577

kg 8 kg

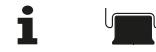

i Mercedes A 974 320 02 17
Mercedes A 974 320 04 17
Mercedes 974 320 02 17
Mercedes 974 320 04 17

K021



1 KF 32-23



4 054389 119743

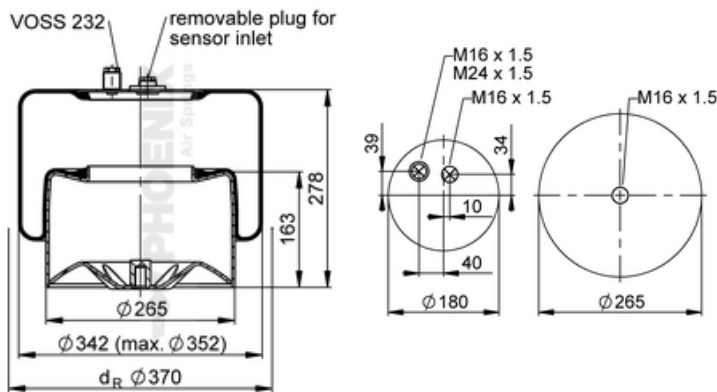

73175

kg 9,3 kg



i Mercedes A 942 320 13 21
Mercedes A 942 320 14 21
Mercedes A 942 320 22 21
Mercedes A 942 320 23 21
Mercedes 942 320 13 21
Mercedes 942 320 14 21
Mercedes 942 320 22 21
Mercedes 942 320 23 21
and more..

K021

1 KF 32-23 NP



4 054389 119736

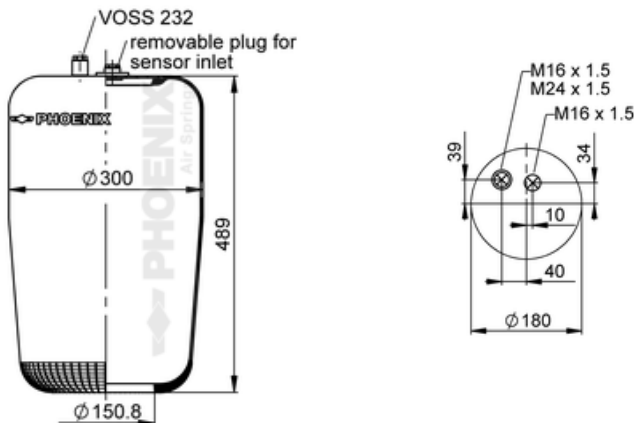

73173

kg 3,2 kg

i service assembly for 1 KF 32-23

K021

● bolt or stud ○ threaded hole ⊗ combination stud ⊗ air inlet



2 B 07 R



4 054389 106644

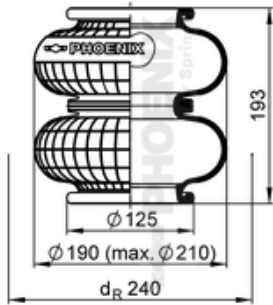

71455



0,8 kg

2 B 12 R



4 054389 104671

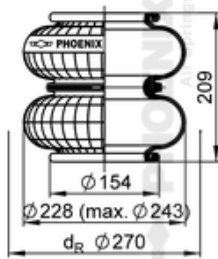

71258



1,2 kg



Volvo 6 882 797
Volvo 0 365 431
Volvo 0 365 461

2 B 20 R



4 054389 104978

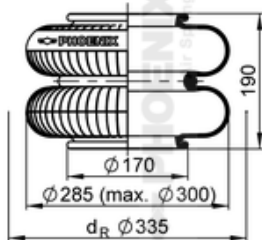

71288



1,7 kg



BPW 02.200.20.50.0
Kässbohrer 4.731.024.000
Kässbohrer 4.731.003.000



MAN 88.96420.0217



Granning 15923



Magirus-Deutz 0342 2571

● bolt or stud ○ threaded hole ⊗ combination stud ⊗ air inlet

2 B 20 R-9



4 054389 106590

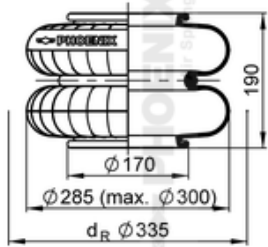

71450



2,2 kg



Kässbohrer 4.731.036.000



2 B 34 R



4 054389 106651

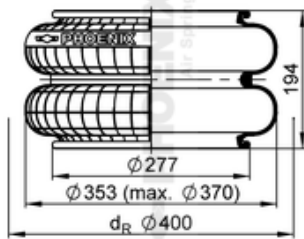

71456



2,7 kg



Kässbohrer 4.731.005.000

2 B 34 R-B



4 054389 106668

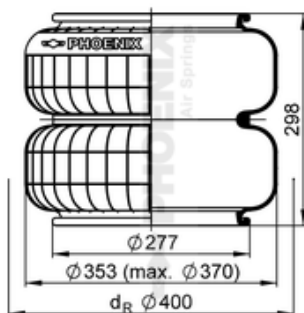

71457



3,3 kg



Kässbohrer 4.731.034.100
Kässbohrer 4.731.034.200



2 B 49 R-A



4 054389 104947

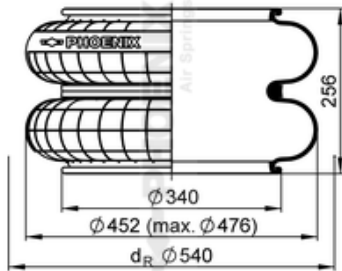

71285

kg 3,8 kg

Kässbohrer 4.731.035.100
Kässbohrer 4.731.035.200

2 B 49 R-B



4 054389 104954

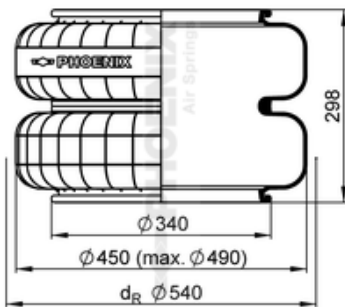

71286

kg 3,9 kg

Kässbohrer 4.731.025.000
 Volvo 1 593 700

2 C 91-10



4 054387 135677

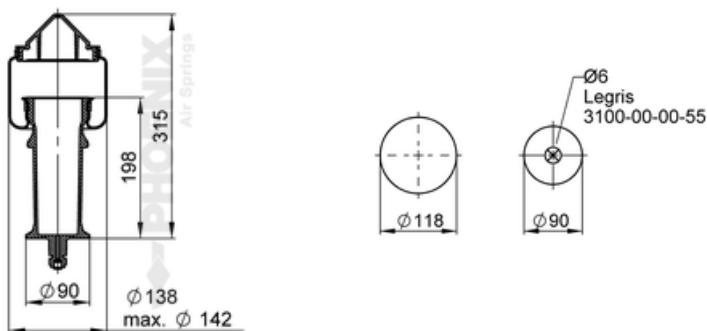

69426

kg 0,9 kg



Renault 5.010.491.301

● bolt or stud ○ threaded hole ⊗ combination stud ⊗ air inlet

2 E 18 A

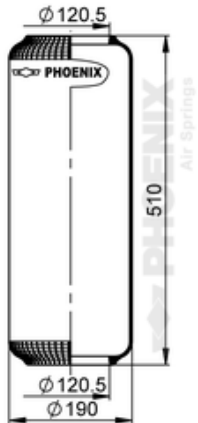

71268

kg 1,9 kg

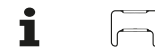

Scania 411627
Dennis 655 606/1
Dennis 656 300/2



2 E 18 B

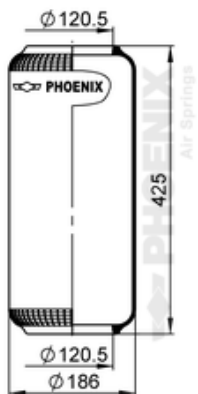

71270

kg 1,5 kg



Volvo Leyland 3 116 354
Volvo 3 116 354
Dennis 611 896/12
Volvo Leyland AAU 2542
Jonckheere

2 E 23

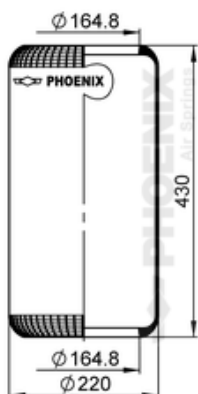

71269

kg 1,9 kg



Scania 411622
Scania 411623
Pegaso 794686
Pegaso 795097
Dennis 656 289/2

Cardif 58050315
 Dennis 656 298/2
LAG
and more...



2 E 23 A



4 054389 105289

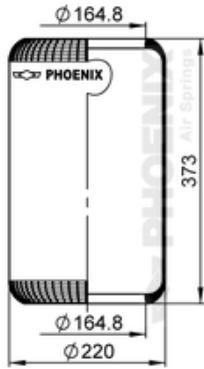

71319

1,7 kg



Dennis 650 292/8
Dennis 650 883/4
Dennis 650 883/7
Volvo Leyland 3 116 983
Volvo 3 116 983
Volvo Leyland 10 904 403
Volvo Leyland AAU 2544
IVECO Bus 6453741
and more...

2 F 18



4 054389 109805

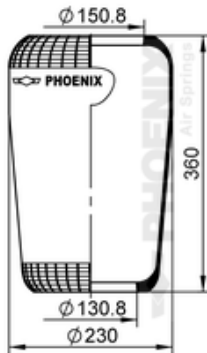

71771

1,5 kg

IRISBUS 5.001.843.640

2 F 18-1



4 054389 109928

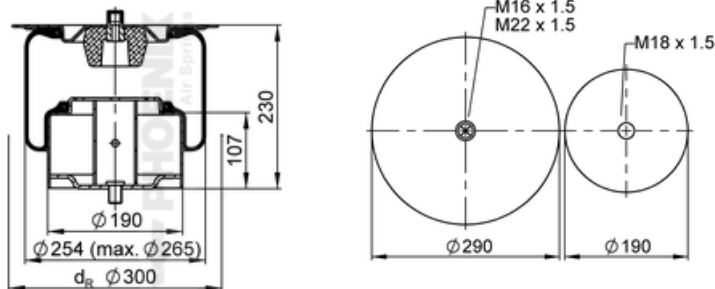

71783

7,7 kg



Heuliez 5 010 531 181
IRISBUS 5.010.531.181

K022

M16x1,5 = 50 Nm
M18x1,5 = 80 Nm
M22x1,5 = 80 Nm

● bolt or stud ○ threaded hole ⊗ combination stud ⊗ air inlet

2 G 20



4 054389 104831

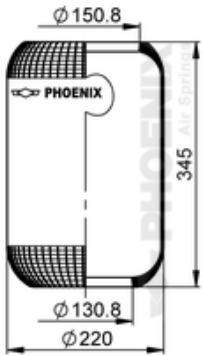

71274



1,4 kg



Volvo 3 027 271



2 G 20 A



4 054389 104848

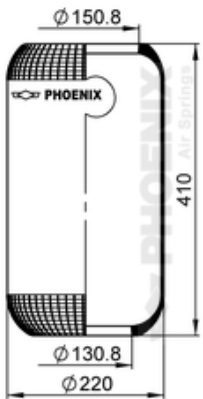

71275



1,6 kg



Volvo 3 027 272

C 075 185



4 054389 112157

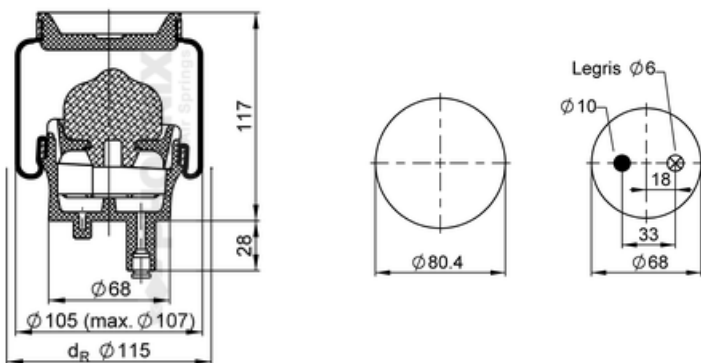

72006



0,5 kg



Renault 5.010.629.414
Renault 5.010.130.797.G
Volvo 20 906 196

● bolt or stud ○ threaded hole ⊗ combination stud ⊗ air inlet



C 100 004

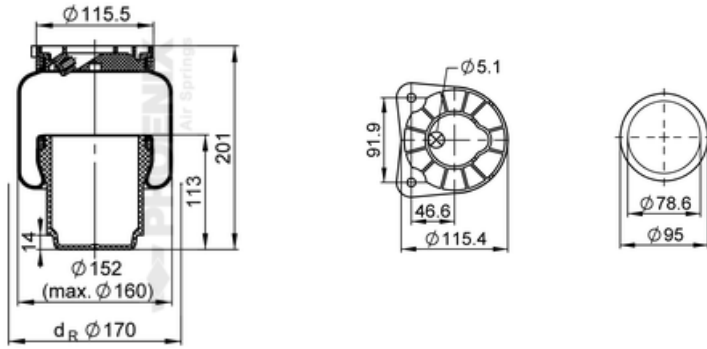

71367

kg 0,8 kg



Mercedes A 638 328 05 01

SP 1 B 04

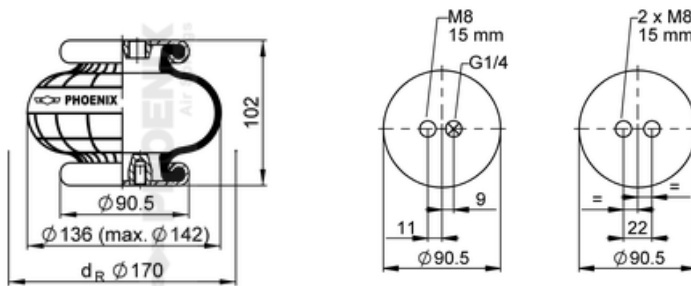

71296

kg 1 kg



M8 = 30 Nm
G 1/4 = 35 Nm

SP 1 B 07

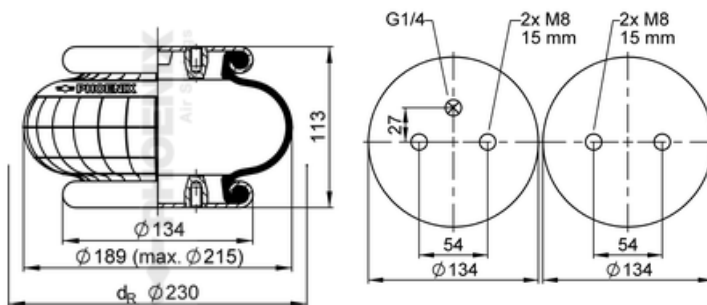

71320

kg 1,7 kg



M8 = 30 Nm
G 1/4 = 35 Nm

● bolt or stud ○ threaded hole ⊗ combination stud ⊗ air inlet

SP 1 B 12-1



71262

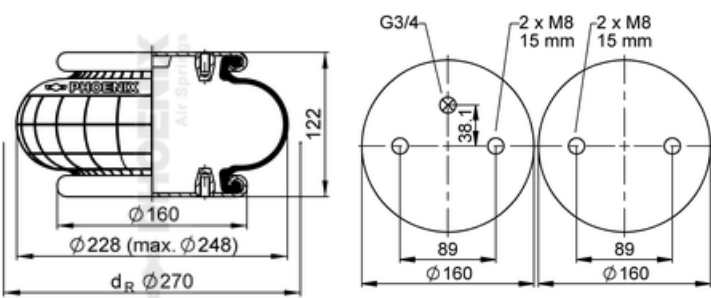

kg 2,4 kg

Wrench M10 = 40 Nm
G 3/4 = 50 Nm

SP 1 B 34



63727

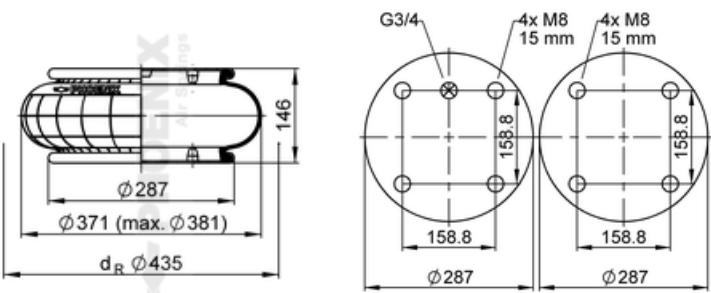

kg 6 kg

Wrench M8 = 30 Nm
G 3/4 = 50 Nm

SP 2 B 07 R



71389

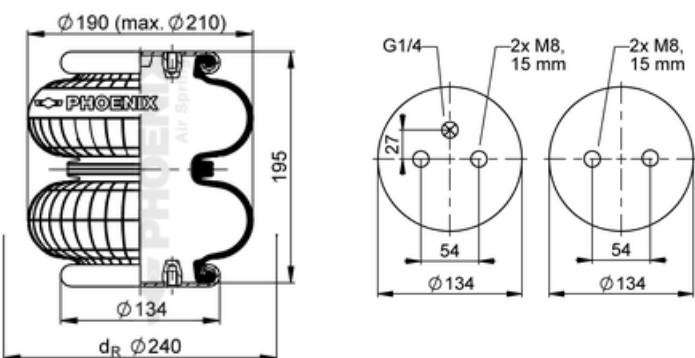

kg 2,1 kg

Wrench M8 = 30 Nm
G 1/4 = 35 Nm

● bolt or stud ○ threaded hole ⊗ combination stud ⊗ air inlet



SP 2 B 12 R



4 054389 104657

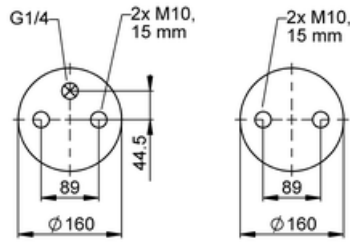
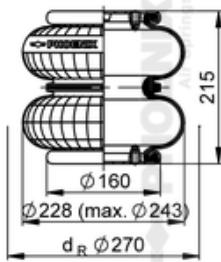

71256

2,9 kg

- Meritor 2122 1395
- Meritor 2122 2663
- Granning 15603
- Granning 1371
- Weweler US 06910
- Floor 13586
- KRONE 550018680

K023

M10 = 35 Nm
G 1/4 = 35 Nm

SP 2 B 12 R-1



4 054389 104725

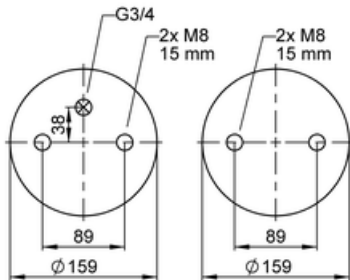
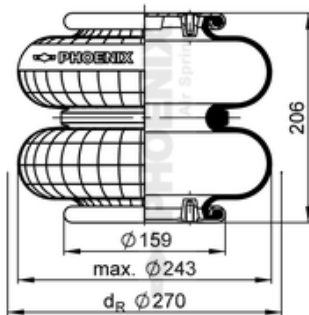

71263

2,9 kg

- Gigant 700190130
- Gigant 00190130
- Gigant 190130

M8 = 30 Nm
G 3/4 = 50 Nm

SP 2 B 12 R-16



4 054389 124105

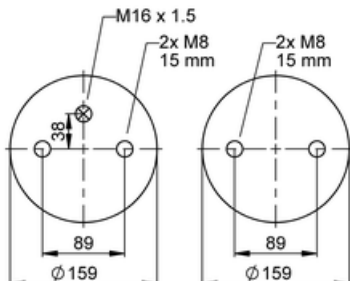
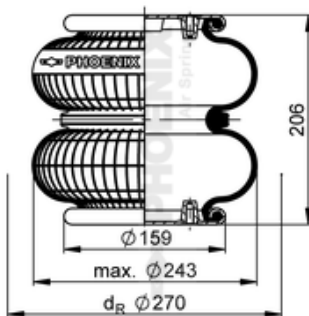

75061

2,9 kg

- KRONE 550018054
- KRONE 550011095
- Gigant 00190130

● bolt or stud ○ threaded hole ⊗ combination stud ⊗ air inlet

SP 2 B 12 R-17



4 054389 127113

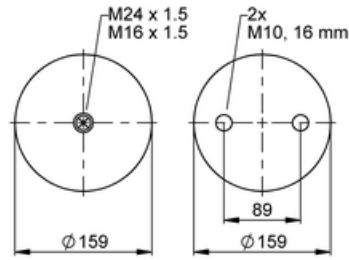
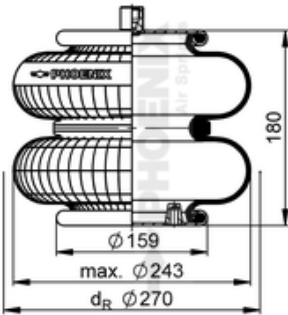

77371

3 kg

Hendrickson HS505613
Mercedes A 942 327 06 01
Mercedes 942 327 06 01



SP 2 B 12 R-5



4 054389 107351

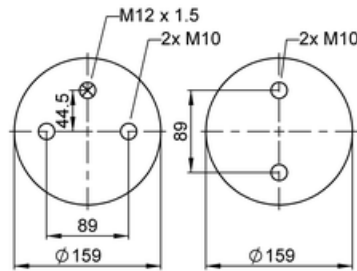
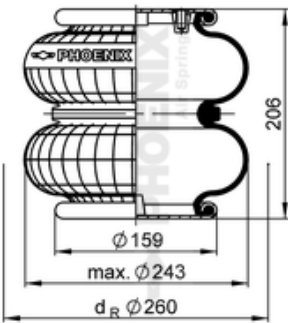

71526

2,8 kg

SAF - Holland 4.229.1004.00
Kögel 6501706
Kögel 6502824
Granning 15599
 Scania 1723523
Scania 1387289
Scania 1319761

K023

M10 = 35 Nm
M12x1,5= 40 Nm

SP 2 B 12 R-A-10



4 054389 110177

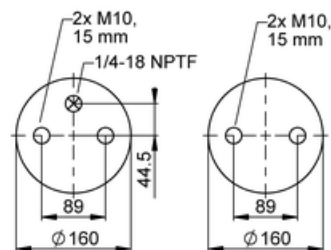
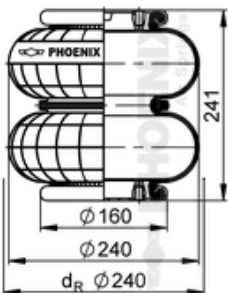

71808

3 kg

Daimler TAS A 946 328 16 01
Weweler US 07394C
Weweler US 07394
Schmitz 016 808
Weweler US 07394F
Meritor 2122 1356
Valx 81005002
Granning 15670
and more..

K023

M10 = 35 Nm
G 1/4 = 35 Nm

● bolt or stud ○ threaded hole ⊗ combination stud ⊗ air inlet



SP 2 B 12 R-A-3

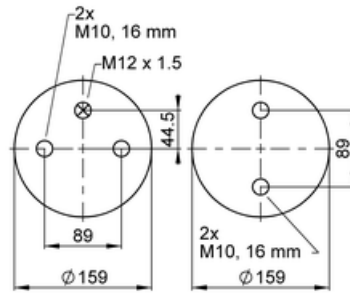
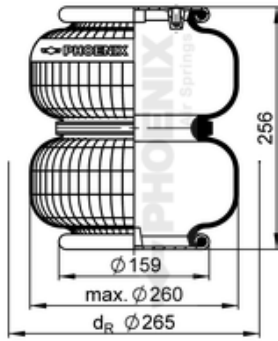

71769

3 kg

SAF - Holland 1608
SAF - Holland 4.229.1005.01
SAF - Holland 4.229.1005.00

M10 = 35 Nm
M12x1,5= 40 Nm

SP 2 B 12 R-A-4

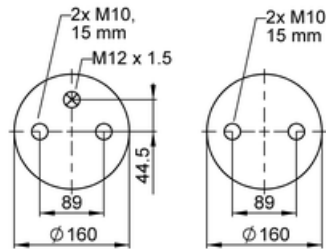
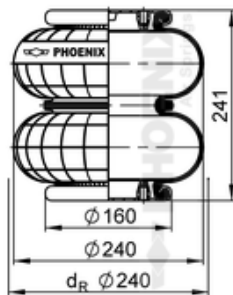

71883

3 kg

Schwarzmüller

M10 = 35 Nm
M12x1,5= 40 Nm

SP 2 B 12 R-B-1

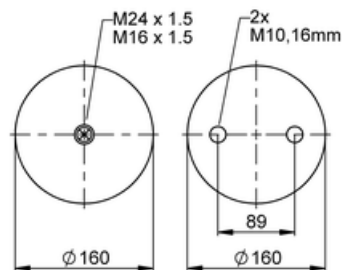
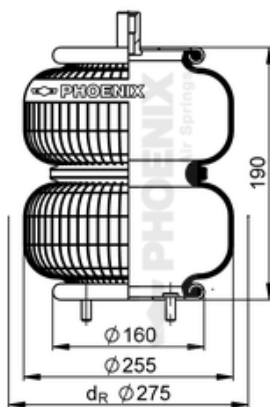

601031

3,1 kg

Volvo 20 541 504
Volvo 22 573 233

● bolt or stud ○ threaded hole ⊗ combination stud ⊗ air inlet

SP 2 B 22 R-1

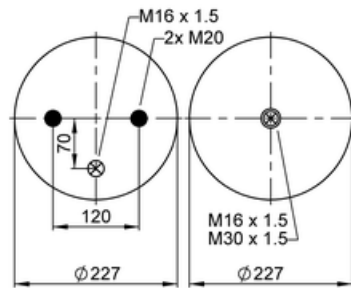
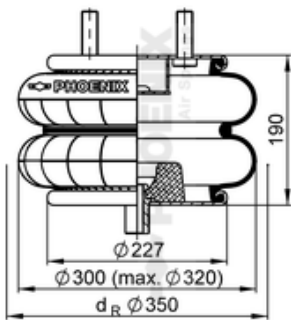

71885

7.2 kg

Kässbohrer 4.731.045.100
Kässbohrer 4.731.045.300

M16x1,5 = 30 Nm
M20x1,5 = 80 Nm
M30x1,5 = 80 Nm



SP 2 B 34 R

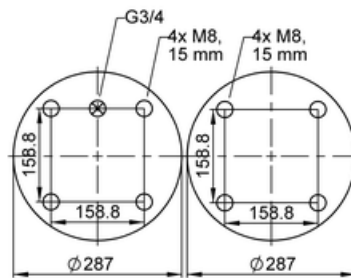
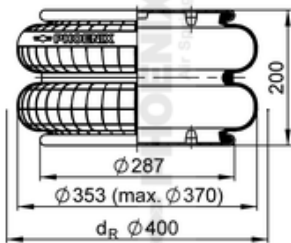

71535

7 kg

Gigant 196071
Gigant 700196071

M8 = 30 Nm
G 3/4 = 50 Nm

SP 2 B 34 R-B

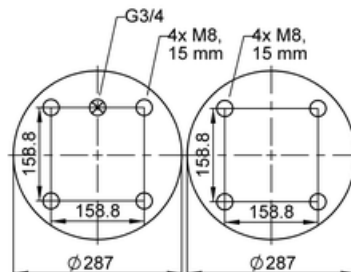
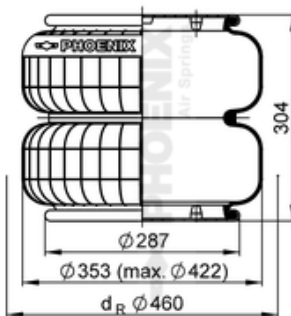

71473

7.7 kg







M8 = 30 Nm
G 3/4 = 50 Nm

● bolt or stud ○ threaded hole ⊗ combination stud ⊗ air inlet



Zuordnungslisten | Fitment guide
Listes de classification | Lista de aplicaciones
Таблицы применяемости | Listy przyporządkowania



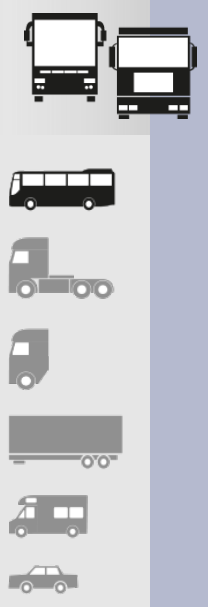

OE	OE #	PHX		  	 
Austral Dening		1 DK 23 H-0742			67
Autosan		1 E 16			77
Autosan		1 E 16-1			78
Bova	B 186053	1 E 26-1			88
Bova	B 234908	1 E 26 A		3	86
Bova	B 235216	1 E 26-3			88
Bova	B 252556	1 E 26 A-13			87
Bova	B 510040	1 E 26	Futura FLD	1,3	86
BredaMenarini		1 D 23 C-1			18
BredaMenarini	178 623	1 F 21 A	201-201/1LU		92
BredaMenarini	178 741	1 E 21 C	110 L		81
BredaMenarini	178 741	1 E 21 C	120-101		81
BredaMenarini	199 196	1 E 21			80
BredaMenarini	325 993	1 F 21 A			92
BredaMenarini	D031115	1 F 16			89
Büssing	100 110 200	1 E 32	L16 / 22		88
Büssing	100 112 251	1 E 32	L16 / 22		88
Büssing	536 905 265	1 E 21	F 76	3	80
Büssing	536 905 266	1 E 21	F 76	3	80
Büssing	546 905 134	1 E 25	F 22152 AL	3	84
Büssing	546 905 134	1 E 25	F 223 LNL	3	84
Büssing	831 120 144	1 E 25	BS 110 GT	3	84
Büssing	831 120 144	1 E 25	BS 120 N	3	84
Büssing	831 120 144	1 E 25	BS 16 / 22	3	84
Büssing	831 120 144	1 E 25	BS 16 L / 22 L	3	84
Büssing	831 120 144	1 E 25	BS 16 S / 22 S	3	84
Daewoo		1 E 21 D			81
Daewoo	96708574	1 E 18			78
Daewoo	96708659	1 E 21			80
Den Oudsten	443014	1 E 26 A-01			87
Den Oudsten	450406	1 E 26-1			88
Dennis	611 896/12	2 E 18 B	Dart	1	103
Dennis	611 896/12	2 E 18 B	Domino	1,3	103
Dennis	611 896/12	2 E 18 B	Dragon	1	103
Dennis	611 896/12	2 E 18 B	Javelin	1,3	103
Dennis	611 896/12	2 E 18 B	Lancet	1,3	103
Dennis	650 292/8	2 E 23 A	Dart	3	104
Dennis	650 292/8	2 E 23 A	Dominator	3	104
Dennis	650 292/8	2 E 23 A	Falcon	3	104
Dennis	650 883/4	2 E 23 A	Integral	1,3	104
Dennis	650 883/7	2 E 23 A	Duple 425	1,3	104
Dennis	655 606/1	2 E 18 A	Dart SLF		103



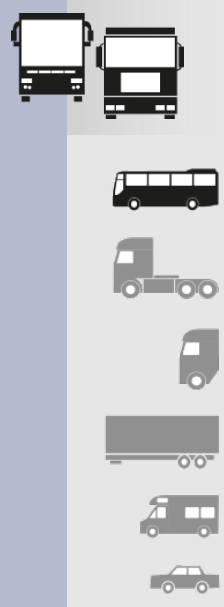





1 Front Axle 2 Mid or Driven Axle
3 Rear or Tag Axle



OE	OE #	PHX			
Dennis	656 289/2	2 E 23	Trident	1,3	103
Dennis	656 298/2	2 E 23			103
Dennis	656 300/2	2 E 18 A	Javelin	3	103
Dennis	656 300/2	2 E 18 A	Trident	2	103
EvoBus	000 327 01 01	1 E 21			80
EvoBus	000 327 02 01	1 E 21			80
EvoBus	307 327 00 01	1 E 21			80
EvoBus	307 328 00 01	1 E 21			80
EvoBus	327 328 00 01	1 E 21			80
EvoBus	383 327 00 01	1 F 21 A			92
EvoBus	621 328 00 01	1 F 21 A			92
EvoBus	A 000 327 01 01	1 E 21	O 302	1,3	80
EvoBus	A 000 327 01 01	1 E 21	O 303	1,3	80
EvoBus	A 000 327 01 01	1 E 21	O 305	1,2,3	80
EvoBus	A 000 327 01 01	1 E 21	O 307	1,3	80
EvoBus	A 000 327 01 01	1 E 21	O 309	1,3	80
EvoBus	A 000 327 01 01	1 E 21	O 317	1,3	80
EvoBus	A 000 327 01 01	1 E 21	O 404	3	80
EvoBus	A 000 327 01 01	1 E 21	O 405	1,3	80
EvoBus	A 000 327 01 01	1 E 21	O 405 G	1,3	80
EvoBus	A 000 327 01 01	1 E 21	O 405 G 2	1	80
EvoBus	A 000 327 01 01	1 E 21	O 405 N	1	80
EvoBus	A 000 327 01 01	1 E 21	O 407	1,3	80
EvoBus	A 000 327 01 01	1 E 21	O 417	1,3	80
EvoBus	A 000 327 01 01	1 E 21	O 580	3	80
EvoBus	A 000 327 01 01	1 E 21	OC 500 CBC	3	80
EvoBus	A 000 327 01 01	1 E 21	OC 500 IBC	2,3	80
EvoBus	A 000 327 01 01	1 E 21	TC 400	3	80
EvoBus	A 000 327 02 01	1 E 21			80
EvoBus	A 000 327 03 01	1 E 21			80
EvoBus	A 307 327 00 01	1 E 21			80
EvoBus	A 307 328 00 01	1 E 21		1,2,3	80
EvoBus	A 307 328 00 01	1 E 21	O 322	1,3	80
EvoBus	A 327 327 00 01	1 E 21		1,2,3	80
EvoBus	A 327 327 01 01	1 E 21		1,2,3	80
EvoBus	A 327 328 00 01	1 E 21	O 321	1,3	80
EvoBus	A 356 327 00 01	1 E 23	O 404	1	83
EvoBus	A 356 327 02 01	1 E 23	O 403 RHD, SHD EURO 2/3	1	83
EvoBus	A 383 327 00 01	1 F 21 A			92
EvoBus	A 410 327 00 01	1 E 25	Tourismo / Travego	3	84
EvoBus	A 621 328 00 01	1 F 21 A			92
EvoBus	A 628 320 08 25	1 F 20 C-1	Setra HDH 415 / 416	1	90



1 Front Axle 2 Mid or Driven Axle
3 Rear or Tag Axle

OE	OE #	PHX		  	 
EvoBus	A 628 320 08 25	1 F 20 C-1	Citaro O530, Travego O580	1	90
EvoBus	A 628 320 09 25	1 F 20 C-2	Setra HDH 415 / 416	2	90
EvoBus	A 628 320 09 25	1 F 20 C-2	Citaro G, GL, articulated	2	90
EvoBus	A 628 320 10 25	1 F 20 C-3	Setra HDH 415 / 416	2,3	91
EvoBus	A 628 320 10 25	1 F 20 C-3	Citaro K, L, G, GL	2,3	91
EvoBus	A 628 320 12 25	1 F 20 C-4	Setra HDH 415 / 416 low	2,3	91
EvoBus	A 628 320 12 25	1 F 20 C-4	Citaro LE, low entry	2,3	91
EvoBus	A 628 323 00 92	1 F 20 C		1,2,3	90
Granning	1371	SP 2 B 12 R			108
Heuliez	5 010 531 181	2 F 18-1			104
Heuliez	5.000.805.284	1 E 18			78
Heuliez	503 130 261	1 E 25 A			85
Hyundai		1 E 18			78
Hyundai		1 E 21 C			81
Hyundai		1 E 21 D			81
Ikarus		1 E 25	19001	1	84
Ikarus		1 E 25	19002	1	84
Ikarus		1 E 25	Vöv - Bus	3	84
Ikarus		1 E 26 A	19001	1	86
Ikarus		1 E 26 A	19002	1	86
Ikarus		1 E 26 A	Vöv - Bus	3	86
Ikarus		1 E 26 A-01			87
Ikarus		1 E 32	19001	1	88
Ikarus		1 E 32	19002	1	88
Ikarus		1 E 32	Vöv - Bus	3	88
Ikarus	B 510040	1 E 26	256, 260, 280	1,3	86
Inbus	484 0005	1 E 21-6		1	82
Inbus	489 0001	1 E 21-6		1	82
IRISBUS	5.000.301.452	1 F 20 A			89
IRISBUS	5.000.786.640	1 E 18	ER/PR 180	3	78
IRISBUS	5.000.805.284	1 E 18	PR 100	3	78
IRISBUS	5.000.805.284	1 E 18	PR 100-GX 107 Heuliez	3	78
IRISBUS	5.000.805.284	1 E 18	PR 14	1,3	78
IRISBUS	5.000.805.284	1 E 18	PR 180-GX 187 Heuliez		78
IRISBUS	5.000.954.176	1 E 21 D	FR 1	3	81
IRISBUS	5.000.954.176	1 E 21 D	Tracer	3	81
IRISBUS	5.001.021.414	1 E 23 A	Agora/Crystallis 2004	1,3	83
IRISBUS	5.001.829.866	1 E 25	Tracer Export	3	84
IRISBUS	5.001.829.866	1 E 25	Tracer R 333	3	84
IRISBUS	5.001.843.640	2 F 18	Agora/Crystallis < 2004	3	104
IRISBUS	5.006.172.377	1 E 23 A-1	Agora/Crystallis > 2004	1,3	83
IRISBUS	5.010.531.181	2 F 18-1	Agora/Crystallis < 2004		104

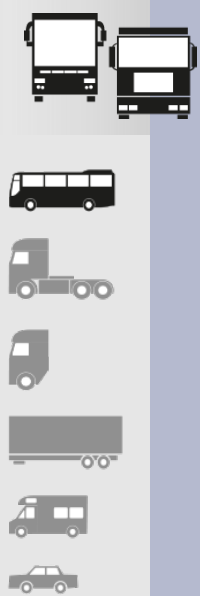



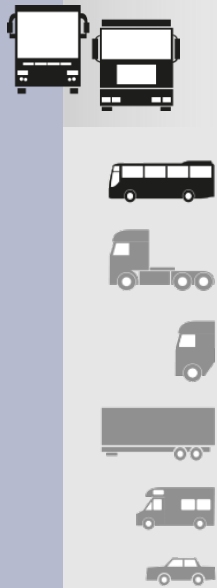

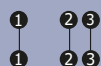

1 Front Axle 2 Mid or Driven Axle
3 Rear or Tag Axle



OE	OE #	PHX			
IRISBUS	500.324.098	1 E 21 D	Cityclass	1	81
IRISBUS	503.129.220	1 E 23 B	Citelis (2nd generation)	3	84
IRISBUS	503.130.261	1 E 25 A	Citelis (2nd generation)	1	85
IRISBUS	504.097.615	1 E 23 B-1	Urbanway/Citelis/Crealis	3	84
IVECO Bus	299729	1 E 23 A			83
IVECO Bus	2997885	1 E 23 B-1	Urbanway/Citelis/Crealis	3	84
IVECO Bus	41822247	1 E 25	Bus 470	1,3	84
IVECO Bus	41822247	1 E 25	Bus 471	1,3	84
IVECO Bus	41822247	1 E 25	Bus 570	1,3	84
IVECO Bus	41822247	1 E 25	Bus 670	1,3	84
IVECO Bus	4714025	1 E 21-6	Bus 220	3	82
IVECO Bus	4722525	1 E 21-6	Bus 220	1	82
IVECO Bus	4722525	1 E 21-6	Bus 320	1	82
IVECO Bus	4722525	1 E 21-6	Carrozeria		82
IVECO Bus	4746733	1 E 25			84
IVECO Bus	5003 01452	1 F 20 A			89
IVECO Bus	5003 24098	1 E 21 D			81
IVECO Bus	503130506	1 E 23 A			83
IVECO Bus	504097615	1 E 23 B-1	Urbanway/Citelis/Crealis	3	84
IVECO Bus	5254025	1 E 21-6		1	82
IVECO Bus	6453741	2 E 23 A			104
IVECO Bus	6657150	1 E 21-6		1	82
IVECO Bus	93166129	1 E 14	Bus 490 (Sicca)	1	77
IVECO Bus	93197594	1 E 23			83
IVECO Bus	97108363	1 F 20 A	Bus 5522		89
Jelcz		1 E 16			77
Jelcz		1 E 16-1			78
Jonckheere		1 F 21			91
Jonckheere		2 E 18 B			103
Kässbohrer		1 E 21 C		2	81
Kässbohrer	4.731.012.000	1 E 25	SG 052		84
Kässbohrer	4.731.031.000	1 E 25	S 228 DT		84
Kässbohrer	4.731.042.000	1 E 25	S 120 GV/HV		84
Kässbohrer	4.731.042.000	1 E 25	S 125		84
Kässbohrer	4.731.042.000	1 E 25	S 1305		84
Kässbohrer	4.731.042.000	1 E 25	S 140 E/ES/H		84
Kässbohrer	4.731.042.000	1 E 25	S 150		84
Kässbohrer	4.731.042.000	1 E 25	S 150 E/H		84
Kässbohrer	4.731.042.000	1 E 25	S 180		84
Kässbohrer	4.731.042.000	1 E 25	S 200		84
Kässbohrer	4.731.042.000	1 E 25	S 209		84
Kässbohrer	4.731.042.000	1 E 25	S 210 H/HD		84







1 Front Axle 2 Mid or Driven Axle
3 Rear or Tag Axle

OE	OE #	PHX		  	 
Kässbohrer	4.731.042.000	1 E 25	S 211		84
Kässbohrer	4.731.042.000	1 E 25	S 212		84
Kässbohrer	4.731.042.000	1 E 25	S 213		84
Kässbohrer	4.731.042.000	1 E 25	S 214		84
Kässbohrer	4.731.042.000	1 E 25	S 215		84
Kässbohrer	4.731.042.000	1 E 25	S 216 HSD		84
Kässbohrer	4.731.042.000	1 E 25	S 228 DT		84
Kässbohrer	4.731.042.000	1 E 25	SG 052		84
Kässbohrer	4.731.042.000	1 E 25	SG 150		84
Kässbohrer	4.731.042.000	1 E 25	SG 175		84
Kässbohrer	4.731.042.000	1 E 25	SG 180		84
Kässbohrer	4.731.042.000	1 E 25	SG 200		84
Kässbohrer	4.731.042.000	1 E 25	SG 98		84
Kässbohrer	4.771.143.000	1 E 21			80
Kässbohrer	4.771.170.000	1 E 21	S 110		80
Kässbohrer	4.771.170.000	1 E 21	S 12		80
Kässbohrer	4.771.170.000	1 E 21	S 120 GV/HV		80
Kässbohrer	4.771.170.000	1 E 21	S 125		80
Kässbohrer	4.771.170.000	1 E 21	S 1305		80
Kässbohrer	4.771.170.000	1 E 21	S 14		80
Kässbohrer	4.771.170.000	1 E 21	S 140 E/ES/H		80
Kässbohrer	4.771.170.000	1 E 21	S 15 L		80
Kässbohrer	4.771.170.000	1 E 21	S 150 E/H		80
Kässbohrer	4.771.170.000	1 E 21	S 180		80
Kässbohrer	4.771.170.000	1 E 21	S 200		80
Kässbohrer	4.771.170.000	1 E 21	S 209		80
Kässbohrer	4.771.170.000	1 E 21	S 210 H/HD		80
Kässbohrer	4.771.170.000	1 E 21	S 211		80
Kässbohrer	4.771.170.000	1 E 21	S 212		80
Kässbohrer	4.771.170.000	1 E 21	S 213		80
Kässbohrer	4.771.170.000	1 E 21	S 214		80
Kässbohrer	4.771.170.000	1 E 21	S 215		80
Kässbohrer	4.771.170.000	1 E 21	S 216 HSD		80
Kässbohrer	4.771.170.000	1 E 21	S 228 DT		80
Kässbohrer	4.771.170.000	1 E 21	SG 052		80
Kässbohrer	4.771.170.000	1 E 21	SG 175		80
Kässbohrer	4.771.170.000	1 E 21	SG 180		80
Kässbohrer	4.771.170.000	1 E 21	SG 98		80
Kässbohrer	4.771.170.000	1 E 21	SG 52		80
Kässbohrer	4.771.427.000	1 E 25	S 212 HD		84
Kässbohrer	4.771.427.000	1 E 25	S 215 V		84
Kässbohrer	4.771.440.000	1 E 25			84

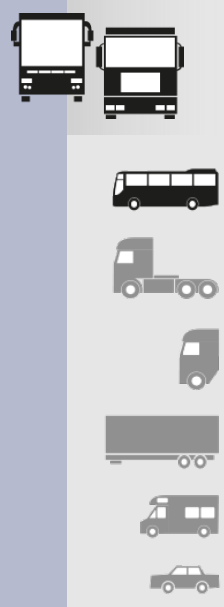



1 Front Axle 2 Mid or Driven Axle
3 Rear or Tag Axle



OE	OE #	PHX			
Kässbohrer	4.771.441.000	1 E 21	SG 180		80
LAG		2 E 23	E 180 Z	1	103
LAG		2 E 23	EOS	1	103
LAG		2 E 23	Galaxy	1	103
LAG		2 E 23	Panoramic	1	103
LIAZ		1 E 26 A			86
MAN	81.43601.0017	1 E 21			80
MAN	81.43601.0018	1 E 32		1	88
MAN	81.43601.0056	1 F 32 A	Bus 362 H	1,3	94
MAN	81.43601.0057	1 F 32 A	MAN 292 /F	3	94
MAN	81.43601.0058	1 F 32 A	MAN 292/362 H	3	94
MAN	81.43601.0076	1 F 32 A	MAN 362 F	3	94
MAN	81.43601.0095	1 F 21 C-5	EL 202	1	92
MAN	81.43601.0097	1 F 21 C-5	MAN 322/422	1	92
MAN	81.43601.0100	1 F 21 C-5	NL 202 München	1	92
MAN	81.43601.0102	1 F 21 C-5	NG 272 Podestlos	1	92
MAN	81.43601.0105	1 F 21 C-5	NL 202 F	1	92
MAN	81.43601.0108	1 F 20 A	18 272	1	89
MAN	81.43601.0108	1 F 20 A	19 322/422	1,3	89
MAN	81.43601.0108	1 F 20 A	EL 202	1	89
MAN	81.43601.0108	1 F 20 A	F 90/M 90	1,3	89
MAN	81.43601.0108	1 F 20 A	ND 202	1	89
MAN	81.43601.0108	1 F 20 A	NG 272 Podestlos	1	89
MAN	81.43601.0108	1 F 20 A	NL 202 F	1	89
MAN	81.43601.0108	1 F 20 A	NL 202 München	1	89
MAN	81.43601.0108	1 F 20 A	NL 202 Podestlos	1	89
MAN	81.43601.0108	1 F 20 A	NL CNG Podestl.	1	89
MAN	81.43601.0126	1 F 21 C-5	NL 202 Podestlos	1,3	92
MAN	81.43601.0126	1 F 21 C-5	NL CNG Podestl.	1	92
MAN	81.43601.0126	1 F 21 C-5	NM 152 Midibus	1	92
MAN	81.43601.0126	1 F 21 C-5	SL 250	1,3	92
MAN	81.43601.0126	1 F 21 C-5	UEL 242	1,3	92
MAN	81.43601.0138	1 F 21 C-5		1	92
MAN	81.43601.6002	1 D 23 C-1			18
MAN	81.43601.6023	1 D 23 C-1			18
MAN	81.43601.6029	1 D 23 C-1			18
MAN	81.43601.6030	1 D 23 C-1			18
MAN	90.83112.0144	1 E 25	10 U 210 R12	1,2,3	84
MAN	90.83112.0144	1 E 25	11 U 219 R13	1,3	84
MAN	90.83112.0144	1 E 25	12 U 210 R12	1,3	84
MAN	90.83112.0144	1 E 25	BS 100 GT SKD	1,3	84
MAN	90.83112.0144	1 E 25	BS 120 N	1,3	84



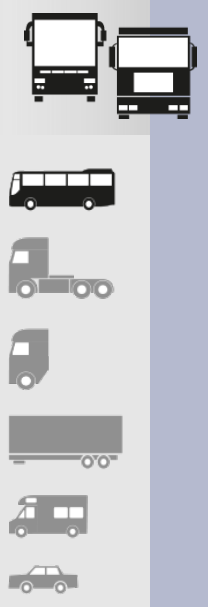

1 Front Axle 2 Mid or Driven Axle
3 Rear or Tag Axle

OE	OE #	PHX			
MB Tuerk	A 000 327 01 01	1 E 21	O 404	3	80
MB Tuerk	A 000 327 01 01	1 E 21	O 405	1,3	80
MB Tuerk	A 000 327 01 01	1 E 21	O 405 N	1	80
MB Tuerk	A 356 327 00 01	1 E 23	O 404	1	83
MB Tuerk	A 613 327 00 01	1 E 21		1,3	80
MB Tuerk	A 613 327 01 01	1 E 23	O 404	1	83
MB Tuerk	A 613 327 02 01	1 E 25		1,3	84
MCW	X 664 1056	2 E 23 A	Metro Bus Mk I / II	3	104
MCW	X 664 1056	2 E 23 A	Metro Liner	3	104
Neoplan	1001 10 100	1 F 32 B			95
Neoplan	1001 10 200	1 E 32			88
Neoplan	1001 10 300	1 E 21	Eurostar	3	80
Neoplan	1001 10 300	1 E 21	N 907	1,3	80
Neoplan	1001 12 250	1 E 25	Cityliner	1	84
Neoplan	1001 12 250	1 E 25	Jetliner	3	84
Neoplan	1001 12 250	1 E 25	N 407	3	84
Neoplan	1001 12 250	1 E 25	NB 26 L	1	84
Neoplan	1001 12 250	1 E 25	Skyliner	3	84
Neoplan	1001 12 250	1 E 25	TR 40	1,3	84
Neoplan	1001 12 251	1 E 32	Cityliner	3	88
Neoplan	1001 12 251	1 E 32	N 116. N 117/2. /3. N 122/3	1,3	88
Neoplan	1001 12 251	1 E 32	N 326/3	1,3	88
Neoplan	1001 12 251	1 E 32	N 424. N 426	1,3	88
Neoplan	1001 12 251	1 E 32	N 912. N 940	1,3	88
Neoplan	1001 12 251	1 E 32	N 940	1	88
Neoplan	1001 12 251	1 E 32	NB 26 L	3	88
Neoplan	1001 12 251	1 E 32	Skyliner	1	88
Neoplan	1001 12 251	1 E 32	TR 8. TR 12	1,3	88
Neoplan	1001 12 254	1 E 21	Eurostar	1,3	80
Neoplan	1001 12 254	1 E 21	Jetliner	1	80
Neoplan	1001 12 254	1 E 21	N 208	1	80
Neoplan	1001 12 254	1 E 21	N 210	1	80
Neoplan	1001 12 254	1 E 21	N 407	1	80
Neoplan	1001 12 254	1 E 21	N 907	1,3	80
Neoplan	1001 12 254	1 E 21	ND 6	1	80
Neoplan	1001 12 254	1 E 21	NH 8 L - NH 10 L	1,2	80
Neoplan	1001 12 300	1 F 21		3	91
Neoplan	1021 00 200	1 F 32 B		3	95
Neoplan	AA 10-01-001	1 E 25	Eurostar	3	84
Neoplan	AA 10-01-001	1 E 25	Most	3	84
Neoplan	AA 10-01-001	1 E 25	N 208	1	84
Neoplan	AA 10-01-001	1 E 25	N 209	1	84





1 Front Axle 2 Mid or Driven Axle
3 Rear or Tag Axle



OE	OE #	PHX			
Neoplan	AA 10-01-001	1 E 25	N 210	1	84
Neoplan	AA 10-01-001	1 E 25	N 212/H	1	84
Neoplan	AA 10-01-001	1 E 25	N 213/H	1	84
Neoplan	AA 10-01-001	1 E 25	N 214/H	1	84
Neoplan	AA 10-01-001	1 E 25	N 216/H	1	84
Neoplan	AA 10-01-001	1 E 25	N 221	1	84
Neoplan	AA 10-01-001	1 E 25	N 314. N 316	1	84
Neoplan	AA 10-01-001	1 E 25	N 414. N 416. N 421	1	84
Neoplan	AA 10-01-001	1 E 25	N 922	3	84
Neoplan	AA 10-01-001	1 E 25	N 940	3	84
Neoplan	AA 10-01-001	1 E 25	ND 6	3	84
Neoplan	AA 10-01-001	1 E 25	NH 12 L - NH 25 L	1	84
Neoplan	AA 10-01-001	1 E 25	NH 8 L - NH 10 L	3	84
Neoplan	AA 10-01-001	1 E 25	Skyliner	1	84
Neoplan	AA 10-01-001	1 E 25	TR 40	1,3	84
Neoplan	AA 10-01-002	1 E 32	N 116	1,3	88
Neoplan	AA 10-01-002	1 E 32	N 117/2/3	1,3	88
Neoplan	AA 10-01-002	1 E 32	N 122	1,3	88
Neoplan	AA 10-01-002	1 E 32	N 122/2/3	1,3	88
Neoplan	AA 10-01-002	1 E 32	N 138	1,3	88
Neoplan	AA 10-01-002	1 E 32	N 212/H	3	88
Neoplan	AA 10-01-002	1 E 32	N 213/H	3	88
Neoplan	AA 10-01-002	1 E 32	N 214/H	3	88
Neoplan	AA 10-01-002	1 E 32	N 216/H	3	88
Neoplan	AA 10-01-002	1 E 32	N 221	3	88
Neoplan	AA 10-01-002	1 E 32	N 314. N 316	3	88
Neoplan	AA 10-01-002	1 E 32	N 316/MK	1,3	88
Neoplan	AA 10-01-002	1 E 32	N 326/3	1,3	88
Neoplan	AA 10-01-002	1 E 32	N 414. N 416. N 421	3	88
Neoplan	AA 10-01-002	1 E 32	N 424. N 426	1,3	88
Neoplan	AA 10-01-002	1 E 32	N 912	1,3	88
Neoplan	AA 10-01-002	1 E 32	N 922	1	88
Neoplan	AA 10-01-002	1 E 32	N 940	1	88
Neoplan	AA 10-01-002	1 E 32	NH 12 L - NH 25 L	3	88
Neoplan	AA 10-21-300	1 E 32			88
Optare	L5820005	1 F 21 C-5	Bus and Coach		92
Optare	R5800001	1 E 10 C	Bus and Coach		77
Optare	R5800068	1 E 10 C			77
Pegaso		1 F 21	B55	3	91
Pegaso		1 F 21 C-2			92
Pegaso	197145	1 E 21 C			81
Pegaso	4716989	1 E 21 C	5036 S	3	81



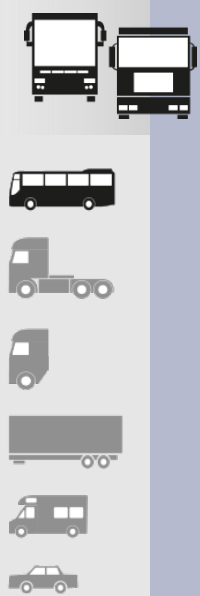

1 Front Axle 2 Mid or Driven Axle
3 Rear or Tag Axle

OE	OE #	PHX			
Pegaso	4716989	1 E 21 C	6100	1,3	81
Pegaso	769388	1 E 21 C			81
Pegaso	794686	2 E 23	5231	3	103
Pegaso	795097	2 E 23	5231	1	103
Pegaso	8188539	1 F 20 A	5035 N	3	89
Pegaso	8188539	1 F 20 A	6031	1,3	89
Pegaso	8188539	1 F 20 A	6035	3	89
Pegaso	8188539	1 F 20 A	6038	1,3	89
Pegaso	8188539	1 F 20 A	6046	1,3	89
Pegaso	93166129	1 E 14	5522	1	77
Pegaso	93166129	1 E 14	6522	1	77
Portesi	700 176	1 E 21-6			82
RABA		1 E 25			84
Roman SA		1 E 16			77
Roman SA	89436016005	1 E 16-1			78
Scania	1434506	1 DF 20 A-4		2,3	34
Scania	1440301	1 DF 23 B-1			44
Scania	1440302	1 DF 23 A-1	AMI700	1	42
Scania	1440303	1 DF 20 C-1		1	36
Scania	1440304	1 DF 20 A-3	ADA1300, ASA1300	2	34
Scania	1440305	1 DF 20 A-2	ADA1300	2	34
Scania	1440306	1 DF 20 A-1		2,3	33
Scania	1440307	1 DF 23 B-2	ASA701, ARA860	3	44
Scania	1440308	1 DF 23 A-3			43
Scania	1440860	1 DF 23 B-2		3	44
Scania	1475106	1 DF 20 C-1		1	36
Scania	1521114	1 DF 20 C-1		1	36
Scania	1726237	1 DF 23 B-4	Scania F-, K-, N-Series	1	45
Scania	1726238	1 DF 23 A-2	AMI700	1	43
Scania	1726239	1 DF 20 C-2	AMA780	1	37
Scania	1726240	1 DF 20 A-5	ADA1300, ASA1300	2	35
Scania	1726241	1 DF 20 A-6	ADA1300	2	35
Scania	1726242	1 DF 20 A-7	ADA1300	2,3	35
Scania	1726243	1 DF 20 A-8	tandem load 17.5 ton	2,3	36
Scania	1726243	1 DF 20 A-8	ADA1250, ASA1150	2,3	36
Scania	1726246	1 DF 23 B-5	ASA701, ARA860	3	45
Scania	1726247	1 DF 23 A-3	ASA701, ARA860	3	43
Scania	1726247	1 DF 23 A-3	tandem load 19 ton	3	43
Scania	1726257	1 DF 20 C-2		1	37
Scania	2024281	1 DF 23 B-4	Scania F,K,N-Series	1	45
Scania	2024283	1 DF 20 C-4		1	37
Scania	2024284	1 DF 20 C-4	AMA780	1	37









1 Front Axle 2 Mid or Driven Axle
3 Rear or Tag Axle



OE	OE #	PHX			
Scania	2024285	1 DF 20 C-4		1	37
Scania	2024287	1 DF 20 A-9	ADA1300	2,3	36
Scania	2024288	1 DF 20 A-10		2,3	33
Scania	2024290	1 DF 20 A-9		2,3	36
Scania	411622	2 E 23			103
Scania	411623	2 E 23	BR 116	1,3	103
Scania	411623	2 E 23	CR76 VA	1	103
Scania	411623	2 E 23	K 112 DR	1	103
Scania	411623	2 E 23	K 112 OR	1	103
Scania	411623	2 E 23	K 112 TR	1	103
Scania	411623	2 E 23	K 113 T	1	103
Scania	411623	2 E 23	K 113 TLA	1	103
Scania	411623	2 E 23	K 82-112	1	103
Scania	411623	2 E 23	K 93 / K113	1	103
Scania	411623	2 E 23	L 113	1	103
Scania	411623	2 E 23	L 113 CLD	1	103
Scania	411623	2 E 23	L 92 / K 112	1	103
Scania	411623	2 E 23	L 92 / K 113	1	103
Scania	411623	2 E 23	N 113 C	1	103
Scania	411627	2 E 18 A	K 112 DR	3	103
Scania	411627	2 E 18 A	K 112 OR	3	103
Scania	411627	2 E 18 A	K 112 TR	3	103
Scania	411627	2 E 18 A	K112 HDR	3	103
Scania	411627	2 E 18 A	K113 DR	3	103
Scania	523229	1 E 21-6	Bus (South America)	2,3	82
Sicca	4840 005	1 E 21-6			82
SMB		1 DK 23 K-1			67
SMB		1 E 32			88
SMB		1 F 32 B			95
Solaris	0000 194 640	1 DF 25 A-22	Urbino, Vacanza	1	49
Solaris	0000 194 642	1 DF 25 A-21	Urbino, Vacanza	1	49
Solaris	0000 194 647	1 DF 25 A-20	Urbino, Vacanza	3	48
Solaris	020701-0000-392-836	1 DF 25 A-1	Urbino, Vacanza	3	47
Solaris	020701-0000-392-840	1 DF 25 A-11	Urbino, Vacanza	1	47
Solaris	020701-0000-392-842	1 DF 25 A-2	Urbino, Vacanza	1	48
Solaris	1001 101 040	1 DF 25 A-2	Urbino, Vacanza	1	48
Solaris	1001 101 042	1 DF 25 A-12	Urbino, Vacanza	1	48
Solaris	1001 101 044	1 DF 25 A-7	Urbino, Vacanza	3	50
Solaris	1001 101 045	1 DF 25 A-12	Urbino, Vacanza	1	48
Solaris	1001 101 047	1 DF 25 A-7	Urbino, Vacanza	3	50
Solaris	1001 101 050	1 DF 25 A-2	Urbino, Vacanza	1	48
Solaris	1001 101 052	1 DF 25 A-11	Urbino, Vacanza	1	47





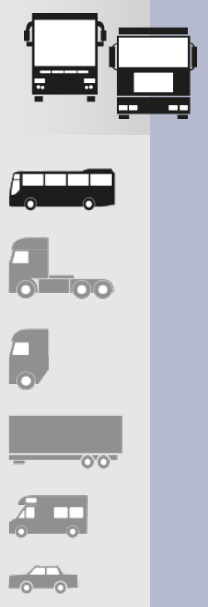

1 Front Axle 2 Mid or Driven Axle
3 Rear or Tag Axle

OE	OE #	PHX		  	 
Solaris	1001 101 058	1 DF 25 A-1 NP	Urbino, Vacanza	3	47
Solaris	1001 101 060	1 DF 25 A-1	Urbino, Vacanza	3	47
Solaris	1070 001 000	1 DF 25 A-2	Urbino, Vacanza	1	48
Solaris	1070 002 000	1 DF 25 A-1	Urbino, Vacanza	3	47
Solaris	P-0000 194 640	1 DF 25 A-22	Urbino, Vacanza	1	49
Solaris	P-0000 194 642	1 DF 25 A-21	Urbino, Vacanza	1	49
Solaris	P-0000 194 647	1 DF 25 A-20	Urbino, Vacanza	3	48
Solaris	P-1001 101 040	1 DF 25 A-2	Urbino, Vacanza	1	48
Solaris	P-1001 101 042	1 DF 25 A-12	Urbino, Vacanza	1	48
Solaris	P-1001 101 044	1 DF 25 A-7	Urbino, Vacanza	3	50
Solaris	P-1001 101 045	1 DF 25 A-12	Urbino, Vacanza	1	48
Solaris	P-1001 101 047	1 DF 25 A-7	Urbino, Vacanza	3	50
Solaris	P-1001 101 050	1 DF 25 A-2	Urbino, Vacanza	1	48
Solaris	P-1001 101 052	1 DF 25 A-11	Urbino, Vacanza	1	47
Solaris	P-1001 101 058	1 DF 25 A-1 NP	Urbino, Vacanza	3	47
Solaris	P-1001 101 060	1 DF 25 A-1	Urbino, Vacanza	3	47
Solaris	P-1070 001 000	1 DF 25 A-2	Urbino, Vacanza	1	48
Solaris	P-1070 002 000	1 DF 25 A-1	Urbino, Vacanza	3	47
Temsa	TE771107Y	1 F 21 C-5	Safari		92
Temsa	TE771107Y	1 F 21 C-5	Diamond		92
Temsa	TE771107Y	1 F 21 C-5	Eurosafari		92
Van Hool		1 E 32			88
Van Hool	624319-420	1 E 21		1,3	80
Van Hool	624319-610	1 E 21	AM 500	1,3	80
Van Hool	624319-610	1 E 21	AV 138		80
Van Hool	624319-610	1 E 21	T 809 Alizee	1,3	80
Van Hool	624319-610	1 E 21	T 812-815 Alizee	1,3	80
Van Hool	624319-610	1 E 21	T 815 Acron	1,3	80
Van Hool	624319-610	1 E 21	T 815 Alicron	1,3	80
Van Hool	624319-610	1 E 21	T 815 Altano	1,3	80
Van Hool	624319-610	1 E 21	T 815 Astron	1,3	80
Van Hool	624319-610	1 E 21	T 818 Astron Art.	3	80
Van Hool	624319-610	1 E 21	T 820 AMGNT Art.	3	80
Van Hool	624319-610	1 E 21	T 824 AMAGNT	1,3	80
Van Hool	624319-610	1 E 21	T 824 Astrom.Art.	3	80
Van Hool	624319-610	1 E 21	VH 440/4	1,3	80
Van Hool	624319-610	1 E 21	VH 540	1,3	80
Van Hool	624319-610	1 E 21	VHA 120	1,3	80
Van Hool	624319-610	1 E 21	VHAU 115	1,2,3	80
Van Hool	624319-610	1 E 21	VHAU 115/1	1,3	80
Van Hool	624319-610	1 E 21	VHC 441	1,3	80
Van Hool	624319-610	1 E 21	VHDAU 115	1,3	80

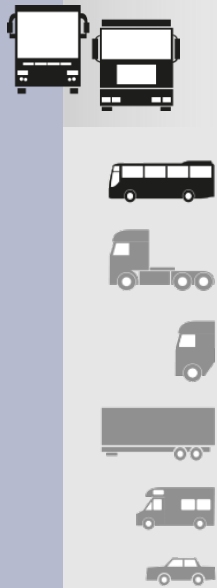



1 Front Axle 2 Mid or Driven Axle
3 Rear or Tag Axle



OE	OE #	PHX			
Van Hool	624319-610	1 E 21	VHDAU 115/1	1,3	80
Van Hool	624319-610	1 E 21	VHF 309 AU 93.95	1,3	80
Van Hool	624319-610	1 E 21	VHF 409 AU 93.95	1,3	80
Van Hool	624319-610	1 E 21	VHF 440 B	1	80
Van Hool	624319-610	1 E 21	VHF 440. 440/4	1,3	80
Van Hool	624319-610	1 E 21	VHF 441	1,3	80
Van Hool	624319-610	1 E 21	VHF 444. B. C	1,3	80
Van Hool	624319-640	1 F 32 A	TD 824 Astromega	3	94
Van Hool	624319-640	1 F 32 A	VHAU 115/1	3	94
Van Hool	624319-640	1 F 32 A	VHCAU 124	3	94
Van Hool	624319-640	1 F 32 A	VHD 119	3	94
Van Hool	624319-640	1 F 32 A	VHDAI 114	3	94
Van Hool	624319-640	1 F 32 A	VHDAI 119. 119/2	3	94
Van Hool	624319-640	1 F 32 A	VHF 332	3	94
Van Hool	624319-640	1 F 32 A	VHF 440 B	3	94
Van Hool	624319-670	1 E 25			84
Van Hool	624319-690	1 E 25	T 818 Astron Art.	1	84
Van Hool	624319-690	1 E 25	T 820 AMGNT Art.	1	84
Van Hool	624319-690	1 E 25	T 824 Astrom.Art.	1	84
Van Hool	624319-690	1 E 25	TD 824 Astromega	1	84
Van Hool	624319-700	1 E 25			84
Van Hool	624319-860	1 E 18			78
VDL Bus	0 067 504	1 DF 25-1 NP		3	51
VDL Bus	0 377 498	1 DF 25-14			52
VDL Bus	0 513 982	1 DF 25-3 NP			53
VDL Bus	0 526 651	1 DF 25-15			53
VDL Bus	0 578 361	1 E 32	SB 2000	3	88
VDL Bus	0 578 361	1 E 32	SB 201	3	88
VDL Bus	0 627 584	1 F 21 A			92
VDL Bus	0 638 148	1 F 32 A	MB 200		94
VDL Bus	0 638 148	1 F 32 A	MB 230		94
VDL Bus	0 638 148	1 F 32 A	SB 1602		94
VDL Bus	0 638 148	1 F 32 A	SB 1603		94
VDL Bus	0 638 148	1 F 32 A	SB 1604		94
VDL Bus	0 638 148	1 F 32 A	SB 1605		94
VDL Bus	0 689 677	1 E 21	SB 2000	1	80
VDL Bus	0 689 677	1 E 21	SB 201	1	80
Volvo	0 365 431	2 B 12 R	B 58		100
Volvo	0 365 461	2 B 12 R	B 58		100
Volvo	1 076 420	1 DF 17 C-1			32
Volvo	1 134 445	1 E 21	B 10 M MK III. III G	3	80
Volvo	1 134 445	1 E 21	B 10 M MK IV	3	80



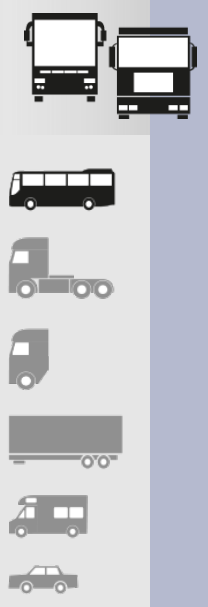

1 Front Axle 2 Mid or Driven Axle
3 Rear or Tag Axle

OE	OE #	PHX			
Volvo	1 134 445	1 E 21	B 10 M. B 10 M 4	3	80
Volvo	1 134 445	1 E 21	B 10 R	1	80
Volvo	1 134 445	1 E 21	B 12	3	80
Volvo	1 134 445	1 E 21	C 10 M	3	80
Volvo	1 134 445	1 E 21	F 4. 6. 10. 12. FL6	3	80
Volvo	1 134 446	1 F 32 A	B 10 R	3	94
Volvo	1 137 888	1 E 25	B 10 M MK III	1	84
Volvo	1 137 888	1 E 25	B 10 M. C10 M	1	84
Volvo	1 137 888	1 E 25	C 10 M	3	84
Volvo	1 137 888	1 E 25	City Bus	1	84
Volvo	1 137 888	1 E 25	F 7	1	84
Volvo	1 199 893	1 E 21			80
Volvo	1 590 136	1 F 21	B 58	3	91
Volvo	1 590 136	1 F 21	F 10/12		91
Volvo	1 590 136	1 F 21	F... (except FL 6)	3	91
Volvo	1 590 136	1 F 21	F10. F12	3	91
Volvo	1 590 136	1 F 21	FL 6. FL 7	3	91
Volvo	1 590 136	1 F 21	FL 611. FL 614. FL 617	3	91
Volvo	1 590 136	1 F 21	National Mk 1 / 11	3	91
Volvo	1 593 700	2 B 49 R-B			102
Volvo	1 622 111	1 E 21			80
Volvo	20 535 875	1 E 18 D	B6BLE/ B7L/ B7R/ B9S/ B10B/ B10L	2,3	79
Volvo	20 535 876	1 E 18 D-01	B7L/ B7LDD./ B9S./ B9TL	2,3	79
Volvo	20 535 877	1 E 18 D-02	B6BLE/ B7L/ B7R/ B9S/ B10B/ B10L	2,3	79
Volvo	20 540 789	1 E 21 B	B6R / B7R / B9R	2,3	81
Volvo	20 540 792	1 E 18 E	B6R / B7R / B9R	2,3	80
Volvo	20 573 108	1 DF 17-1	B 12 B	3	32
Volvo	20 703 452	1 DF 25 B-1 NP	B6R/ B7R/ B7L/ B9L/ B9S/ B9TL/ B	1	50
Volvo	20 725 459	1 E 18 D-03	B9L/ B9LA/ B9S	2,3	80
Volvo	21 057 936	1 DF 25 C-1		1	51
Volvo	21 057 939	1 DF 25 B-1 NP	B6R/ B7R/ B7L/ B9L/ B9S/ B9TL/ B	1	50
Volvo	21 097 433	1 DF 25 C-1		1	51
Volvo	21 347 075	1 E 18 C	B6R / B7R / B9R	2,3	78
Volvo	21 513 833	1 DF 25 C-1	B7RLE/ B9LE/ B9RLE/ B9S/ B9TL	1	51
Volvo	21 513 836	1 DF 25 C-1 NP	B7RLE/ B9LE/ B9RLE/ B9S/ B9TL	1	51
Volvo	21 836 531	1 E 18 C	B6R / B7R / B9R	2,3	78
Volvo	21 836 533	1 E 21 F	B6R / B7R / B9R	2,3	82
Volvo	3 027 271	2 G 20	B 10 M		105
Volvo	3 027 271	2 G 20	B 10 M MK 4	1,3	105
Volvo	3 027 271	2 G 20	B 10 M MK III G	3	105
Volvo	3 027 272	2 G 20 A	B 10 B	1,3	105
Volvo	3 027 272	2 G 20 A	B 10 M 4	1	105





1 Front Axle 2 Mid or Driven Axle
3 Rear or Tag Axle



OE	OE #	PHX			
Volvo	3 027 272	2 G 20 A	B 10 M MK III G	1	105
Volvo	3 027 272	2 G 20 A	B 10 M MK IV	1	105
Volvo	3 027 272	2 G 20 A	B 12	1	105
Volvo	3 116 354	2 E 18 B			103
Volvo	3 116 983	2 E 23 A			104
Volvo	3 159 252	1 E 21	B 7	3	80
Volvo	3 195 253	1 E 25	B 7	1	84
Volvo	6 882 797	2 B 12 R	B 58		100
Volvo	70 311 683	1 DF 25 C-1		1	51
Volvo	70 321 692	1 DF 17-1		3	32
Volvo	70 376 919	1 DF 17-1		3	32
Volvo Leyland	10 904 403	2 E 23 A	Lion	3	104
Volvo Leyland	3 116 354	2 E 18 B	Lynx	1	103
Volvo Leyland	3 116 354	2 E 18 B	Olympian	1	103
Volvo Leyland	3 116 354	2 E 18 B	Royal Tiger	1	103
Volvo Leyland	3 116 354	2 E 18 B	Super Volvo	3	103
Volvo Leyland	3 116 354	2 E 18 B	Tiger	1	103
Volvo Leyland	3 116 354	2 E 18 B	Titan	1	103
Volvo Leyland	3 116 983	2 E 23 A	National MK I / II	1	104
Volvo Leyland	3 116 983	2 E 23 A	Olympian	3	104
Volvo Leyland	3 116 983	2 E 23 A	Tiger	3	104
Volvo Leyland	AAU 2542	2 E 18 B	Lynx		103
Volvo Leyland	AAU 2544	2 E 23 A	Lion	3	104
ZF Sachs	00 17 48 000 160	1 F 21 C-5	MAN Bus		92
ZF Sachs	00 17 70 000 160	1 F 21 C-5	MAN Bus	1	92
ZF Sachs	0501 209 513	1 E 25-5		1	85
ZF Sachs	0501 215 443	1 E 25-5		1	85
ZF Sachs	0501 215 444	1 E 26 A-14		2,3	87
ZF Sachs	0501 215 602	1 E 25-9	RL85A, RL75EC, AVN132	1,3	86
ZF Sachs	0501 215 603	1 E 26 A-14	AV132	2,3	87
ZF Sachs	0501 217 174	1 E 25-9		1	86
ZF Sachs	0501 312 548	1 E 10 C		1	77
ZF Sachs	0501 323 798	1 E 26 A	AV132	3	86
ZF Sachs	0501 323 863	1 E 25			84



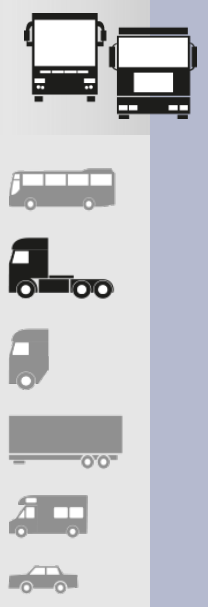

1 Front Axle 2 Mid or Driven Axle
3 Rear or Tag Axle

OE	OE #	PHX			
DAF	0 067 504	1 DF 25-1 NP			51
DAF	0 388 165	1 DF 25-11		2,3,4	52
DAF	0 388 167	1 DF 25-13			52
DAF	0 513 982	1 DF 25-3 NP			53
DAF	0 638 148	1 F 32 A	FA 2135		94
DAF	0 638 148	1 F 32 A	FA 2200		94
DAF	0 638 148	1 F 32 A	FA 2800		94
DAF	0 638 148	1 F 32 A	FA 2805		94
DAF	0 638 148	1 F 32 A	FT 2300		94
DAF	0 638 148	1 F 32 A	FT 2800		94
DAF	0 818 225	1 F 32 B	FA 1300		95
DAF	0 818 225	1 F 32 B	FA 2125		95
DAF	0 818 225	1 F 32 B	FA 2305 DHS		95
DAF	0 818 225	1 F 32 B	FA 2305 DHT		95
DAF	0 818 225	1 F 32 B	FA 2500 DHS		95
DAF	0 818 225	1 F 32 B	FA 2500 DHT		95
DAF	0 818 225	1 F 32 B	FA 2505 DHS		95
DAF	0 818 225	1 F 32 B	FA 3300		95
DAF	0 818 225	1 F 32 B	FA 3605		95
DAF	0 818 225	1 F 32 B	FA G2505 DHS		95
DAF	0 818 225	1 F 32 B	FT 2100		95
DAF	0 818 225	1 F 32 B	FT 2125		95
DAF	0 818 225	1 F 32 B	FT 3300		95
DAF	0 818 225	1 F 32 B	FT 3600		95
DAF	1 279 141	1 DF 17 B-3		1	31
DAF	1 384 273	1 D 28 A-2			20
DAF	1 407 329	1 D 23 G-1	LF 2. LF 4	3	19
DAF	1 529 833	1 DF 25-11		2,3,4	52
DAF	1 529 835	1 DF 17 B-3		1	31
DAF	1 697 678	1 DF 25-11	CF 65	2,3,4	52
DAF	1 697 678	1 DF 25-11	CF 75-85	2,3,4	52
DAF	1 697 678	1 DF 25-11	LF 45-55	2,3,4	52
DAF	1 697 678	1 DF 25-11	XF 95-105	2,3,4	52
DAF	1 698 434	1 DF 17 B-3	CF 65	1	31
DAF	1 698 434	1 DF 17 B-3	CF 75-85	1	31
DAF	1 698 434	1 DF 17 B-3	LF 45-55	1	31
DAF	1 698 434	1 DF 17 B-3	XF 95-105	1	31
DAF	1 794 420	1 DF 23 A-4		3	43
Hanomag	536 905 265	1 E 25	F 163 LL	3	84
Hanomag	536 905 265	1 E 25	F 163 LL. SL	3	84
Hanomag	536 905 265	1 E 25	F 221 LEL	3	84
Hanomag	536 905 265	1 E 25	F 221 LEL. LNL	3	84





1 Front Axle 2 Driven or Pusher Axle
3 Rear or Driven Axle 4 Tag Axle L Lift Axle



OE	OE #	PHX			
Hanomag	536 905 265	1 E 25	F 223 LNL	3	84
Hanomag	536 905 265	1 E 25	F 76 LL	3	84
Hanomag	536 905 265	1 E 25	F 77 LL	3	84
Hanomag	546 905 134	1 E 21	F 76	3	80
Hendrickson	H 505431	1 D 23 G-1		3	19
Hendrickson	HS505431-03	1 D 23 G-1		3	19
IVECO	41270462	1 DF 20 G-1	Stralis rear axle front left	3	39
IVECO	41270463	1 DF 20 G-2	Stralis rear axle front right	3	40
IVECO	41270465	1 DF 20 G-3	Stralis rear axle rear left	3	40
IVECO	41270466	1 DF 20 G-4	Stralis rear axle rear right	3	41
IVECO	42559765	1 DF 20 G-1 NP	Stralis rear axle front left	3	39
IVECO	42559766	1 DF 20 G-2 NP	Stralis rear axle front right	3	40
IVECO	42559767	1 DF 20 G-3 NP	Stralis rear axle rear left	3	41
IVECO	42559768	1 DF 20 G-4 NP	Stralis rear axle rear right	3	41
IVECO	4714025	1 E 21-6		3	82
IVECO	4716989	1 E 21 C		3	81
IVECO	4738008	1 E 21-6		3	82
IVECO	4746733	1 E 25	FIAT - 116.121	1,3	84
IVECO	4746733	1 E 25	FIAT - 79.121	1,3	84
IVECO	4746733	1 E 25	IVECO - 190.30	1,3	84
IVECO	4746733	1 E 25	IVECO - 240.30	1,3	84
IVECO	4746733	1 E 25	IVECO - 240.36	1,3	84
IVECO	4746733	1 E 25	IVECO - 240.38	1,3	84
IVECO	500042581	1 DF 20 G-3	Stralis rear axle rear left	3	40
IVECO	500042582	1 DF 20 G-4	Stralis rear axle rear right	3	41
IVECO	500042583	1 DF 20 G-1	Stralis rear axle front left	3	39
IVECO	500042584	1 DF 20 G-2	Stralis rear axle front right	3	40
IVECO	500042598	1 DF 20 G-2 NP	Stralis rear axle front right	3	40
IVECO	500042599	1 DF 20 G-3 NP	Stralis rear axle rear left	3	41
IVECO	500042600	1 DF 20 G-1 NP	Stralis rear axle front left	3	39
IVECO	500042602	1 DF 20 G-4 NP	Stralis rear axle rear right	3	41
IVECO	5003 64686	1 E 21 E	Eurotech. Eurostar		82
IVECO	8188526	1 E 21-6	Eurotech		82
IVECO	8188539	1 F 20 A	Eurotech MP/LP 180 E	3	89
IVECO	8188539	1 F 20 A	Eurotech MP/LP 190 E	3	89
IVECO	8188539	1 F 20 A	Eurotech MP/LP 240 E	3	89
IVECO	8188539	1 F 20 A	Eurotech MP/LP 260 E	3	89
IVECO	8188539	1 F 20 A	Eurotech MP/LP 400 E	3	89
IVECO	8188539	1 F 20 A	Eurotech MP/LP 440 E	3	89
IVECO	98478799	1 F 20 B		3	89
Magirus-Deutz	0249 1566	1 F 21 A		3,4	92
Magirus-Deutz	0249 8667	1 E 25		3	84





1 Front Axle 2 Driven or Pusher Axle
3 Rear or Driven Axle 4 Tag Axle L Lift Axle

OE	OE #	PHX			
Magirus-Deutz	0249 8667	1 E 25	M 170 SH 110	1,3	84
Magirus-Deutz	0249 8667	1 E 25	M 200 L 120	1,3	84
Magirus-Deutz	0249 8667	1 E 25	M 200 SH 110	1,3	84
Magirus-Deutz	0249 8667	1 E 25	M 200 SH110-U	1,3	84
Magirus-Deutz	0249 8667	1 E 25	M 230 L 117	1,3	84
Magirus-Deutz	0249 8667	1 E 25	M 230 SH 117	1,3	84
Magirus-Deutz	0249 8667	1 E 25	R 121	1,3	84
Magirus-Deutz	0342 2571	2 B 20 R	150 L 10	1	100
Magirus-Deutz	0342 2571	2 B 20 R	Saturn II/II L	1	100
Magirus-Deutz	0418 22247	1 E 25	SH 110	1,3	84
Magirus-Deutz	0418 22247	1 E 25	SH 120	1,3	84
Magirus-Deutz	0418 22247	1 E 25	SH 170 (GL.B.)	1,3	84
Magirus-Deutz	0418 22247	1 E 25	U 80	1	84
Magirus-Deutz	536 905 265	1 E 21	R 105	1,3	80
MAN	81.43600.6035	1 DF 19 B-1	TGA ALV 11.56.3	3,4	32
MAN	81.43600.6035	1 DF 19 B-1	TGS	3,4	32
MAN	81.43600.6036	1 DF 16-2	TGA / TGX	3	29
MAN	81.43600.6055	1 DF 19 B-1		3,4	32
MAN	81.43600.6056	1 DF 16-2	TGS	3	29
MAN	81.43600.6078	1 DF 19 B-1		3,4	32
MAN	81.43600.6079	1 DF 16-2		3	29
MAN	81.43601.0033	1 F 21	13 168 FL/S/BL	3	91
MAN	81.43601.0033	1 F 21	BG 120 N	1,3	91
MAN	81.43601.0036	1 F 21	13 192 F-OC	1,3	91
MAN	81.43601.0037	1 F 21	13 192 FL	3	91
MAN	81.43601.0037	1 F 21	13 192 H-OC	1,3	91
MAN	81.43601.0037	1 F 21	14 168 FL/S/BL	3	91
MAN	81.43601.0037	1 F 21	14 192 FL/S/BL	3	91
MAN	81.43601.0037	1 F 21	14 192 UL/BL	3	91
MAN	81.43601.0037	1 F 21	15 168 FL/S/BL	3	91
MAN	81.43601.0037	1 F 21	15 192 FL/S/BL	3	91
MAN	81.43601.0037	1 F 21	15 240 FLS/BL	3	91
MAN	81.43601.0037	1 F 21	16 168 FL/S/BL	3	91
MAN	81.43601.0037	1 F 21	16 192 FL/S/BL	3	91
MAN	81.43601.0037	1 F 21	16 240 FL/S/BL	3	91
MAN	81.43601.0037	1 F 21	16 256 FL	1,3	91
MAN	81.43601.0037	1 F 21	16 256 FLS	3	91
MAN	81.43601.0037	1 F 21	16 320 FL/UL	1,3	91
MAN	81.43601.0037	1 F 21	16 320 FLS	1,3	91
MAN	81.43601.0037	1 F 21	16290 FL/FLS	1,3	91
MAN	81.43601.0037	1 F 21	19 240 FLS/BL	3	91
MAN	81.43601.0037	1 F 21	19 240 FLW/LL	3	91



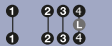

1 Front Axle 2 Driven or Pusher Axle
3 Rear or Driven Axle 4 Tag Axle L Lift Axle

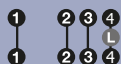

OE	OE #	PHX			
MAN	81.43601.0037	1 F 21	19 281 FLS/BL	3	91
MAN	81.43601.0037	1 F 21	19 281 FLW/LL	3	91
MAN	81.43601.0037	1 F 21	19 321 FLS/BL	3	91
MAN	81.43601.0037	1 F 21	19 321 FLW/LL	3	91
MAN	81.43601.0037	1 F 21	19 321 UU/LL	3	91
MAN	81.43601.0037	1 F 21	20 281 FVLS/BL	4	91
MAN	81.43601.0037	1 F 21	20 320 FVLS	4	91
MAN	81.43601.0037	1 F 21	20 321 FVLS/BL	4	91
MAN	81.43601.0037	1 F 21	22 192 FNFNL/BL	3	91
MAN	81.43601.0037	1 F 21	22 192 FNL/W/LL	3	91
MAN	81.43601.0037	1 F 21	22 192 FVL-KO	3	91
MAN	81.43601.0037	1 F 21	22 240 FNL/BL/LL	3	91
MAN	81.43601.0037	1 F 21	22 240 FNLW/LL	3	91
MAN	81.43601.0037	1 F 21	22 240 FVL-KO	3	91
MAN	81.43601.0037	1 F 21	22 281 FNL/BL/LL	3	91
MAN	81.43601.0037	1 F 21	22 281 FNLS/BL	3	91
MAN	81.43601.0037	1 F 21	22 281 FNLW/LL	3	91
MAN	81.43601.0037	1 F 21	22 281 FVLS/BL	3	91
MAN	81.43601.0037	1 F 21	22 320 FNL/LG.	3,4	91
MAN	81.43601.0037	1 F 21	22 320 UNL/LG.	3,4	91
MAN	81.43601.0037	1 F 21	22 321 FNL/BL/LL	3	91
MAN	81.43601.0037	1 F 21	22 321 FNLS/BL	3	91
MAN	81.43601.0037	1 F 21	22 321 FNLW/LL	3	91
MAN	81.43601.0037	1 F 21	22 321 FVLS/BL	3	91
MAN	81.43601.0037	1 F 21	22 321 UNL/BL/LL	3	91
MAN	81.43601.0037	1 F 21	26 320 DFLS	3,4	91
MAN	81.43601.0037	1 F 21	26 321 DFLS/BL	3,4	91
MAN	81.43601.0037	1 F 21	BG 120 N	1,3	91
MAN	81.43601.0039	1 F 26 B-1			93
MAN	81.43601.0040	1 F 26 B-1			93
MAN	81.43601.0051	1 E 32		1	88
MAN	81.43601.0065	1 F 16	10.150	3	89
MAN	81.43601.0066	1 F 20 A	14 232	3	89
MAN	81.43601.0067	1 F 16	F 90. F2000		89
MAN	81.43601.0068	1 F 20 A	15 168 FL/BL	3	89
MAN	81.43601.0069	1 F 20 A	15 200/40 FL	3	89
MAN	81.43601.0070	1 F 16	F 90. F2000		89
MAN	81.43601.0071	1 F 21 C-2	F 90	1	92
MAN	81.43601.0072	1 F 21 C-2			92
MAN	81.43601.0079	1 F 32 A	SD 242	3	94
MAN	81.43601.0082	1 F 32 A	SG 242/282	3	94
MAN	81.43601.0084	1 F 32 A	SG 242/292	1	94



1 Front Axle 2 Driven or Pusher Axle
3 Rear or Driven Axle 4 Tag Axle L Lift Axle

OE	OE #	PHX			
MAN	81.43601.0091	1 F 32 A	SG 242/292 F	1	94
MAN	81.43601.0092	1 F 16	F 90. F2000		89
MAN	81.43601.0099	1 F 16	F 90. F2000		89
MAN	81.43601.0103	1 F 16	F 90. F2000		89
MAN	81.43601.0104	1 F 20 B		1	89
MAN	81.43601.0106	1 F 20 A	15 240 FL/BL	3	89
MAN	81.43601.0109	1 F 20 B		1,3	89
MAN	81.43601.0110	1 F 21 C-2			92
MAN	81.43601.0111	1 F 20 B	18 310	1,3	89
MAN	81.43601.0114	1 F 32 A	SG 292 F Israel	1	94
MAN	81.43601.0116	1 F 32 A	SL 200	4	94
MAN	81.43601.0116	1 F 32 A	SL 200 F Israel	1,3	94
MAN	81.43601.0116	1 F 32 A	SL 200 F Portugal	3	94
MAN	81.43601.0116	1 F 32 A	SL 202 /F	3	94
MAN	81.43601.0116	1 F 32 A	SL 242 M 11 FLPG	1	94
MAN	81.43601.0116	1 F 32 A	SR 292/362	1	94
MAN	81.43601.0116	1 F 32 A	SUE 242	1	94
MAN	81.43601.0116	1 F 32 A	SUE 290 F Israel	3	94
MAN	81.43601.0121	1 F 16	F 90. F2000		89
MAN	81.43601.0123	1 F 20 B	18 313	1,3	89
MAN	81.43601.0125	1 F 20 B	F2000 (24 232)	1	89
MAN	81.43601.0125	1 F 20 B	FL (24 232)	1	89
MAN	81.43601.0125	1 F 20 B	FLAS (24 232)	1	89
MAN	81.43601.0125	1 F 20 B	FLL (24 232)	1	89
MAN	81.43601.0125	1 F 20 B	FLLS (24 232)	1	89
MAN	81.43601.0125	1 F 20 B	FLS (24 232)	1	89
MAN	81.43601.0128	1 F 21 C-2			92
MAN	81.43601.0132	1 F 16	F 90. F2000		89
MAN	81.43601.0137	1 F 21 C-2			92
MAN	81.43601.0140	1 F 20 B	F2000 (24 272)	4	89
MAN	81.43601.0140	1 F 20 B	FNL (24 272)	4	89
MAN	81.43601.0140	1 F 20 B	FNLL (24 272)	4	89
MAN	81.43601.0150	1 F 20 B	24 372	4	89
MAN	81.43601.0151	1 DF 16-2 NP	TGA	3	29
MAN	81.43601.0152	1 DF 19 B-1 NP	TGA ALV 11.5/6.3. ALV 13/6.5	3,4	33
MAN	81.43601.0163	1 E 25 B		1	85
MAN	81.43601.0174	1 DF 19 B-1 NP		3,4	33
MAN	81.43601.0175	1 DF 19 B-1 NP		3,4	33
MAN	81.43601.0180	1 DF 19 B-1 NP			33
MAN	81.43601.0181	1 DF 16-2 NP			29
MAN	88.96420.0217	2 B 20 R			100
Mercedes		1 KF 32-23 NP		3	99

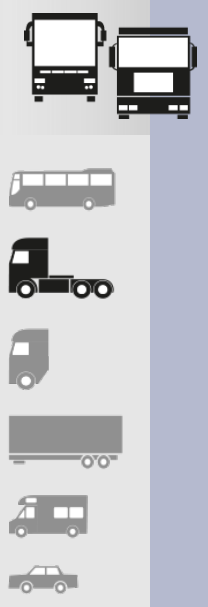

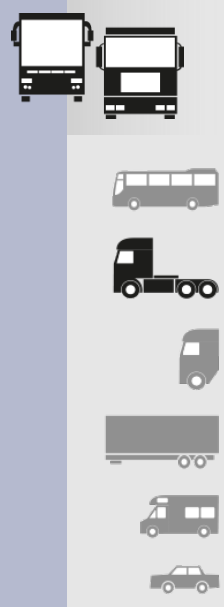

1 Front Axle 2 Driven or Pusher Axle
3 Rear or Driven Axle 4 Tag Axle L Lift Axle



OE	OE #	PHX			
Mercedes		1 KF 32-23 NP	Actros MP2 Service Assy.	3	99
Mercedes	363 328 02 01	1 F 26 C			94
Mercedes	383 327 00 01	1 F 21 A			92
Mercedes	387 328 01 01	1 F 21			91
Mercedes	393 328 01 01	1 F 26			93
Mercedes	674 328 00 01	1 F 26 D			94
Mercedes	942 320 01 17	1 KF 24-1			97
Mercedes	942 320 01 21	1 KF 21-1			95
Mercedes	942 320 02 21	1 KF 21-2			96
Mercedes	942 320 13 21	1 KF 32-23			99
Mercedes	942 320 14 21	1 KF 32-23			99
Mercedes	942 320 22 21	1 KF 32-23			99
Mercedes	942 320 23 21	1 KF 32-23			99
Mercedes	942 320 28 21	1 KF 21-21			96
Mercedes	942 320 29 21	1 KF 21-22			97
Mercedes	942 320 32 21	1 KF 24-29			98
Mercedes	942 320 43 21	1 KF 24-21			98
Mercedes	942 320 49 21	1 KF 21-21			96
Mercedes	942 320 50 21	1 KF 21-22			97
Mercedes	942 327 00 01	1 KF 24-1 NP			97
Mercedes	942 327 06 01	SP 2 B 12 R-17			109
Mercedes	942 328 00 01	1 KF 21-1 NP			95
Mercedes	942 328 01 01	1 KF 21-2 NP			96
Mercedes	960 320 00 57	1 DF 16 A-1			28
Mercedes	960 320 01 57	1 DF 16 A-2			29
Mercedes	960 320 67 57	1 DF 16 A-1			28
Mercedes	960 320 68 57	1 DF 16 A-2			29
Mercedes	960 320 70 21	1 DF 16 A-1			28
Mercedes	960 320 77 21	1 DF 16 A-2			29
Mercedes	974 320 02 17	1 KF 24-9			99
Mercedes	974 320 04 17	1 KF 24-9			99
Mercedes	974 328 00 01	1 KF 24-2 NP			98
Mercedes	974 328 01 01	1 KF 24-2 NP			98
Mercedes	A 363 328 02 01	1 F 26 C			94
Mercedes	A 383 327 00 01	1 F 21 A	2028 LS		92
Mercedes	A 387 328 01 01	1 F 21	1071 LS		91
Mercedes	A 387 328 01 01	1 F 21	1217 L		91
Mercedes	A 387 328 01 01	1 F 21	1419 L		91
Mercedes	A 387 328 01 01	1 F 21	1420 L		91
Mercedes	A 387 328 01 01	1 F 21	1422 L/LS		91
Mercedes	A 387 328 01 01	1 F 21	1425 LS		91
Mercedes	A 387 328 01 01	1 F 21	1524 LS		91



1 Front Axle 2 Driven or Pusher Axle
3 Rear or Driven Axle 4 Tag Axle L Lift Axle

OE	OE #	PHX			
Mercedes	A 387 328 01 01	1 F 21	1613 L		91
Mercedes	A 387 328 01 01	1 F 21	1617 L		91
Mercedes	A 387 328 01 01	1 F 21	1620 L		91
Mercedes	A 387 328 01 01	1 F 21	1622 L		91
Mercedes	A 387 328 01 01	1 F 21	1624 L/LS		91
Mercedes	A 387 328 01 01	1 F 21	1625 L/LS		91
Mercedes	A 387 328 01 01	1 F 21	1626 L/LS		91
Mercedes	A 387 328 01 01	1 F 21	1628 L		91
Mercedes	A 387 328 01 01	1 F 21	1632 L/LS		91
Mercedes	A 387 328 01 01	1 F 21	1633 L		91
Mercedes	A 387 328 01 01	1 F 21	1635 L		91
Mercedes	A 387 328 01 01	1 F 21	1928 L		91
Mercedes	A 387 328 01 01	1 F 21	1932 LS		91
Mercedes	A 387 328 01 01	1 F 21	2219 L/LPL		91
Mercedes	A 387 328 01 01	1 F 21	2220 L		91
Mercedes	A 387 328 01 01	1 F 21	2222 L		91
Mercedes	A 387 328 01 01	1 F 21	2224 LS		91
Mercedes	A 387 328 01 01	1 F 21	2226 L		91
Mercedes	A 387 328 01 01	1 F 21	2228 L		91
Mercedes	A 387 328 01 01	1 F 21	2232 L		91
Mercedes	A 387 328 01 01	1 F 21	2232 LPL		91
Mercedes	A 387 328 01 01	1 F 21	2233 L		91
Mercedes	A 387 328 01 01	1 F 21	2235 L		91
Mercedes	A 387 328 01 01	1 F 21	2238 L		91
Mercedes	A 387 328 01 01	1 F 21	2244 L		91
Mercedes	A 387 328 01 01	1 F 21	2252 L		91
Mercedes	A 387 328 01 01	1 F 21	2624 LS		91
Mercedes	A 387 328 01 01	1 F 21	709 LPL		91
Mercedes	A 387 328 01 01	1 F 21	808 LPL		91
Mercedes	A 387 328 01 01	1 F 21	809 LPL		91
Mercedes	A 387 328 01 01	1 F 21	813 LPL		91
Mercedes	A 387 328 01 01	1 F 21	813 LPS/LPLS		91
Mercedes	A 393 328 01 01	1 F 26			93
Mercedes	A 674 328 00 01	1 F 26 D			94
Mercedes	A 942 320 01 17	1 KF 24-1	Actros	1	97
Mercedes	A 942 320 01 21	1 KF 21-1	Actros	3	95
Mercedes	A 942 320 02 21	1 KF 21-2	Actros	3	96
Mercedes	A 942 320 13 21	1 KF 32-23	Actros	3	99
Mercedes	A 942 320 14 21	1 KF 32-23	Actros	3	99
Mercedes	A 942 320 22 21	1 KF 32-23	Actros MP2	3	99
Mercedes	A 942 320 23 21	1 KF 32-23	Actros MP2	3	99
Mercedes	A 942 320 28 21	1 KF 21-21	Actros MP2	3	96

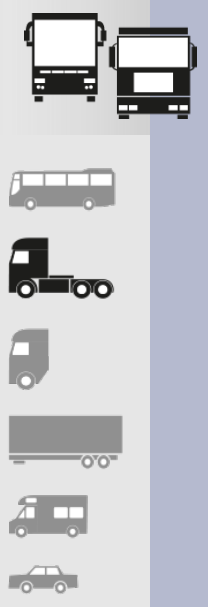

1 Front Axle 2 Driven or Pusher Axle
3 Rear or Driven Axle 4 Tag Axle L Lift Axle

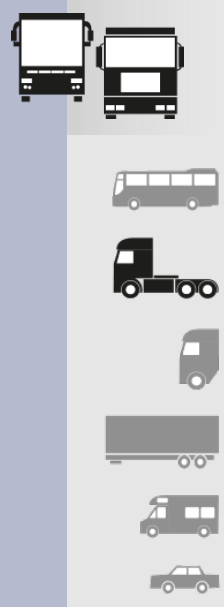

OE	OE #	PHX			
Mercedes	A 942 320 29 21	1 KF 21-22	Actros MP2	3	97
Mercedes	A 942 320 32 21	1 KF 24-29	Actros, Atego	3	98
Mercedes	A 942 320 43 21	1 KF 24-21	Actros	3	98
Mercedes	A 942 320 49 21	1 KF 21-21	Actros	3	96
Mercedes	A 942 320 50 21	1 KF 21-22	Actros	3	97
Mercedes	A 942 327 00 01	1 KF 24-1 NP	Actros	3	97
Mercedes	A 942 327 06 01	SP 2 B 12 R-17	Hendrickson MLA1	2	109
Mercedes	A 942 328 00 01	1 KF 21-1 NP	Actros	3	95
Mercedes	A 942 328 01 01	1 KF 21-2 NP	Actros	3	96
Mercedes	A 960 320 00 57	1 DF 16 A-1	Actros MP4	3	28
Mercedes	A 960 320 01 57	1 DF 16 A-2	Actros MP4	3	29
Mercedes	A 960 320 67 57	1 DF 16 A-1	Actros MP4	3	28
Mercedes	A 960 320 68 57	1 DF 16 A-2	Actros MP4	3	29
Mercedes	A 960 320 70 21	1 DF 16 A-1	Actros MP4	3	28
Mercedes	A 960 320 77 21	1 DF 16 A-2	Actros MP4	3	29
Mercedes	A 974 320 02 17	1 KF 24-9	Actros, Atego	3	99
Mercedes	A 974 320 04 17	1 KF 24-9	Actros, Atego	3	99
Mercedes	A 974 328 00 01	1 KF 24-2 NP	Atego	3	98
Mercedes	A 974 328 01 01	1 KF 24-2 NP	Atego	3	98
Pegaso	175005	1 D 28 B-2	Troner	4	22
Renault	21 978 494	1 DK 28 F-6	Premium / Magnum standard	3	73
Renault	22 190 563	1 DK 19-1	Premium / Magnum tag	4	54
Renault	5.000.452.939	1 D 28 A-2		3	20
Renault	5.000.790.692	1 D 28 B-2		3	22
Renault	5.010.130.925	1 D 28 B-2			22
Renault	5.010.239.252	1 DK 23 F-1	Premium. Magnum	1	67
Renault	5.010.294.307	1 DK 28 F-4	Magnum / Premium	3	72
Renault	5.010.294.309	1 DK 19-1	Premium / Magnum tag	4	54
Renault	5.010.294.309	1 DK 19-1	Premium / Magnum tag	4	54
Renault	5.010.488.070	1 DK 19-1		4	54
Renault	5.010.488.071	1 DK 23 F-1	Premium. Magnum	1	67
Renault	5.010.557.355	1 DK 28 F-5	Midlum 18t	3	73
Renault	5.010.557.355	1 DK 28 F-5	Premium / Magnum standard	3	73
Renault	5.010.600.328	1 DK 28 F-6	Premium / Magnum standard	3	73
Renault	7.422.190.563	1 DK 19-1	Premium / Magnum tag	4	54
Sachs	00 1748 451 100	1 E 25 B		1	85
Scania		1 E 18	BF 86/110/111		78
Scania		1 E 18	BR CR 110		78
Scania		1 E 18	BR/CR 111/111 DH		78
Scania		1 E 18	BR/CR 112		78
Scania		1 E 18	BR/CR 116		78
Scania		1 E 18	BR/CR 145		78





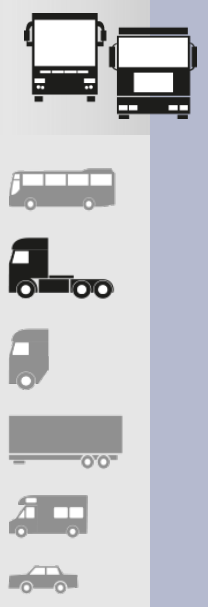

1 Front Axle 2 Driven or Pusher Axle
3 Rear or Driven Axle 4 Tag Axle L Lift Axle

OE	OE #	PHX			
Scania		1 E 18	CR 76		78
Scania		1 E 21 C	BF 86/110/111		81
Scania		1 E 21 C	BR CR 110		81
Scania		1 E 21 C	BR/CR 111/111 DH		81
Scania		1 E 21 C	BR/CR 112		81
Scania		1 E 21 C	BR/CR 116		81
Scania		1 E 21 C	BR/CR 145		81
Scania		1 E 21 C	CR 76		81
Scania	1107674	1 D 28 B-9	Series 3	3	23
Scania	1314903	1 DK 18 A-1		2,L	54
Scania	1314905	1 DK 23 L-31	3-Series STD	2,L	70
Scania	1314906	1 D 28 B-9	Series 3	3	23
Scania	1319761	SP 2 B 12 R-5		L	109
Scania	1362145	1 DF 23 C-1	Series 4	1	45
Scania	1362147	1 DF 23 D-1	Series 4	1	46
Scania	1370743	1 DF 23 C-1		1	45
Scania	1370744	1 DF 23 D-1		1	46
Scania	1379392	1 D 28 H-16	Series 4	3	27
Scania	1379393	1 D 28 H-16 NP	Series 4	3	27
Scania	1386198	1 DF 23 B-3	P,R,T-Series X-LOW	1	44
Scania	1386199	1 DF 23 C-1	P,R,T-Series SPECIAL	1	45
Scania	1386200	1 DF 23 D-1	P,R,T-Series STD	1	46
Scania	1387289	SP 2 B 12 R-5		L	109
Scania	1394997	1 DK 18 A-1		2,L	54
Scania	1402423	1 DK 18 A-1		2,L	54
Scania	1434930	1 DF 17 B-2	Scania	3	31
Scania	1434933	1 DF 23 G-1	Scania P,R,T	3	46
Scania	1440294	1 D 28 H-16	Series 4	3	27
Scania	1543691	1 D 28 H-16	R-Series new generation	3	27
Scania	1723269	1 D 28 B-2			22
Scania	1723273	1 DK 22 E-8			66
Scania	1723275	1 D 28 A-10			19
Scania	1723276	1 D 28 B-11			22
Scania	1723277	1 DK 22 E-9			66
Scania	1723280	1 D 28 B-10			21
Scania	1723281	1 DK 22 E-11			63
Scania	1723502	1 D 28 A-2			20
Scania	1723523	SP 2 B 12 R-5			109
Scania	1774804	1 D 28 H-17	Scania P,R,T	3,4	28
Scania	1865753	1 DK 23 L-31	4-Series STD	2,L	70
Scania	1865755	1 D 28 B-9	Series 3	3	23
Scania	1865759	1 DK 18 A-1	Scania P,R,T	2,L	54

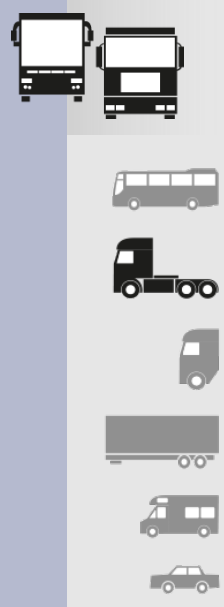



1 Front Axle 2 Driven or Pusher Axle
3 Rear or Driven Axle 4 Tag Axle L Lift Axle



OE	OE #	PHX			
Scania	1873856	1 D 28 C-12			24
Scania	1873863	1 D 28 B-11			22
Scania	1903608	1 D 28 H-17	Scania P,R,T	3,4	28
Scania	1932592	1 DF 17 B-2	Scania P,R,T	3	31
Scania	1932593	1 DF 23 G-1	Scania P,R,T	3	46
Scania	1942148	1 DF 23 C-2	P,R,T-Series LOW	1	46
Scania	1944314	1 D 28 H-17	R-Series new generation	3	28
Scania	2198324	1 D 28 F-5			26
Scania	2198328	1 DK 28 F-3			72
Scania	2198330	1 DK 32-2	36		76
Scania	2198331	1 DK 32 K-2			75
Scania	2198333	1 DK 20 A-1			54
Scania	2198334	1 DK 20 B-1			55
Scania	2198335	1 D 28 F-1			26
Scania	2198483	1 DK 21 K-2	30 K		60
Scania	2198915	1 D 28 H-17	Scania P,R,T	3,4	28
Scania	2338883	1 DK 32	36		74
Scania	2338887	1 DK 21-2	30		62
Scania	2357460	1 D 28 H-17		3,4	28
Scania	2357532	1 D 28 H-17	Scania P,R,T	3,4	28
Scania	2406164	1 DK 21 K	30 K		60
Scania	255293	1 D 28 B-9	Series 3	3	23
Scania	2617884	1 DF 17 B-2		3	31
Scania	2808412	1 D 28 H-17		3	28
Scania	298568	1 D 28 B-9	Series 3	3	23
Scania	325748	1 D 28 B-9	Series 3	3	23
Volvo	1 075 890	1 DF 20 D-1	FH standard	3	37
Volvo	1 075 891	1 DF 17 B-1	FH 12	3	30
Volvo	1 076 415	1 DF 20 D-1	FH 12	3	37
Volvo	1 076 416	1 DF 17 B-1	FH 12	3	30
Volvo	1 076 417	1 DF 20 E-1		3	38
Volvo	1 076 418	1 DF 17 A-1	FH medium	3	30
Volvo	1 076 594	1 DF 22 C-1	NH12/FH12		42
Volvo	1 076 595	1 DF 22 C-1 NP		3	42
Volvo	1 080 707	1 D 28 A-2			20
Volvo	1 082 085	1 F 21 C-2			92
Volvo	1 593 842	1 F 26 B-1	FL 7/10	1	93
Volvo	1 611 776	1 F 21 A			92
Volvo	1 622 115	1 F 21			91
Volvo	1 622 116	1 F 21 D	FH 10 / FH 12		93
Volvo	1 629 193	1 F 21	F...	3	91
Volvo	10 764 417	1 DF 20 E-1		3	38









1 Front Axle 2 Driven or Pusher Axle
3 Rear or Driven Axle 4 Tag Axle L Lift Axle

OE	OE #	PHX			
Volvo	20 374 510	1 DF 17 B-1	FH 12	3	30
Volvo	20 374 511	1 DF 17 A-1	FH 12 medium	3	30
Volvo	20 374 512	1 DF 17 C-1		3	32
Volvo	20 375 226	1 DF 20 D-1	FH standard	3	37
Volvo	20 375 227	1 DF 20 E-1	FH 12 medium	3	38
Volvo	20 427 800	1 DF 20 D-1	FH standard	3	37
Volvo	20 427 801	1 DF 20 E-1	FH 12 medium	3	38
Volvo	20 456 150	1 DF 20 D-1	FH standard	3	37
Volvo	20 456 152	1 DF 17 B-1	FH 12	3	30
Volvo	20 456 154	1 DF 20 E-1	FH 12 medium	3	38
Volvo	20 456 156	1 DF 17 A-1	FH 12 medium	3	30
Volvo	20 456 160	1 DF 17 C-1		3	32
Volvo	20 531 984	1 DF 20 D-1	FH standard	3	37
Volvo	20 531 985	1 DF 17 B-1	FH 12	3	30
Volvo	20 531 986	1 DF 20 E-1	FH 12 medium	3	38
Volvo	20 531 987	1 DF 17 A-1	FH 12 medium	3	30
Volvo	20 531 989	1 DF 17 C-1		3	32
Volvo	20 541 504	SP 2 B 12 R-B-1	FM / FH	L	110
Volvo	20 554 755	1 DF 22 C-1		3	42
Volvo	20 582 206	1 DF 20 D-1	FM / FH standard	3	37
Volvo	20 582 209	1 DF 20 E-1	FM / FH medium	3	38
Volvo	20 582 213	1 DF 17 C-1	FM / FH low	3	32
Volvo	20 582 214	1 DF 17 A-1	FM / FH medium	3	30
Volvo	20 582 215	1 DF 17 B-1	FM / FH standard	3	30
Volvo	20 722 412	1 DK 28 F-5	FM / FH Standard	3	73
Volvo	20 726 768	1 DK 28 F-6	FM / FH Standard	3	73
Volvo	20 909 152	1 DF 20 E-2	FH medium	2	38
Volvo	21 224 745	1 DF 20 D-2	Volvo FM / FH	3	38
Volvo	21 224 746	1 DF 20 F-1	Volvo FM / FH	3	39
Volvo	21 224 750	1 DF 17 A-2	FM / FH medium	3	30
Volvo	21 961 374	1 DF 20 D-1	FM / FH standard	3	37
Volvo	21 961 448	1 DF 17 C-1	FM / FH low	3	32
Volvo	21 961 456	1 DF 17 B-1	FM / FH standard	3	30
Volvo	21 977 974	1 DF 20 E-2	FH medium	2	38
Volvo	21 978 504	1 DK 28 F-6	FM / FH Standard	3	73
Volvo	22 025 613	1 DK 19-1	FM / FH	4	54
Volvo	22 056 630	1 DF 17 A-2	FM / FH medium	3	30
Volvo	22 058 737	1 DF 20 D-2	Volvo FM / FH	3	38
Volvo	22 058 738	1 DF 20 F-1	Volvo FM / FH	3	39
Volvo	22 058 741	1 DF 17 B-4	FM / FH std/high	3	31
Volvo	22 573 233	SP 2 B 12 R-B-1	FM / FH	L	110
Volvo	25 372 795	1 DK 28 F-6	FM / FH standard	3	73





1 Front Axle 2 Driven or Pusher Axle
3 Rear or Driven Axle 4 Tag Axle L Lift Axle



OE	OE #	PHX		   	 
Volvo	3 171 694	1 DF 20 E-1	FH medium	3	38
Volvo	3 171 695	1 DF 17 A-1	FH medium	3	30
Volvo	6 797 169	1 F 21 D	F 10/12		93
Volvo	6 797 169	1 F 21 D	FH 10/12		93





1 Front Axle 2 Driven or Pusher Axle
3 Rear or Driven Axle 4 Tag Axle L Lift Axle

OE	OE #	PHX			
Renault	5.010.130.797.G	C 075 185	Premium		105
Renault	5.010.491.301	2 C 91-10	Magnum		102
Renault	5.010.629.414	C 075 185	Premium		105
Volvo	20 906 196	C 075 185	Premium	2	105





1 Front
2 Rear



OE	OE #	PHX			
Acerbi	128140028	1 DK 20 A-51			55
Acerbi	800449526	1 DK 20 A-51			55
Bartoletti	91619005	1 DK 28 B-7			71
Bartoletti	91619011	1 DK 28 B-7			71
Bevola	052360	1 DK 22 D-1	BevoFlex CS9I		63
Bevola	052361	1 DK 22 D-2	BevoFlex CS9I		63
BPW	02.200.20.50.0	2 B 20 R			100
BPW	02.200.24.00.0	1 F 32 B			95
BPW	02.200.24.10.0	1 F 21			91
BPW	02.200.24.40.0	1 E 21			80
BPW	02.200.24.60.0	1 E 32			88
BPW	05.429.40.01.0	1 DK 32	36		74
BPW	05.429.40.03.0	1 DK 21	30		56
BPW	05.429.40.05.0	1 DK 32 L	36-1		75
BPW	05.429.40.91.0	1 DK 21 K	30 K		60
BPW	05.429.41.01.0	1 DK 32 K	36 K		74
BPW	05.429.41.23.1	1 DK 21 K-1	30 K		60
BPW	05.429.41.24.1	1 DK 21-1	30		62
BPW	05.429.41.31.1	1 DK 32 K-1	36 K		75
BPW	05.429.41.36.1	1 DK 32-1	36		76
BPW	05.429.41.69.0	1 DK 32 L-1	36-1		76
BPW	05.429.41.77.0	1 DK 21 K-3	30 K		61
BPW	05.429.43.20.0	1 DK 21-2	30		62
BPW	05.429.43.21.0	1 DK 21 K-2	30 K		60
BPW	05.429.43.23.0	1 DK 21 K-32	30 K		61
BPW	05.429.43.34.0	1 DK 21-1	30		62
BPW	05.429.43.37.0	1 DK 21 K-2	30 K		60
BPW	05.429.43.41.0	1 DK 32 K-2	36 K		75
BPW	05.429.43.44.0	1 DK 32 K-2	36 K		75
BPW	05.429.43.51.0	1 DK 32-2	36		76
BPW	05.429.43.56.0	1 DK 21-1	30		62
BPW	05.429.43.85.0	1 DK 21-4	30		62
BPW	05.429.43.86.0	1 DK 21 K-4	30 K		61
Cardi	58050315	2 E 23			103
Cardi	58050700	1 DK 28 B-7			71
Cardi	58050710	1 DK 28 B-7			71
Cardi	58050900	1 D 23 E-3			18
Cardi	58051000	1 DK 28 B-7			71
Cardi	58051210	1 DK 23 L-9131			71
Daimler TAS	946 328 14 01	1 DK 21 C-4			59
Daimler TAS	946 328 15 01	1 DK 28 F-3			72
Daimler TAS	946 328 16 01	SP 2 B 12 R-A-10			109



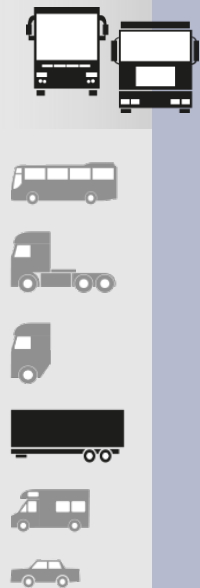

1 Front Axle 2 Mid Axle
3 Rear Axle L Lift Axle

OE	OE #	PHX			
Daimler TAS	946 328 19 01	1 D 28 A-13			20
Daimler TAS	946 328 22 01	1 DK 28 H-3			73
Daimler TAS	A 946 328 04 01	1 DK 25-1	HT250		71
Daimler TAS	A 946 328 14 01	1 DK 21 C-4	DCA; DLS		59
Daimler TAS	A 946 328 14 01	1 DK 21 C-4	DCA; DLS. TE5/8		59
Daimler TAS	A 946 328 15 01	1 DK 28 F-3	DCA; DLS. TE5/8		72
Daimler TAS	A 946 328 16 01	SP 2 B 12 R-A-10	DCA; DLS	L	109
Daimler TAS	A 946 328 19 01	1 D 28 A-13	DCA; DLS. TE5/8		20
Daimler TAS	A 946 328 22 01	1 DK 28 H-3	DCA Megamaster		73
Daimler TAS	A 946 328 25 01	1 DK 21 C-5			59
Floor	00848	1 E 32			88
Floor	00862	1 F 32 A			94
Floor	13586	SP 2 B 12 R		L	108
Fruehauf		1 DK 21 B-5 NP	Service Assembly		59
Fruehauf		1 DK 23 K-9082			68
Fruehauf		1 DK 23 L-27			70
Fruehauf	UJB 0203-001	1 DK 23 L-25			70
Fruehauf	UJB 0305	1 DK 28 D-3			72
Fruehauf	UJB 0305-001	1 D 28 C-12			24
Fruehauf	UJB 0358-001	1 DK 23 L-9131			71
Fruehauf	UJB 0975	1 DK 20 A-51			55
Fruehauf	UJB 1180/B	1 DK 20 C-2			56
Gigant	00190130	SP 2 B 12 R-1		L	108
Gigant	00190130	SP 2 B 12 R-16		L	108
Gigant	166205	1 F 32 B	NLRM / NLR Series		95
Gigant	166252	1 DF 32-1			53
Gigant	190130	SP 2 B 12 R-1		L	108
Gigant	196036	1 F 32 B	NLRM / NLR Series		95
Gigant	196043	1 F 32 A			94
Gigant	196071	SP 2 B 34 R			111
Gigant	196084	1 DK 20 C-5		3	56
Gigant	3653 compl.	1 DF 32-1			53
Gigant	700166205	1 F 32 B			95
Gigant	700166252	1 DF 32-1			53
Gigant	700190130	SP 2 B 12 R-1			108
Gigant	700196036	1 F 32 B			95
Gigant	700196043	1 F 32 A			94
Gigant	700196071	SP 2 B 34 R			111
Gigant	700196084	1 DK 20 C-5		3	56
Gigant	709377003	1 DK 20 C-5		3	56
Granning	1359	1 DK 23 K-9082			68
Granning	1528	1 DK 23 K-9082			68





1 Front Axle 2 Mid Axle
3 Rear Axle L Lift Axle



OE	OE #	PHX			
Granning	15599	SP 2 B 12 R-5			109
Granning	15603	SP 2 B 12 R		L	108
Granning	15634	1 D 28 B-2			22
Granning	15635	1 D 28 A-2			20
Granning	15670	SP 2 B 12 R-A-10		L	109
Granning	15923	2 B 20 R			100
Granning	2727	1 DK 23 K-9082			68
Hendrickson		1 DK 23 K-1 NP	Service Assembly		68
Hendrickson	505 859	1 D 28 B-2	Airpoise <86		22
Hendrickson	505 859 / 01	1 D 28 B-2	Tecair		22
Hendrickson	506 243	1 D 28 A-2	Tecair		20
Hendrickson	506 243 / 01	1 D 28 A-2	Tecair		20
Hendrickson	507 782	1 D 28 D-2			25
Hendrickson	785 168	1 D 28 A-2			20
Hendrickson	785 170	1 D 28 B-2			22
Hendrickson	B 2066	1 DK 23 K-9082	T - US		68
Hendrickson	HA100001	1 DK 23 K-1			67
Hendrickson	HS 251087	1 DK 25-1			71
Hendrickson	HS505613	SP 2 B 12 R-17	MLA1		109
Hüffermann	1613400	1 DK 21 A-9			58
Hüffermann	6-AB8003-0100	1 DK 32-2	36		76
Hüffermann	6-AB8003-0200	1 DK 32 K-2	36 K		75
Hüffermann	6-AB8003-0300	1 DK 32 L-1	36-1		76
Jost	20 105 015 01	1 DK 28 F-3			72
Jost	2010501901	1 D 28 A-13			20
Jost	30 105 014 01	1 DK 21 C-4			59
Jost	30 105 022 01	1 DK 28 H-3			73
Jost	3010502501	1 DK 21 C-5			59
Jost	JAE 20 105 015 01	1 DK 28 F-3			72
Jost	JAE 20 105 019 01	1 D 28 A-13			20
Jost	JAE 30 105 014 01	1 DK 21 C-4			59
Jost	JAE 30 105 022 01	1 DK 28 H-3			73
Jost	JAE 30 105 025 01	1 DK 21 C-5			59
Jost	JAS 20 105 015 01	1 DK 28 F-3			72
Jost	JAS 20 105 019 01	1 D 28 A-13			20
Jost	JAS 30 105 014 01	1 DK 21 C-4			59
Jost	JAS 30 105 022 01	1 DK 28 H-3			73
Jost	JAS 30 105 025 01	1 DK 21 C-5			59
Kaiser	A 06030620	1 D 28 G-26			26
Kässbohrer	4.731.003.000	2 B 20 R	SG 176		100
Kässbohrer	4.731.005.000	2 B 34 R			101
Kässbohrer	4.731.024.000	2 B 20 R			100



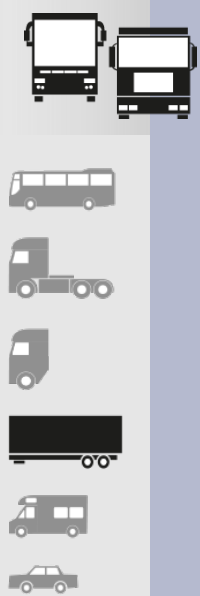

1 Front Axle 2 Mid Axle
3 Rear Axle L Lift Axle

OE	OE #	PHX			
Kässbohrer	4.731.025.000	2 B 49 R-B			102
Kässbohrer	4.731.030.000	1 D 28 B-2			22
Kässbohrer	4.731.032.000	1 F 32 B			95
Kässbohrer	4.731.033.000	1 D 28 B-2			22
Kässbohrer	4.731.034.100	2 B 34 R-B			101
Kässbohrer	4.731.034.200	2 B 34 R-B			101
Kässbohrer	4.731.035.100	2 B 49 R-A			102
Kässbohrer	4.731.035.200	2 B 49 R-A			102
Kässbohrer	4.731.036.000	2 B 20 R-9			101
Kässbohrer	4.731.043.000	1 DK 32 E-4			74
Kässbohrer	4.731.045.100	SP 2 B 22 R-1			111
Kässbohrer	4.731.045.300	SP 2 B 22 R-1			111
Kögel		1 E 21			80
Kögel		1 E 32			88
Kögel		1 F 32 A			94
Kögel	360112	1 DK 22 E-14			64
Kögel	6501706	SP 2 B 12 R-5		L	109
Kögel	6502824	SP 2 B 12 R-5		L	109
KRONE	09377003	1 DK 20 C-5		3	56
KRONE	515069174	1 DK 20 C-5		3	56
KRONE	550011095	SP 2 B 12 R-16		L	108
KRONE	550018054	SP 2 B 12 R-16		L	108
KRONE	550018680	SP 2 B 12 R		L	108
Leciñena		1 D 28 A-12			20
Leciñena	120025000199	1 D 28 A-13			20
Lecitrailer	SN21502	1 D 28 B-4			23
Meritor		1 D 28 A-10 NP			19
Meritor		1 D 28 A-5 NP			21
Meritor		1 D 28 B-5 NP			23
Meritor		1 DK 21 A-4 NP			58
Meritor		1 DK 23 K-1 NP			68
Meritor	2120 8082	1 D 28 A-2			20
Meritor	2120 8939	1 DK 23 K-9082			68
Meritor	2121 5632	1 D 28 A-2			20
Meritor	2121 5633	1 D 28 B-2			22
Meritor	2121 5761	1 DK 23 K-1			67
Meritor	2122 1307	1 DK 21 C-4			59
Meritor	2122 1349	1 D 28 C-12			24
Meritor	2122 1356	SP 2 B 12 R-A-10			109
Meritor	2122 1395	SP 2 B 12 R		L	108
Meritor	2122 2239	1 D 28 B-12			22
Meritor	2122 2442	1 DK 21 A-31			57





1 Front Axle 2 Mid Axle
3 Rear Axle L Lift Axle

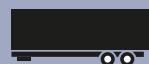

OE	OE #	PHX			
Meritor	2122 2663	SP 2 B 12 R		L	108
Meritor	2122 2673	1 D 28 D-2			25
Meritor	2122 9214	1 DK 22 D-1			63
Meritor	2123 0298	1 DK 22 E-17			65
Montenegro		1 DK 21 B-4			58
Neway	21215632	1 D 28 A-2			20
Neway	905 570 06	1 DK 23 K-9082			68
Neway	905 570 27	1 DK 23 K-9082	AR 120		68
Neway	905 570 27	1 DK 23 K-9082	AR 120.US		68
Neway	905 570 27	1 DK 23 K-9082	AR 75.9		68
Neway	905 570 27	1 DK 23 K-9082	Art 500		68
Neway	905 570 27	1 DK 23 K-9082	Art 505		68
Neway	905 570 33	1 DK 23 K-9082			68
Neway	905 570 37	1 DK 23 K-9082			68
Neway	905 570 54	1 DK 23 K-9082			68
Neway	905 570 75	1 DK 23 K-9082	AR - 1057		68
Neway	905 572 33	1 DK 20 C-2			56
Omar	11804	1 DK 28 B-7			71
Omar	11808	1 D 23 E-3			18
Paul NFZ	P2700MB0813	1 D 28 B-2			22
Rolfo	112060	1 DK 28 B-7			71
Rolfo	112064	1 DK 28 B-7			71
SAE	8403 / 102	1 D 28 B-2			22
SAF - Holland		1 D 28 A-10 NP	2918 V Service Assembly		19
SAF - Holland		1 D 28 A-5 NP	2918 Service Assembly		21
SAF - Holland		1 D 28 B-10 NP	2923 V Service Assembly		21
SAF - Holland		1 D 28 B-5 NP	2923 Service Assembly		23
SAF - Holland	1608	SP 2 B 12 R-A-3			110
SAF - Holland	2.228.0002.00	1 D 28 A-2	2918 AR 112-114. AR 200		20
SAF - Holland	2.228.2102.00	1 D 28 A-2	2918 AR 112-114. AR 200		20
SAF - Holland	2.228.2202.00	1 D 28 A-2	2918 AR 112-114. AR 200		20
SAF - Holland	2.228.2402.00	1 D 28 A-2	2918 AR 112-114. AR 200		20
SAF - Holland	2.228.2602.00	1 D 28 A-2	2918 AR 112-114. AR 200		20
SAF - Holland	2.229.0002.00	1 D 28 A-2	2918 N P02		20
SAF - Holland	2.229.0003.00	1 D 28 B-2	2923 AR 211-213. AR 413		22
SAF - Holland	2.229.0003.00	1 D 28 B-2	2923 R 112-113. R 142-143		22
SAF - Holland	2.229.0007.00	1 DK 22 E-5	2618 (E5)		65
SAF - Holland	2.229.0010.00	1 D 28 B-2			22
SAF - Holland	2.229.2103.00	1 D 28 B-2	2923 AR 211-213. AR 413		22
SAF - Holland	2.229.2403.00	1 D 28 B-2	2923 AR 211-213. AR 413		22
SAF - Holland	2.229.2603.00	1 D 28 B-2	2923 AR 211-213. AR 413		22
SAF - Holland	2618	1 DK 22 E-8			66



1 Front Axle 2 Mid Axle
3 Rear Axle L Lift Axle

OE	OE #	PHX			
SAF - Holland	2618(E5)	1 DK 22 E-5			65
SAF - Holland	2618IL	1 DK 22 E-15			64
SAF - Holland	2618V	1 DK 22 E-9			66
SAF - Holland	2619IL	1 DK 22 E-16			65
SAF - Holland	2619V	1 DK 22 E-11			63
SAF - Holland	2621V	1 DK 22 E-13			64
SAF - Holland	2626V	1 DK 22 E-14			64
SAF - Holland	2918V	1 D 28 A-10			19
SAF - Holland	2919V	1 D 28 E-2			25
SAF - Holland	2922V	1 D 28 E-1			25
SAF - Holland	2923	1 D 28 B-2			22
SAF - Holland	2923V	1 D 28 B-10			21
SAF - Holland	2923VK	1 D 28 B-11			22
SAF - Holland	2924V	1 D 28 B-11			22
SAF - Holland	2926	1 D 28 C-12			24
SAF - Holland	2926V	1 D 28 D-10			24
SAF - Holland	2927V	1 D 28 D-11			24
SAF - Holland	3.228.1043.00	1 DK 22 E-16	2619 IL		65
SAF - Holland	3.229.0007.00	1 DK 22 E-8	2618 AR 416		66
SAF - Holland	3.229.0007.02	1 DK 22 E-8	2618		66
SAF - Holland	3.229.0024.00	1 D 28 C-12	2926		24
SAF - Holland	3.229.0027.00	1 D 28 A-10	2918 V		19
SAF - Holland	3.229.0028.00	1 D 28 B-11	2923 VK		22
SAF - Holland	3.229.0029.00	1 DK 22 E-9	2618 V	3,L	66
SAF - Holland	3.229.0030.00	1 D 28 D-10	2926 V P01		24
SAF - Holland	3.229.0031.00	1 D 28 B-10	2923 V		21
SAF - Holland	3.229.0033.00	1 DK 22 E-11	2918 V P01	L	63
SAF - Holland	3.229.0036.00	1 D 28 E-1	2922 V		25
SAF - Holland	3.229.0038.00	1 DK 22 E-13	2621 V		64
SAF - Holland	3.229.0039.00	1 DK 22 E-14	2626 V		64
SAF - Holland	3.229.0040.00	1 DK 22 E-15	2618 IL		64
SAF - Holland	3.229.0041.00	1 D 28 B-11	2924 V		22
SAF - Holland	3.229.0042.00	1 D 28 E-2	2919 V		25
SAF - Holland	3.229.0043.00	1 DK 22 E-16	2619 IL		65
SAF - Holland	3.229.0047.00	1 D 28 D-11	2927 V		24
SAF - Holland	3.229.2127.00	1 D 28 A-10	2918 V P01		19
SAF - Holland	3.229.2129.00	1 DK 22 E-9	2618 V		66
SAF - Holland	3.229.2131.00	1 D 28 B-10	2923 V		21
SAF - Holland	3.229.2227.00	1 D 28 A-10	2918 V		19
SAF - Holland	3.229.2229.00	1 DK 22 E-9	2618 V		66
SAF - Holland	3.229.2231.00	1 D 28 B-10	2923 V		21
SAF - Holland	3.229.2429.00	1 DK 22 E-9	2618 V		66



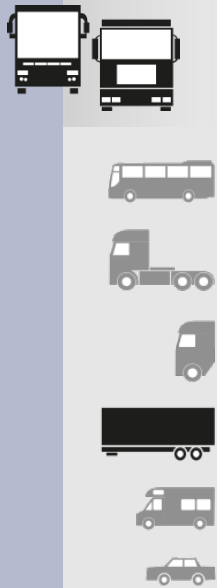

1 Front Axle 2 Mid Axle
3 Rear Axle L Lift Axle



OE	OE #	PHX			
SAF - Holland	3.229.2431.00	1 D 28 B-10	2923 V		21
SAF - Holland	4.229.1004.00	SP 2 B 12 R-5	1609	L	109
SAF - Holland	4.229.1005.00	SP 2 B 12 R-A-3	1608	L	110
SAF - Holland	4.229.1005.01	SP 2 B 12 R-A-3	1608	L	110
SAF - Holland	4.284.3006.00	1 DK 22 E-9 NP	2618 V P02. 2619 V P02		66
SAMRO	H2500008	1 D 28 G-26			26
SAMRO	H2500324	1 DK 23 L-9131			71
SAMRO	H2500361	1 D 28 C-12			24
SAMRO	H2500425	1 DK 23 L-27			70
SAMRO	H2500915	1 DK 25-1			71
SAMRO	H2501122	1 DK 19-1			54
SAMRO	H2501122	1 DK 19-1			54
SAMRO	H2501869	1 DK 20 C-2			56
Schmitz		1 DK 20 B-1 NP	Service Assembly		55
Schmitz		1 DK 23 L-1 NP	Service Assembly		69
Schmitz	013 769	1 DK 21 K	30 K		60
Schmitz	014 892	1 DK 20 B-1			55
Schmitz	015 323	1 D 28 F-1			26
Schmitz	015 514	1 DK 21	30		56
Schmitz	016 010	1 D 28 A-12			20
Schmitz	016 512	1 DK 23 L-1			69
Schmitz	016 558	1 DK 23 L-1			69
Schmitz	016 808	SP 2 B 12 R-A-10		L	109
Schmitz	017 089	1 D 28 F-5			26
Schmitz	017 109	1 DK 21-2	30		62
Schmitz	017 199	1 DK 32 L	36-1		75
Schmitz	017 331	1 DK 21 K-2	30 K		60
Schmitz	017 685	1 D 28 F-5			26
Schmitz	017 924	1 DK 28 F-3			72
Schmitz	0613589	1 D 28 A-2			20
Schmitz	124 4666	1 DK 23 L-1			69
Schmitz	127 0603	1 DK 23 L-2			69
Schmitz	127 4268	1 DK 23 L-2			69
Schmitz	128 8087	1 DK 28 F-3			72
Schmitz	134 4510	1 DK 28 F-3			72
Schmitz	137 1342	1 DK 23 L-2			69
Schmitz	137 5396	1 DK 23 L-2			69
Schmitz	613589	1 D 28 A-2			20
Schmitz	750 208	1 E 25			84
Schmitz	750 209	1 E 32			88
Schmitz	750 212	1 F 32 A			94
Schmitz	750 215	1 F 32 B			95



1 Front Axle 2 Mid Axle
3 Rear Axle L Lift Axle

OE	OE #	PHX			
Schmitz	750 228	1 DK 32	36		74
Schmitz	750 496	1 DK 32-2	36		76
Schmitz	750 570	1 DK 32 K	36 K		74
Schmitz	750 999	1 DK 20 B-1			55
Schmitz	751 065	1 DK 20 A-1			54
Schmitz	751 082	1 D 28 B-10	2923V		21
Schmitz	751 084	1 DK 21 K-2	30 K		60
Schmitz	751 549	1 DK 32-2	36		76
Schmitz	FAG041-0087	1 DK 28 F-3			72
Schmitz	S016512	1 DK 23 L-1			69
Schwarzmüller		SP 2 B 12 R-A-4			110
SMB		1 DK 23 L-27			70
SMB		1 E 21	Truck alteration		80
SMB	08403102	1 D 28 B-2			22
SMB	093770001	1 DK 28 F-3			72
SMB	09377001	1 DK 28 F-3			72
SMB	09377007	1 D 28 A-12			20
SMB	09377008	1 D 28 F-1			26
SMB	09377012	1 DK 21 A-31			57
SMB	1518779	1 DK 23 L-25			70
SMB	1520356	1 DK 23 L-25			70
SMB	1524873	1 DK 23 L-25			70
SMB	1525199	1 DK 23 L-9131			71
SMB	M001464	1 DK 28 D-3			72
SMB	M001472	1 DK 23 K-28			68
SMB	M001774	1 DK 23 L-9131			71
SMB	M001782	1 DK 23 L-25			70
SMB	M060770	1 D 28 H-13			27
SMB	M060924	1 DK 20 A-51			55
SMB	M078580	1 DK 20 C-2			56
SMB	M588762	1 DK 28 D-3			72
Titan	916 8770 0000	1 D 28 B-2			22
Trailor	003 6158 E	1 D 28 B-2			22
Trailor	650 4646 G	1 D 28 A-2			20
Trailor	6502 3482	1 D 28 B-2			22
Transpart	520 728	1 DK 23 K-9082			68
Trouillet	HB 10 315	1 D 28 A-2			20
Trouillet	ST 225-675	1 D 28 B-2			22
Valx	80131003	1 D 28 F-1	HD100		26
Valx	81005002	SP 2 B 12 R-A-10	HD100	L	109
Viberti	128 147 122	1 D 28 B-2			22
Viberti	128147102	1 DK 28 B-7			71



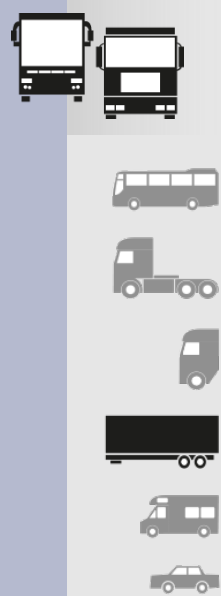

1 Front Axle 2 Mid Axle
3 Rear Axle L Lift Axle



OE	OE #	PHX			
Viberti	128147109	1 D 23 E-2			18
Viberti	128147117	1 DK 28 B-7			71
Viberti	644 285	1 D 28 B-2			22
Wackenhut		1 E 32			88
Weweler		1 DK 21 A-4 NP	Service Assembly		58
Weweler		1 DK 23 K-1 NP	Service Assembly		68
Weweler	2120 8082	1 D 28 A-2			20
Weweler	US 00622	1 D 28 A-2			20
Weweler	US 04028	1 D 28 F-1			26
Weweler	US 04029P	1 D 28 F-5			26
Weweler	US 04030F	1 DK 28 F-3			72
Weweler	US 04030G	1 DK 28 F-3			72
Weweler	US 04030P	1 DK 28 F-3			72
Weweler	US 04031P	1 D 28 F-5			26
Weweler	US 04881R	1 DK 32 K-1			75
Weweler	US 06285	1 DK 20 B-1			55
Weweler	US 06287	1 DK 21 A-4			57
Weweler	US 06316	1 DK 20 A-1			54
Weweler	US 06318F	1 DK 23 L-1			69
Weweler	US 06910	SP 2 B 12 R		L	108
Weweler	US 07074C	1 DK 21 A-3	AC 524/514		57
Weweler	US 07074F	1 DK 21 A-31	AC 524/514		57
Weweler	US 07074P	1 DK 21 A-3	AC 524/514		57
Weweler	US 07337	1 D 28 A-2			20
Weweler	US 07337 ST2	1 D 28 A-12			20
Weweler	US 07337CST2	1 D 28 A-12			20
Weweler	US 07337F1	1 D 28 A-2			20
Weweler	US 07337FST2	1 D 28 A-12			20
Weweler	US 07337G1	1 D 28 A-2			20
Weweler	US 07337GST2	1 D 28 A-12			20
Weweler	US 07337PST2	1 D 28 A-12			20
Weweler	US 07337R	1 D 28 A-13			20
Weweler	US 07337RP	1 D 28 A-13			20
Weweler	US 07345	1 D 28 B-2			22
Weweler	US 07364F	1 DK 21 A-4			57
Weweler	US 07380	1 D 28 C-12			24
Weweler	US 07385	1 D 28 D-10			24
Weweler	US 07394	SP 2 B 12 R-A-10	AC 173	L	109
Weweler	US 07394C	SP 2 B 12 R-A-10		L	109
Weweler	US 07394F	SP 2 B 12 R-A-10		L	109
Weweler	US 08840	1 DK 21 A-3	AC 524/514		57
Weweler	US 09361F	1 DK 23 K-9082			68





1 Front Axle 2 Mid Axle
3 Rear Axle L Lift Axle

OE	OE #	PHX			
Weweler	US 35864	1 DK 23 K-1	AC 128/131		67
Weweler	US 35864	1 DK 23 K-1	AC 138		67
Weweler	US 86318F	1 DK 23 L-1			69
Weweler	US 87408	1 D 28 B-2			22
Weweler	US 87413	1 D 28 A-2	AC 041/115/134		20
Weweler	US 87413	1 D 28 A-2	AC 134 L/138		20
Weweler	US 874131	1 D 28 A-2			20
Weweler	US 87EUROF	1 DK 21 A-4			57
Weweler	US 96681	1 D 28 D-2			25
Weweler	US 97306	1 DK 23 K-9082			68
Weweler	YP06285F	1 DK 20 B-1			55
Weweler	YP06316F	1 DK 20 A-1			54
Weweler	YP06318SF	1 DK 23 L-2			69
Weweler	YP07074W	1 DK 21 A-31			57
Weweler	YP07337ST2F	1 D 28 A-12			20
Weweler	YP07337ST2RF	1 D 28 A-13			20
Weweler	YP07364F	1 DK 21 A-4			57
Weweler	YP07380F	1 D 28 C-12			24
Weweler	YP07394F	SP 2 B 12 R-A-10			109
Weweler	YP4028N2-F	1 D 28 F-1			26
Weweler	YP4030N-F	1 DK 28 F-3			72
Weweler	YP4031N-F	1 D 28 F-5			26
Weweler	YP87408SF	1 D 28 B-2			22
Weweler	YP87413SF	1 D 28 A-2			20
York	61.506243.01	1 D 28 G-26			26
Zorzi	1006551	1 D 23 E-3			18
Zorzi	1006552	1 DK 28 D-3			72
Zorzi	1006553	1 DK 28 B-7			71
Zorzi	1006554	1 DK 28 B-7			71





1 Front Axle 2 Mid Axle
3 Rear Axle L Lift Axle

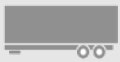

OE	OE #	PHX			
Mercedes	A 638 328 05 01	C 100 004	Vito		106



1 Front Axle
2 Rear Axle

OE	OE #	PHX			
Mercedes	A 100 320 01 17	1 A 06 Z			17
Mercedes	A 112 320 00 17	1 A 04 Z			17
Mercedes	A 112 320 00 21	1 A 05 Z			17





1 Front Axle
2 Rear Axle





Umschlüsselungsliste | Cross reference
Listes de conversion des références
Lista de referencias cruzadas
Перечень перекодировки продукции
Lista krosująca



153	Airtech Ref. > PHOENIX
156	Airtech No. > PHOENIX
159	Blacktech > PHOENIX
162	CF Gomma No. > PHOENIX
164	CF Gomma Ref. > PHOENIX
166	ContiTech > PHOENIX
169	Dunlop UK > PHOENIX
170	Dunlop F > PHOENIX
172	Firestone No. > PHOENIX
175	Firestone Style > PHOENIX
178	Gart No. > PHOENIX
180	Gart Ref. > PHOENIX
182	Goodyear > PHOENIX
185	Neotec > PHOENIX
187	Prime-Ride New > PHOENIX
190	Prime-Ride > PHOENIX
191	Springride > PHOENIX
194	Vibracoustic > PHOENIX





Airtech Ref.	PHOENIX	
2B-220	SP 2 B 12 R	108
2B-220-3	SP 2 B 12 R-5	109
2B-285	2 B 20 R	100
30283 C	1 DK 28 F-3	72
30285 C	1 D 28 F-5	26
30789	1 E 21 B	81
30792	1 E 18 E	80
31324 P	1 DK 32 E-4	74
31415	1 E 23 A	83
31415-01 C	1 E 23 A-1	83
3159	1 E 26 A	86
31885	1 F 20 B	89
31888	1 E 25 B	85
31924	2 F 18	104
31924 C	2 F 18-1	104
323290	1 E 21 D	81
32619 CPP	1 DK 22 E-11	63
32619 P	1 DK 22 E-9 NP	66
32619-01 CPP	1 DK 22 E-16	65
32621 CPP	1 DK 22 E-13	64
32626 CPP	1 DK 22 E-14	64
32918 C	1 D 28 A-10	19
32919 CPP	1 D 28 E-2	25
32922 C	1 D 28 E-1	25
32924 CPP	1 D 28 B-11	22
32926 C	1 D 28 D-10	24
32927 CPP	1 D 28 D-11	24
330301-02 C	1 DF 23 B-1	44
330302 C	1 DF 23 A-1	42
330304 C	1 DF 20 A-3	34
330305 C	1 DF 20 A-2	34
330306 C	1 DF 20 A-1	33
330307 C	1 DF 23 B-2	44
331114 C	1 DF 20 C-1	36
331237 C	1 DF 23 B-4	45
331238 C	1 DF 23 A-2	43
331239 C	1 DF 20 C-2	37
331240 C	1 DF 20 A-5	35
331241 C	1 DF 20 A-6	35
331242 C	1 DF 20 A-7	35
331243 C	1 DF 20 A-8	36
331246 C	1 DF 23 B-5	45
331247 C	1 DF 23 A-3	43

Airtech Ref.	PHOENIX	
334506 C	1 DF 20 A-4	34
33833 C	1 DF 25 C-1	51
33833 P	1 DF 25 C-1 NP	51
34004 C	1 DK 22 E-5	65
34004 CPP	1 DK 22 E-8	66
34004-05 C	1 DK 22 E-5	65
34022-01 P	1 DK 22 E-9 NP	66
34022-03 CPP	1 DK 22 E-9	66
34023 C	1 D 28 B-10	21
34023 P	1 D 28 B-10 NP	21
34028 C	1 D 28 F-1	26
3415-25	2 G 20	105
3415-28	2 G 20 A	105
34154 CPP	1 DK 23 F-1	67
34156 C	1 DK 23 K-28	68
34156 CPP	1 DK 23 K-1	67
34156-05 CPP	1 DK 23 K-9082	68
34157 CPP	1 DK 21 C-4	59
34157-08 CPP	1 DK 20 C-2	56
34158 CPP	1 DK 20 B-1	55
34158 P	1 DK 20 B-1 NP	55
34159 P	1 DK 21 B-5 NP	59
34159-01 C	1 DK 23 L-27	70
34159-02 C	1 DK 23 L-27	70
34159-02 CPP	1 DK 23 L-9131	71
34159-05 C	1 DK 23 L-25	70
34159-10 CPP	1 DK 21 B-4	58
34159-S1 C ALU	1 DK 23 L-31	70
34183-23 C	1 KF 32-23	99
34183-23 P	1 KF 32-23 NP	99
34183-24 C	1 KF 32-23	99
34183-24 P	1 KF 32-23 NP	99
34390-01 C	1 KF 21-1	95
34390-01 P	1 KF 21-1 NP	95
34390-02 C	1 KF 21-2	96
34390-02 P	1 KF 21-2 NP	96
34390-21 C	1 KF 21-21	96
34390-21 P	1 KF 21-1 NP	95
34390-22 C	1 KF 21-22	97
34390-22 P	1 KF 21-2 NP	96
3450-25	1 E 23	83
34560 C	1 DF 20 D-2	38
34561 C	1 DF 20 F-1	39

ohne Gewähr | without engagement | sans garantie | sin garantia | без участия | bez gwarancji



Airtech Ref.	PHOENIX	
34608 C	1 D 28 H-17	28
34713 C	1 DF 22 C-1	42
34713 P	1 DF 22 C-1 NP	42
34757-01 C	1 KF 24-1	97
34757-01 P	1 KF 24-1 NP	97
34757-02 P	1 KF 24-2 NP	98
34757-09 C	1 KF 24-9	99
34757-21 C	1 KF 24-21	98
34757-29 C	1 KF 24-29	98
34813 C	1 D 28 B-9	23
34881 C	1 DK 32 K-1	75
34881 CPP	1 DK 32 K-2	75
34881 P	1 DK 32 K	74
34882 C	1 DF 16-2	29
34882 P	1 DF 16-2 NP	29
34884 C	1 DF 19 B-1	32
34884 P	1 DF 19 B-1 NP	33
34912 C	1 DK 28 F-4	72
34912-10 C	1 DK 28 F-5	73
34913 C	1 D 28 H-16	27
34914 P	1 D 28 H-16 NP	27
34915-01 C	1 DK 19-1	54
34930 CPP	1 DF 17 B-2	31
34960 P	1 DK 21 K-3	61
36108 C	1 DF 17-1	32
36199 C	1 DF 23 C-1	45
36200 C	1 DF 23 D-1	46
36251 C	1 DK 18 A-1	54
36318 CCP	1 DK 23 L-1	69
36318 P	1 DK 23 L-1 NP	69
36416 C	1 DF 17 B-1	30
36418 C	1 DF 17 A-1	30
36420 C	1 DF 17 C-1	32
3644	1 E 21	80
3661	1 E 25	84
3662	1 E 32	88
36684 CPP	1 DF 20 G-4	41
36684 P	1 DF 20 G-4 NP	41
36685 CPP	1 DF 20 G-3	40
36685 P	1 DF 20 G-3 NP	41
36686 CPP	1 DF 20 G-1	39
36686 P	1 DF 20 G-1 NP	39
36687 CPP	1 DF 20 G-2	40

Airtech Ref.	PHOENIX	
36687 P	1 DF 20 G-2 NP	40
3673	1 F 21 A	92
3701	1 E 26	86
3713	1 F 21 D	93
3716	1 F 26 B-1	93
3719	1 F 32 B	95
3720	1 F 21	91
3725-01 C	1 DF 32-1	53
3728	1 F 32 A	94
3737	1 F 26	93
3757	1 F 26 C	94
3769	1 E 18	78
37803 C	1 DF 20 D-1	37
37804 C	1 DF 20 E-1	38
3782	1 E 21 D	81
3810 C	1 D 28 A-2	20
3810 P	1 D 28 A-5 NP	21
3813 C	1 D 28 B-2	22
3813 P	1 D 28 B-5 NP	23
3813-03 C	1 D 28 B-12	22
3813-08 CPP	1 D 28 B-4	23
38185 CPP	1 DK 20 B-1	55
38186 CPP	1 DK 20 A-1	54
3836 C	1 DF 25-11	52
3836 P	1 DF 25-1 NP	51
3836-02 C	1 DF 25-13	52
3836-02 P	1 DF 25-3 NP	53
3836-04 C	1 DF 25-14	52
3836-06 C	1 DF 25-15	53
3838	1 F 26 D	94
38608 P	1 DK 22 D-1	63
3881 P	1 DK 32	74
3881-01 C	1 DK 32-1	76
3881-01 CPP	1 DK 32-2	76
3882	1 F 16	89
3883	1 F 21 C-2	92
3884	1 F 20 A	89
3896	2 E 18 A	103
3897	2 E 23	103
39002-A3 CPP 90	1 DK 21 A-31	57
39002-A3-01 CPP	1 DK 21 A-3	57
39002-A3/08 CPP	1 DK 20 C-2	56
3909 T	1 D 23 C-1	18

ohne Gewähr | without engagement | sans garantie | sin garantia | без участия | bez gwarancji



Airtech Ref.	PHOENIX	
391303 C	1 D 28 C-12	24
391314 C	1 D 28 D-2	25
391318 C	1 DK 28 B-7	71
3916	1 F 21 C-5	92
3927	2 E 18 B	103
3928	2 E 23 A	104
3940 C	1 DK 21 K-1	60
3940 CPP	1 DK 21 K-2	60
3940 P	1 DK 21 K	60
3941 C	1 DK 21-1	62
3941 P	1 DK 21	56
3941-01 CPP	1 DK 21-2	62
3942 P	1 DK 32 L	75
3944	1 E 21-6	82
3945	1 E 21 C	81
3946	1 F 20 C	90
3975	1 E 10 C	77
A 3001505	2 C 91-10	102

ohne Gewähr | without engagement | sans garantie | sin garantia | без участия | bez gwarancji





Airtech No.	PHOENIX	
110002	1 E 21	80
110022	1 E 25	84
110042	1 E 32	88
110062	1 F 21 A	92
110082	1 E 26	86
110102	1 F 26 B-1	93
110122	1 F 21	91
110162	1 F 26	93
110202	2 E 18 A	103
110222	2 E 23	103
110242	1 F 21 C-5	92
110262	2 E 18 B	103
110282	2 E 23 A	104
110312	1 F 20 C	90
110342	1 E 21-6	82
110362	1 E 21 C	81
110402	1 F 20 B	89
110422	2 G 20	105
110442	2 G 20 A	105
110462	1 E 23	83
110482	1 F 32 B	95
110502	1 F 21 D	93
110562	1 F 21 C-2	92
110582	1 F 26 C	94
110602	1 F 20 A	89
110622	1 F 16	89
110682	1 E 21 D	81
110742	1 E 18	78
110762	1 F 26 D	94
110902	2 F 18	104
110982	1 F 32 A	94
111262	1 E 25 B	85
111382	1 E 21 D	81
111442	1 E 10 C	77
111482	1 E 23 A	83
111532	1 E 18 E	80
111552	1 E 21 B	81
111622	1 E 26 A	86
113001	SP 2 B 12 R	108
113002	SP 2 B 12 R-5	109
114250	2 B 20 R	100
120022	1 D 28 A-5 NP	21
120122	1 D 28 B-5 NP	23

Airtech No.	PHOENIX	
120142	1 DF 25-1 NP	51
120182	1 DF 25-3 NP	53
120222	1 DK 32	74
120242	1 DK 21 K	60
120262	1 DK 21	56
120342	1 D 28 B-10 NP	21
120442	1 DK 21 B-5 NP	59
120462	1 DK 32 K	74
120542	1 DK 32 L	75
120582	1 D 28 H-16 NP	27
120722	1 KF 21-2 NP	96
120742	1 DK 21 K-3	61
120822	1 DK 22 E-9 NP	66
120962	1 D 23 C-1	18
121002	1 DK 20 B-1 NP	55
121051	C 075 185	105
121102	1 KF 21-1 NP	95
121222	1 DF 22 C-1 NP	42
121612	1 DF 20 G-2 NP	40
121632	1 DF 20 G-1 NP	39
121662	1 DK 22 E-9 NP	66
121812	1 DF 20 G-3 NP	41
121832	1 DF 20 G-4 NP	41
122122	1 DF 16-2 NP	29
122162	1 DF 19 B-1 NP	33
122492	1 DK 32 E-4	74
122502	1 KF 32-23 NP	99
122512	1 KF 21-1 NP	95
122522	1 KF 21-2 NP	96
122572	1 KF 24-1 NP	97
122622	1 KF 32-23 NP	99
12272	1 DF 25 C-1 NP	51
122802	1 KF 24-2 NP	98
123042	1 DK 22 D-1	63
123072	1 DK 23 L-1 NP	69
130022	1 D 28 A-2	20
130102	1 D 28 B-2	22
130112	1 DK 22 E-13	64
130202	1 DK 21 K-1	60
130222	1 DK 21-1	62
130282	1 DK 22 E-5	65
130322	1 D 28 B-10	21
130342	1 D 28 F-1	26

ohne Gewähr | without engagement | sans garantie | sin garantia | без участия | bez gwarancji



Airtech No.	PHOENIX	
130362	1 DK 23 F-1	67
130382	1 DK 23 K-1	67
130432	1 D 28 E-1	25
130442	1 DK 23 L-27	70
130522	1 DK 32-1	76
130532	1 DK 22 E-14	64
130642	1 DF 32-1	53
130762	1 DK 23 L-27	70
130782	1 DK 32 K-1	75
130822	1 D 28 B-9	23
130942	1 DK 20 C-2	56
130982	1 KF 21-1	95
131002	1 KF 21-2	96
131022	1 DF 25-11	52
131062	1 DF 25-13	52
131142	1 DK 28 B-7	71
131152	1 D 28 B-11	22
131162	1 D 28 C-12	24
131202	1 DK 28 F-4	72
131302	1 DK 21 C-4	59
131362	1 DF 20 G-1	39
131422	1 DF 20 G-2	40
131472	1 D 28 E-2	25
131532	1 DF 17 B-2	31
131722	1 D 28 D-2	25
131842	1 DF 22 C-1	42
131922	1 DF 25-14	52
131942	1 DF 25-15	53
132042	1 DK 23 L-25	70
132102	1 D 28 B-12	22
132122	1 D 28 H-16	27
132202	1 DK 32-2	76
132222	1 DK 21-2	62
132302	1 DK 23 K-9082	68
132702	1 D 28 D-10	24
132732	1 D 28 H-17	28
132782	1 DK 22 E-8	66
132862	1 DF 23 C-1	45
132902	1 DF 17 B-1	30
132922	1 DK 22 E-11	63
132982	1 KF 24-1	97
133152	1 DF 25 C-1	51
133182	1 DF 23 D-1	46

Airtech No.	PHOENIX	
133202	1 DK 20 B-1	55
133322	1 DK 21 A-3	57
133342	1 DK 32 K-2	75
133362	1 DK 21 K-2	60
133382	1 DK 23 L-9131	71
133422	1 D 28 A-10	19
133682	1 DK 21 B-4	58
133782	1 DK 20 B-1	55
133802	1 DK 20 A-1	54
133902	2 F 18-1	104
133982	1 DK 23 L-31	70
134142	1 DK 23 K-28	68
134262	1 DK 20 C-2	56
134302	1 DF 17 A-1	30
134462	1 DF 20 E-1	38
134582	1 DF 20 A-3	34
134602	1 DF 20 A-4	34
134682	1 DF 23 B-2	44
134702	1 DF 20 A-2	34
134722	1 D 28 F-5	26
134762	1 DK 18 A-1	54
134882	1 KF 24-9	99
135042	1 KF 32-23	99
135182	1 DK 19-1	54
135202	1 DF 20 C-1	36
135282	1 DF 17 C-1	32
135482	1 DF 20 A-1	33
135512	1 DF 16-2	29
135532	1 DF 19 B-1	32
135582	1 DF 20 D-1	37
135602	1 KF 21-21	96
135622	1 KF 21-22	97
135632	1 DF 23 A-1	42
135682	1 KF 24-29	98
135692	1 KF 24-21	98
135782	1 D 28 B-4	23
135792	1 E 23 A-1	83
135822	1 KF 32-23	99
135832	1 DF 17-1	32
135872	1 DK 23 L-1	69
135912	1 DK 28 F-5	73
136102	1 DF 23 B-1	44
136442	1 DK 22 E-9	66

ohne Gewähr | without engagement | sans garantie | sin garantia | без участия | bez gwarancji



Airtech No.	PHOENIX	
136482	1 DK 21 A-31	57
136542	1 DK 28 F-3	72
136702	1 DF 23 B-4	45
136712	1 DF 23 A-2	43
136722	1 DF 20 C-2	37
136732	1 DF 20 A-5	35
136742	1 DF 20 A-6	35
136752	1 DF 20 A-7	35
136762	1 DF 20 A-8	36
136772	1 DF 23 B-5	45
136782	1 DF 23 A-3	43
137432	1 D 28 D-11	24
137442	1 DK 22 E-16	65
137492	1 DK 22 E-5	65
137652	1 DF 20 D-2	38
137662	1 DF 20 F-1	39
17001192	2 C 91-10	102
36198 C	1 DF 23 B-3	44

ohne Gewähr | without engagement | sans garantie | sin garantia | без участия | bez gwarancji

Blacktech	PHOENIX	
210 01 C	C 075 185	105
210 17 C	2 C 91-10	102
2C 18-603 S	2 B 07 R	100
2C 21 P12	SP 2 B 12 R-5	109
2C 21 S01	2 B 12 R	100
BT21001C	C 075 185	105
BT21017C	2 C 91-10	102
RL9027	1 F 21 C-5	92
RL9038	2 E 18 B	103
RL9039	2 E 23 A	104
RL9055	1 E 21-6	82
RL9056	1 E 21 C	81
RL9057	1 F 20 C	90
RL9086	1 E 10 C	77
RL92035	2 F 18	104
RL92526	1 E 23 A	83
RL92996	1 F 20 B	89
RL92999	1 E 25 B	85
RL9526-36	2 G 20	105
RL9526-39	2 G 20 A	105
RL9561-36	1 E 23	83
RL95875	1 E 18 D	79
RL9755	1 E 21	80
RL9772	1 E 25	84
RL9773	1 E 32	88
RL9784	1 F 21 A	92
RL9812	1 E 26	86
RL9820	1 F 32 B	95
RL9824	1 F 21 D	93
RL9827	1 F 26 B-1	93
RL9831	1 F 21	91
RL9839	1 F 32 A	94
RL9848	1 F 26	93
RL9868	1 F 26 C	94
RL9870	1 E 18	78
RL9893	1 E 21 D	81
RL9907	2 E 18 A	103
RL9908	2 E 23	103
RL9949	1 F 26 D	94
RL9993	1 F 16	89
RL9994	1 F 21 C-2	92
RL9995	1 F 20 A	89
RML70081C	1 DK 25-1	71

Blacktech	PHOENIX	
RML7010SP	1 D 23 C-1	18
RML7023C1	1 D 28 D-10	24
RML7023C2	1 D 28 D-2	25
RML70301C	1 DF 23 B-1	44
RML70302C	1 DF 23 A-1	42
RML70303C	1 DF 20 C-1	36
RML70303C1	1 DF 20 C-2	37
RML70304C	1 DF 20 A-3	34
RML70305C	1 DF 20 A-2	34
RML70306C	1 DF 20 A-1	33
RML70307C	1 DF 23 B-2	44
RML70462	1 DF 20 G-1 NP	39
RML70462CP	1 DF 20 G-1	39
RML70463	1 DF 20 G-2 NP	40
RML70463CP	1 DF 20 G-2	40
RML70465	1 DF 20 G-3 NP	41
RML70465CP	1 DF 20 G-3	40
RML70466	1 DF 20 G-4 NP	41
RML70466CP	1 DF 20 G-4	41
RML7051	1 DK 21 K	60
RML7051C	1 DK 21 K-1	60
RML7051CP	1 DK 21 K-2	60
RML7052	1 DK 21	56
RML7052C	1 DK 21-1	62
RML7052CP	1 DK 21-2	62
RML7053	1 DK 32 L	75
RML7053C	1 DK 32 L-1	76
RML71303C	1 D 28 C-12	24
RML71501C	1 DK 28 F-3	72
RML71901C	1 D 28 A-13	20
RML72923CP	1 D 28 B-11	22
RML73108C	1 DF 17-1	32
RML74031C	1 D 28 F-5	26
RML74288C	1 DF 20 A-10	33
RML74506C	1 DF 20 A-4	34
RML74544CP	1 DK 20 C-2	56
RML74580C	1 D 28 C-12	24
RML75023C10	1 DK 28 F-5	73
RML75023C13	1 DK 28 F-6	73
RML75023C7	1 DK 28 F-4	72
RML75024	1 D 28 H-16 NP	27
RML75024C	1 D 28 H-16	27
RML75026C6	1 DK 19-1	54

ohne Gewähr | without engagement | sans garantie | sin garantia | без участия | bez gwarancji



Blacktech	PHOENIX	
RML75071	1 DK 21 K-3	61
RML75115C	1 DK 22 E-5	65
RML75115CP	1 DK 22 E-8	66
RML75119C	1 D 28 C-12	24
RML75133	1 DK 22 E-9 NP	66
RML75133CP	1 DK 22 E-9	66
RML75133CP2	1 DK 22 E-9	66
RML75133CP3	1 DK 22 E-9	66
RML75133CP4	1 DK 22 E-11	63
RML75133CP5	1 DK 22 E-11	63
RML75134	1 D 28 B-10 NP	21
RML75134C	1 D 28 B-10	21
RML75139C2	1 D 28 F-1	26
RML75139C5	1 D 28 B-12	22
RML75260-5	1 DK 21 B-5 NP	59
RML75260C3	1 DK 23 L-27	70
RML75260C7	1 DK 23 L-25	70
RML75260CP/17	1 DK 23 L-1	69
RML75260CP14	1 DK 21 B-4	58
RML75260CP9	1 DK 23 L-9131	71
RML75265C5	1 DK 23 F-1	67
RML75265CP5	1 DK 23 F-1	67
RML75267C7	1 DK 23 K-28	68
RML75267CP14	1 DK 23 K-9082	68
RML75267CP15	1 DK 23 K-1	67
RML75268CP10	1 DK 20 A-51	55
RML75268CP4	1 DK 21 C-4	59
RML75268CP5	1 DK 21 A-3	57
RML75268CP6	1 DK 20 A-1	54
RML75268CP8	1 DK 20 C-2	56
RML75268CP9	1 DK 21 A-31	57
RML75269CP	1 DK 20 B-1	55
RML75270C	1 D 23 E-3	18
RML75296CP	1 DK 20 B-1	55
RML75824	1 DF 22 C-1 NP	42
RML75824C	1 DF 22 C-1	42
RML75921C5	1 D 28 A-10	19
RML75921CP	1 D 28 E-2	25
RML75921CP1	1 D 28 E-2	25
RML75921CP2	1 D 28 E-2	25
RML75924C	1 D 28 B-9	23
RML75992	1 DK 32 K	74
RML75992CP	1 DK 32 K-2	75

Blacktech	PHOENIX	
RML75993	1 DF 16-2 NP	29
RML75993C5	1 DF 16-2	29
RML75995	1 DF 19 B-1 NP	33
RML75995C6	1 DF 19 B-1	32
RML76199C	1 DF 23 C-1	45
RML76200C	1 DF 23 D-1	46
RML76237C	1 DF 23 B-4	45
RML76238C	1 DF 23 A-2	43
RML76240C	1 DF 20 A-5	35
RML76241C	1 DF 20 A-6	35
RML76242C	1 DF 20 A-7	35
RML76243C	1 DF 20 A-8	36
RML76246C	1 DF 23 B-5	45
RML76251C	1 DK 18 A-1	54
RML76318CP	1 DK 23 L-1	69
RML77308CP	1 DK 23 L-31	70
RML77433	1 DF 25 C-1 NP	51
RML77433 C	1 DF 25 C-1	51
RML77527C	1 DF 17 B-1	30
RML77529C	1 DF 17 A-1	30
RML77685C	1 D 28 F-5	26
RML77804C	1 DF 20 E-1	38
RML7836C3	1 DF 32-1	53
RML78608CP	1 DK 22 D-1	63
RML78914C	1 DF 20 D-1	37
RML79002A3CP	1 DK 21 A-3	57
RML79002A3CP1	1 DK 21 A-31	57
RML79003A3CP1	1 DK 21 A-31	57
RML79003A8CP	1 DK 21 A-3	57
RML79003A8CP1	1 DK 21 A-31	57
RML7921	1 D 28 A-5 NP	21
RML7921C	1 D 28 A-2	20
RML7924	1 D 28 B-5 NP	23
RML7924C	1 D 28 B-2	22
RML79269	1 DK 20 B-1 NP	55
RML79296	1 DK 20 B-1 NP	55
RML7947	1 DF 25-1 NP	51
RML7947-2	1 DF 25-3 NP	53
RML7947-2C1	1 DF 25-13	52
RML7947C1	1 DF 25-11	52
RML7947C10	1 DF 23 A-4	43
RML7947C4	1 DF 25-14	52
RML7947C6	1 DF 25-15	53

ohne Gewähr | without engagement | sans garantie | sin garantia | без участия | bez gwarancji



Blacktech	PHOENIX	
RML7947C7	1 DF 25-3 NP	53
RML7990C2	1 DF 17 B-3	31
RML7992	1 DK 32	74
RML7992C	1 DK 32-1	76
RML7992CP	1 DK 32-2	76
RML92526C	1 E 23 A-1	83
RML95294-1	1 KF 32-23 NP	99
RML95294-2	1 KF 32-23 NP	99
RML95294C1	1 KF 32-23	99
RML95294C21	1 KF 32-23	99
RML95294C23	1 KF 32-23	99
RML95294C24	1 KF 32-23	99
RML95401-1	1 KF 21-1 NP	95
RML95401-2	1 KF 21-2 NP	96
RML95401-3	1 KF 21-2 NP	96
RML95401C1	1 KF 21-1	95
RML95401C2	1 KF 21-2	96
RML95401C21	1 KF 21-21	96
RML95401C22	1 KF 21-22	97
RML95868-1	1 KF 24-1 NP	97
RML95868-2	1 KF 24-2 NP	98
RML95868C1	1 KF 24-1	97
RML95868C21	1 KF 24-21	98
RML95868C29	1 KF 24-29	98
RML95868C9	1 KF 24-9	99

ohne Gewähr | without engagement | sans garantie | sin garantia | без участия | bez gwarancji



CF Gomma No.	PHOENIX	
200751	1 DK 23 L-9131	71
201840	1 DK 28 D-3	72
202265	1 F 20 B	89
202302	1 DK 23 L-25	70
202442	1 D 28 D-2	25
203000	2 G 20	105
203001	2 G 20 A	105
203386	1 E 23	83
203715	1 DK 22 E-8	66
203833	1 E 21 E	82
204124	1 DK 21 B-4	58
204250	1 F 21 C-2	92
204466	1 DK 21	56
204530	1 DK 32	74
204676	1 D 28 B-10	21
204677	1 DK 22 E-9	66
205170	1 DK 21-1	62
205456	1 D 28 A-10	19
205536	1 DK 21 K	60
205537	1 DK 32 K	74
205598	1 DK 21 A-31	57
205800	1 DK 32-1	76
205868	1 D 28 E-1	25
206201	1 D 28 H-16	27
206333	1 D 28 D-10	24
206340	1 DK 22 E-9	66
206356	1 DK 21-2	62
206357	1 DK 32-2	76
206585	1 DK 22 E-11	63
206684	1 DF 20 G-3	40
206685	1 DF 20 G-4	41
206686	1 DF 20 G-1	39
206687	1 DF 20 G-2	40
206718	1 D 23 E-3	18
206730	1 E 14	77
206779	1 DK 28 F-4	72
206782	1 KF 21-1 NP	95
206784	1 KF 21-2 NP	96
206785	1 KF 24-1	97
206787	1 DF 19 B-1	32
206788	1 DF 16-2	29
206797	SP 2 B 12 R	108
206890	1 D 28 B-11	22

CF Gomma No.	PHOENIX	
206925	1 DK 20 A-51	55
207065	SP 2 B 12 R-17	109
207065	SP 2 B 12 R-A-3	110
207170	1 DF 20 G-3 NP	41
207171	1 DF 20 G-4 NP	41
207172	1 DF 20 G-1 NP	39
207173	1 DF 20 G-2 NP	40
207308	1 DK 21 K-2	60
207309	1 DK 32 K-2	75
207463	1 DK 21 A-4	57
207701	1 DF 16-2	29
207702	1 DF 19 B-1	32
207711	1 DK 21 K-3	61
207719	1 DK 22 E-13	64
207722	1 DK 22 E-14	64
207725	1 F 20 C	90
207732	1 D 28 A-10	19
207759	1 DF 19 B-1 NP	33
207760	1 DF 16-2 NP	29
207765	1 KF 21-1	95
207767	1 DK 23 K-9082	68
207768	1 DK 20 C-2	56
207769	1 DK 28 F-5	73
207772	1 D 28 H-16 NP	27
207773	SP 2 B 12 R-5	109
207775	1 DF 22 C-1	42
207776	SP 2 B 12 R-A-10	109
207777	1 DK 23 K-1	67
207778	1 DK 21 A-3	57
86599	2 B 12 R	100
87408	1 D 28 B-2	22
87413/1	1 D 28 A-2	20
88786	1 E 21-6	82
88786	1 F 21 A	92
88788	2 E 23	103
88802	1 F 21	91
89430	2 B 49 R-A	102
89749/97141	2 B 34 R-B	101
89753	1 D 23 C-1	18
90609	1 E 14	77
91016	1 E 25	84
92548	1 F 26 B-1	93
92574	1 E 21	80

ohne Gewähr | without engagement | sans garantie | sin garantia | без участия | bez gwarancji



CF Gomma No.	PHOENIX	
92575	1 F 32 A	94
92593	1 F 32 B	95
92594	1 E 32	88
93762	1 DK 28 B-7	71
96864	1 D 23 E-2	18
96871	1 D 23 E-3	18
96997	1 D 28 D-2	25
97042	1 F 16	89
97043	1 F 20 A	89
97043	1 F 20 B	89
97306	1 DK 23 L-27	70
97393	1 D 28 C-12	24
97555	1 E 21 C	81
97555	1 E 21 D	81
97608	1 F 20 A	89
97619	1 E 21-6	82
97722	1 DK 22 E-5	65
97764	1 D 28 B-9	23
ST200860C	SP 2 B 22 R-1	111

ohne Gewähr | without engagement | sans garantie | sin garantia | без участия | bez gwarancji



CF Gomma Ref.	PHOENIX	
1S215-22	1 E 14	77
1S270-23C	1 E 21-6	82
1S270-25C	1 F 20 A	89
1S270-26	1 E 21 E	82
1S280-25	2 G 20	105
1S280-28	2 G 20 A	105
1S285-22	1 E 21-6	82
1S285-24	1 E 21	80
1S285-25	1 E 21 C	81
1S285-25C	1 E 21 D	81
1S300-27	1 E 23	83
1S310-28RF	1 E 25	84
1S320-30	2 E 23	103
1SC250-28	1 F 16	89
1SC250-29	1 F 21 C-2	92
1SC270-28	1 F 20 A	89
1SC270-28	1 F 20 B	89
1SC270-30	1 F 20 B	89
1SC285-22	1 F 21 A	92
1SC290-28	1 F 20 C	90
1SC290-30	1 F 21	91
1SC300-34	1 F 26 B-1	93
1SC360-30	1 E 32	88
1SC360-34	1 F 32 A	94
1SC360-43	1 F 32 B	95
1T19E-1	1 D 28 A-10	19
1T19E-1	1 D 28 A-2	20
1T19E-1	1 D 28 E-1	25
1T19E-2	1 D 28 A-10	19
1T19E-2	1 D 28 B-10	21
1T19E-2	1 D 28 B-11	22
1T19E-2	1 D 28 B-2	22
1T19E-2	1 DK 28 B-7	71
1T19E-2BR	1 D 28 B-9	23
1T19E-2L	1 D 28 D-10	24
1T19E-3	1 D 28 C-12	24
1T19E-3	1 DK 28 D-3	72
1T19E-4	1 D 28 D-2	25
1T19E-4	1 DK 28 F-4	72
1T19E-4	1 DK 28 F-5	73
1T19E-93	1 D 28 H-16	27
1T19E-93	1 D 28 H-16 NP	27
1T300-37	1 DK 20 C-2	56

CF Gomma Ref.	PHOENIX	
1T300-37	1 DK 22 E-11	63
1T300-37	1 DK 22 E-13	64
1T300-37	1 DK 22 E-14	64
1T300-37	1 DK 22 E-8	66
1T300-37	1 DK 22 E-9	66
1T300-40	1 DK 21 A-4	57
1T320SP	1 D 23 C-1	18
1T323-32	1 DK 21 A-3	57
1T323-32	1 DK 23 K-1	67
1T323-32	1 DK 23 K-9082	68
1T323-33	1 DK 22 E-5	65
1T323-40	1 D 23 E-2	18
1T323-40	1 D 23 E-3	18
1T323-40	1 DK 21 B-4	58
1T323-40	1 DK 21 B-5 NP	59
1T323-40	1 DK 23 L-25	70
1T323-40	1 DK 23 L-27	70
1T323-40	1 DK 23 L-9131	71
1T323-41	1 D 23 E-3	18
1TC300-30	1 DK 21 K	60
1TC300-30K	1 DK 21 K-2	60
1TC300-30K	1 DK 21 K-3	61
1TC300-36	1 DK 21	56
1TC300-36	1 DK 21-1	62
1TC300-36	1 DK 21-2	62
1TC300-38	1 DK 20 A-51	55
1TC300-38	1 DK 21 A-31	57
1TC360-40	1 DK 32 K	74
1TC360-40K	1 DK 32 K-1	75
1TC360-40K	1 DK 32 K-2	75
1TC360-45	1 DK 32	74
1TC360-45	1 DK 32-1	76
1TC360-45	1 DK 32-2	76
1TS260-28	1 DF 16-2	29
1TS260-32	1 DF 16-2	29
1TS260-32	1 DF 16-2 NP	29
1TS270-23	1 DF 20 G-1	39
1TS270-23	1 DF 20 G-1 NP	39
1TS270-23	1 DF 20 G-2	40
1TS270-23	1 DF 20 G-2 NP	40
1TS270-23	1 DF 20 G-3	40
1TS270-23	1 DF 20 G-3 NP	41
1TS270-23	1 DF 20 G-4	41

ohne Gewähr | without engagement | sans garantie | sin garantia | без участия | bez gwarancji



CF Gomma Ref.	PHOENIX	
1TS270-23	1 DF 20 G-4 NP	41
1TS290-28	1 DF 19 B-1	32
1TS290-28	1 DF 19 B-1 NP	33
1TS300-28	1 DF 22 C-1	42
1TS300-28	1 DF 22 C-1 NP	42
1VS285-30	1 KF 21-1	95
1VSC285-30	1 KF 21-1 NP	95
1VSC285-30	1 KF 21-2 NP	96
1VSC330-26	1 KF 24-1	97
20	2 B 12 R	100
20	SP 2 B 12 R	108
20	SP 2 B 12 R-5	109
20L	SP 2 B 12 R-A-10	109
20L	SP 2 B 12 R-A-3	110
28B	2 B 49 R-A	102
T20L	SP 2 B 12 R-17	109
T21B	2 B 34 R-B	101
T22B	SP 2 B 22 R-1	111

ohne Gewähr | without engagement | sans garantie | sin garantia | без участия | bez gwarancji





ContiTech	PHOENIX	
1415 N	1 E 23 A	83
1415 N P01	1 E 23 A-1	83
1416 N	1 E 25 A	85
1417 N	1 E 23 B	84
1417 N P01	1 E 23 B-1	84
1819 N	1 E 14	77
1885 N1	1 F 20 B	89
1888 N	1 E 25 B	85
1924 N1	2 F 18	104
1924 N1 P05	2 F 18-1	104
4004 N P03	1 DK 22 E-8	66
4004 N P05	1 DK 22 E-5	65
4022 N P02	1 DK 22 E-9 NP	66
4022 N P03	1 DK 22 E-9	66
4022 N P05	1 DK 22 E-11	63
4022 N P06	1 DK 22 E-14	64
4022 N P07	1 DK 22 E-13	64
4022 N P08	1 DK 22 E-16	65
4023 N P03	1 D 28 B-10	21
4023 N P06	1 D 28 B-10 NP	21
4023 N P12	1 D 28 B-11	22
4028 N P02	1 D 28 F-1	26
4028 N P05	1 D 28 B-12	22
4035 N P02	1 DK 28 F-3	72
4154 N P05	1 DK 23 F-1	67
4156 N P05	1 DK 23 K-1 NP	68
4156 N P07	1 DK 23 K-28	68
4156 N P14	1 DK 23 K-9082	68
4156 N P15	1 DK 23 K-1	67
4157 N P04	1 DK 21 C-4	59
4157 N P05	1 DK 21 A-3	57
4157 N P06	1 DK 20 A-1	54
4157 N P08	1 DK 20 C-2	56
4157 N P09	1 DK 21 A-31	57
4157 N P10	1 DK 20 A-51	55
4157 N P14	1 DK 21 C-4	59
4158 N P02	1 DK 20 B-1 NP	55
4158 N P03	1 DK 20 B-1	55
4159 N P03	1 DK 23 L-27	70
4159 N P05	1 DK 21 B-5 NP	59
4159 N P07	1 DK 23 L-25	70
4159 N P09	1 DK 23 L-9131	71
4159 N P14	1 DK 21 B-4	58

ContiTech	PHOENIX	
4162 N P01	1 DK 21 C-5	59
4183 N P23	1 KF 32-23	99
4183 N P24	1 KF 32-23	99
4183 N1	1 KF 32-23 NP	99
4183 N2	1 KF 32-23 NP	99
4390 N P01	1 KF 21-1	95
4390 N P02	1 KF 21-2	96
4390 N P21	1 KF 21-21	96
4390 N P22	1 KF 21-22	97
4390 N1	1 KF 21-1 NP	95
4390 N2	1 KF 21-2 NP	96
4560 N P02	1 DF 20 D-2	38
4561 N P02	1 DF 20 F-1	39
4570 N P02	1 DF 17 B-4	31
4570 N P03	1 DF 17 B-1	30
4571 N P02	1 DF 17 A-2	30
4713 N P02	1 DF 22 C-1	42
4713 N P04	1 DF 22 C-1 NP	42
4757 N P01	1 KF 24-1	97
4757 N P09	1 KF 24-9	99
4757 N P21	1 KF 24-21	98
4757 N P29	1 KF 24-29	98
4757 N1	1 KF 24-1 NP	97
4757 N2	1 KF 24-2 NP	98
4810 N P05	1 D 28 A-10	19
4810 N P13	1 D 28 E-2	25
4813 N P07	1 D 28 B-9	23
4881 N P02	1 DK 32 K	74
4881 N P30	1 DK 32 K-2	75
4882 N1 P01	1 DF 16-2 NP	29
4882 N1 P05	1 DF 16-2	29
4884 N1 P01	1 DF 19 B-1 NP	33
4884 N1 P06	1 DF 19 B-1	32
4912 N P07	1 DK 28 F-4	72
4912 N P10	1 DK 28 F-5	73
4912 N P13	1 DK 28 F-6	73
4913 N P02	1 D 28 H-16	27
4913 N P04	1 D 28 H-16 NP	27
4915 N P06	1 DK 19-1	54
4960 N P02	1 DK 21 K-3	61
603 N	2 B 07 R	100
608 N	2 B 20 R	100
6122 N P46	1 DF 16 A-1	28

ohne Gewähr | without engagement | sans garantie | sin garantia | без участия | bez gwarancji



ContiTech	PHOENIX	
6122 N P47	1 DF 16 A-2	29
61456 M	1 DF 17 B-1	30
644 N	1 E 21	80
6600 N P02	1 DF 17 C-1	32
6604 N P01	1 DF 17-1	32
6605 N P01	1 DF 20 D-1	37
6606 N P01	1 DF 20 E-1	38
6607 N P01	1 DF 17 A-1	30
6608 N P01	1 DF 17 B-1	30
661 N	1 E 25	84
661 N P02	1 E 25-5	85
662 N	1 E 32	88
6620 N P01	1 DF 25 C-1 NP	51
6620 N P02	1 DF 25 C-1	51
6621 N	1 E 18 D	79
6621 N P01	1 E 18 D-01	79
6621 N P02	1 E 18 D-02	79
6621 N P03	1 E 18 D-03	80
6622 N	1 E 21 F	82
6623 N	1 E 18 C	78
6631 N P01	1 DF 20 E-2	38
6700 N P02	1 D 28 H-17	28
6701 N P01	1 DF 23 D-1	46
6702 N P01	1 DF 23 C-2	46
6703 N P01	1 DF 23 B-3	44
6704 N P01	1 DF 23 C-1	45
6705 N P01	1 DK 18 A-1	54
6706 N P01	1 DK 23 L-31	70
6708 N P01	1 DF 23 A-1	42
6708 N P02	1 DF 23 A-2	43
6710 N P01	1 DF 20 A-3	34
6710 N P02	1 DF 20 A-2	34
6710 N P03	1 DF 20 A-5	35
6710 N P04	1 DF 20 A-6	35
6711 N P01	1 DF 23 B-2	44
6711 N P02	1 DF 23 B-5	45
6712 N P02	1 DF 23 A-3	43
6713 N P02	1 DF 23 B-4	45
6716 N P02	1 DF 20 C-4	37
673 N	1 F 21 A	92
701 N	1 E 26	86
702 N	1 E 26 A	86
713 N	1 F 21 D	93

ContiTech	PHOENIX	
716 N	1 F 26 B-1	93
719 N	1 F 32 B	95
720 N	1 F 21	91
725 N P03	1 DF 32-1	53
728 N	1 F 32 A	94
737 N	1 F 26	93
757 N	1 F 26 C	94
769 N	1 E 18	78
782 N	1 E 21 D	81
809 NTB	1 D 23 C-1	18
810 MB	1 D 28 A-2	20
810 MB/O	1 D 28 A-5 NP	21
813 MB	1 D 28 B-2	22
813 MB/O	1 D 28 B-5 NP	23
82215 M	1 DF 17 B-1	30
836 M	1 DF 25-1 NP	51
836 M K1	1 DF 25-11	52
836 M2	1 DF 25-3 NP	53
836 M2 K1	1 DF 25-13	52
836 MB K4	1 DF 25-14	52
836 MB K6	1 DF 25-15	53
836 N P10	1 DF 23 A-4	43
838 N	1 F 26 D	94
881 MB	1 DK 32	74
881 MB P30	1 DK 32-2	76
882 N1	1 F 16	89
883 N1	1 F 21 C-2	92
884 N	1 F 20 A	89
889 M K2	1 DF 17 B-3	31
896 N	2 E 18 A	103
897 N	2 E 23	103
909 NTB	1 D 23 C-1	18
912 N P01	1 D 28 D-10	24
912 N P02	1 D 28 D-2	25
912 N P04	1 D 28 D-11	24
916 N1	1 F 21 C-5	92
927 N	2 E 18 B	103
928 N	2 E 23 A	104
940 MB	1 DK 21 K	60
940 MB P01	1 DK 21 K-4	61
940 MB P30	1 DK 21 K-2	60
941 MB	1 DK 21	56
941 MB P01	1 DK 21-4	62

ohne Gewähr | without engagement | sans garantie | sin garantia | без участия | bez gwarancji



ContiTech	PHOENIX	
941 MB P30	1 DK 21-2	62
942 MB	1 DK 32 L	75
942 MB P01	1 DK 32 L-1	76
944 N	1 E 21-6	82
945 N	1 E 21 C	81
946 N	1 F 20 C	90
946 N P01	1 F 20 C-1	90
946 N P02	1 F 20 C-2	90
946 N P03	1 F 20 C-3	91
946 N P04	1 F 20 C-4	91
975 N	1 E 10 C	77
976 N	1 E 10 C	77
FD 1120-30	2 B 49 R-B	102
FD 200-19 1/4 M10	SP 2 B 12 R	108
FD 200-19 3/4 M8	SP 2 B 12 R-1	108
FD 200-19 P02	SP 2 B 12 R-17	109
FD 200-19 P04	SP 2 B 12 R-5	109
FD 200-19 P08	SP 2 B 12 R-5	109
FD 200-19 S	2 B 12 R	100
FD 200-25 1/4 M10	SP 2 B 12 R-A-10	109
FD 200-25 M24 M10	SP 2 B 12 R-B-1	110
FD 200-25 P02	SP 2 B 12 R-A-3	110
FS 200-10 3/4 M8	SP 1 B 12-1	107
FS 530-11 3/4 M8	SP 1 B 34	107
RZ 415-25	2 G 20	105
RZ 415-28	2 G 20 A	105
RZ 450-25	1 E 23	83
SK 86-10	2 C 91-10	102
SZ 50-9 P02	C 075 185	105

ohne Gewähr | without engagement | sans garantie | sin garantia | без участия | bez gwarancji



Dunlop UK	PHOENIX	
00628A-AP	1 E 10 C	77
00934A-AP	1 DK 32-2	76
00935A-AP	1 DK 21-1	62
00935A-AP	1 DK 21-2	62
00936A-AP	1 DK 21 K-2	60
00937A-AP	1 D 28 H-16	27
00980A-AP	1 DK 21 A-4	57
00980B-AP	1 DK 21 A-3	57
00981A-AP	1 DK 23 K-28	68
00981B-AP	1 DK 23 K-1	67
00982A-AP	1 DK 23 L-25	70
00984A-AP	1 D 28 A-2	20
00985A-AP	1 D 28 B-2	22
00986A-AP	2 G 20	105
01128A-AP	SP 2 B 12 R	108
01397A-AP	1 DF 20 A-1	33
01398A-AP	1 DF 20 A-2	34
01399A-AP	1 DF 20 A-3	34
IC3308	2 E 23 A	104
PNP037690200	1 E 18	78
PNP300080100	2 E 18 B	103
PNP301000100	1 F 21	91
PNP301000101	1 E 21 C	81
PNP301470102	1 E 21	80
PNP302730101	1 E 32	88
PNP304620101	1 F 32 B	95
PNP304980101	1 E 25	84
PNP305140100	2 E 18 A	103
PNP305210101	2 E 23	103
PNP305510111	2 B 07 R	100
PNP306420100	1 F 32 A	94
PNP307520000	1 D 28 A-5 NP	21
PNP311370000	1 DK 21 B-4	58
PNP311370000	1 DK 23 L-27	70

ohne Gewähr | without engagement | sans garantie | sin garantia | без участия | bez gwarancji



Dunlop F	PHOENIX	
6"x2	2 B 07 R	100
D10B01	1 DF 17 B-1	30
D10S02	1 E 18	78
D10U01	1 DF 16-2 NP	29
D11B33	1 DK 21-2	62
D11B34	1 DK 22 E-8	66
D11B36	1 DK 21 K-2	60
D11B37	1 DK 20 A-1	54
D11B38	1 DK 21-1	62
D11B39	1 DK 21 K-1	60
D11B41	1 DK 22 E-11	63
D11B42	1 DF 20 D-1	37
D11S01	1 E 21	80
D11S02	1 E 21 D	81
D11S04	1 E 21-6	82
D11S06	1 F 21 A	92
D11U30	1 DK 21	56
D11U31	1 DK 21 K	60
D11U40	1 DK 22 E-9 NP	66
D11U44	1 DK 21 K-3	61
D11U48	1 DF 19 B-1 NP	33
D12B01	1 DK 21 B-4	58
D12B04	1 DK 23 L-9131	71
D12B08	1 DK 23 L-27	70
D12B09	1 D 23 E-3	18
D12B10	1 D 23 E-2	18
D12B13	1 DK 22 E-8	66
D12B14	1 DK 22 E-9	66
D12B15	1 DK 23 L-25	70
D12B17	1 DK 21 A-31	57
D12B18	1 DK 21 A-4	57
D12B19	1 DK 23 K-28	68
D12B22	1 DK 20 B-1	55
D12B24	1 DF 22 C-1	42
D12B25	1 DK 22 E-5	65
D12B29	1 DK 20 A-51	55
D12B30	1 DK 20 C-2	56
D12B31	1 DK 23 L-31	70
D12B33	1 DK 23 K-9082	68
D12S02RE	1 E 25	84
D12S03	2 E 23 A	104
D12S04	1 F 21	91
D12S05	1 F 21 C-5	92

Dunlop F	PHOENIX	
D12S06	1 F 20 A	89
D12S07	1 F 20 B	89
D12S08	2 G 20	105
D12S09	2 G 20 A	105
D12S12	1 F 16	89
D12S13	1 E 23	83
D12S14	1 E 26 A	86
D12S15	1 F 21 D	93
D12S19	1 F 26 B-1	93
D12S20	1 F 26 C	94
D12S21	1 E 18 D	79
D12T10	1 KF 21-1	95
D12T11	1 KF 21-2	96
D12U04	1 DK 21 B-5 NP	59
D12U23	1 DK 20 B-1 NP	55
D12U24	1 DF 22 C-1 NP	42
D12U25	1 KF 21-1 NP	95
D12U26	1 KF 21-2 NP	96
D12U34	1 D 23 C-1	18
D13B02	1 D 28 B-2	22
D13B03	1 D 28 C-12	24
D13B04	1 DK 28 D-3	72
D13B10	1 D 28 B-9	23
D13B14	1 D 28 D-2	25
D13B18	1 DK 28 B-7	71
D13B19	1 D 28 B-2	22
D13B20	1 D 28 A-2	20
D13B21	1 D 28 H-13	27
D13B22	1 D 28 B-9	23
D13B25	1 D 28 A-10	19
D13B26	1 D 28 B-10	21
D13B29	1 D 28 B-4	23
D13B31	1 DF 25-13	52
D13B32	1 DF 25-11	52
D13B40	1 DK 28 F-4	72
D13B42	1 DK 25-1	71
D13B43	1 DF 25-15	53
D13B45	1 DK 28 F-4	72
D13S01	1 E 32	88
D13S03	1 F 21 C-2	92
D13S04	1 F 32 A	94
D13S05	1 F 26 D	94
D13S06	1 F 26	93

ohne Gewähr | without engagement | sans garantie | sin garantia | без участия | bez gwarancji



Dunlop F	PHOENIX	
D13T01	1 KF 24-1	97
D13T01	1 KF 24-21	98
D13T02	1 KF 24-29	98
D13T02	1 KF 24-9	99
D13U31	1 DF 25-3 NP	53
D13U32	1 DF 25-1 NP	51
D13U42	1 KF 24-1 NP	97
D13U43	1 KF 24-2 NP	98
D13U45	1 DF 25 B-1 NP	50
D14B36	1 DK 32-1	76
D14B37	1 DK 32 K-1	75
D14B41	1 DK 32-2	76
D14B42	1 D 28 H-16	27
D14B43	1 D 28 B-11	22
D14B43	1 DF 32-1	53
D14B44	1 DK 32 K-2	75
D14B47	1 D 28 F-1	26
D14B48	1 D 28 A-12	20
D14B49	1 D 28 F-5	26
D14B51	1 D 28 B-12	22
D14B52	1 D 28 D-10	24
D14B55	1 D 28 A-13	20
D14U36	1 DK 32	74
D14U37	1 DK 32 K	74
D14U42	1 D 28 H-16 NP	27
D14U50	1 DK 32 E-4	74
S09201	SP 2 B 12 R-5	109
S09201NB	SP 2 B 12 R	108
S09204	SP 2 B 12 R-A-3	110
SP2191	2 E 18 A	103
SP2192	2 E 23	103

ohne Gewähr | without engagement | sans garantie | sin garantia | без участия | bez gwarancji



Firestone No.	PHOENIX	
C01-968-1162	1 D 28 A-2	20
C01-968-1163	1 DK 28 F-3	72
C01-M58-1162	1 D 28 A-2	20
W0-095-0565	1 DF 23 B-4	45
W01-095-0009	2 B 12 R	100
W01-095-0021	1 E 25	84
W01-095-0063	1 E 21 C	81
W01-095-0118	1 E 21	80
W01-095-0121	1 E 21-6	82
W01-095-0145	1 F 26 B-1	93
W01-095-0173	2 E 18 A	103
W01-095-0174	2 E 23	103
W01-095-0191	1 F 32 A	94
W01-095-0192	1 F 32 B	95
W01-095-0195	1 F 21	91
W01-095-0197	1 E 21 D	81
W01-095-0198	1 F 21 A	92
W01-095-0204	1 E 18	78
W01-095-0205	1 E 26	86
W01-095-0207	1 E 32	88
W01-095-0211	1 F 26	93
W01-095-0212	1 F 26 C	94
W01-095-0228	2 E 23 A	104
W01-095-0229	2 E 23	103
W01-095-0244	2 E 18 B	103
W01-095-0245	2 E 18 A	103
W01-095-0295	1 E 21 E	82
W01-095-0365	1 D 28 H-16 NP	27
W01-095-0381	2 G 20	105
W01-095-0382	2 G 20 A	105
W01-095-0389	1 DF 23 B-1	44
W01-095-0405	1 DF 23 B-2	44
W01-095-0422	1 DF 20 C-1	36
W01-095-0429	1 F 20 B	89
W01-095-0435	1 F 16	89
W01-095-0437	1 E 10 C	77
W01-095-0481	1 DF 20 A-2	34
W01-095-0500	1 D 28 H-16	27
W01-095-0555	1 F 21 C-5	92
W01-095-0566	1 DF 20 C-4	37
W01-095-0567	1 DF 20 A-5	35
W01-095-0672	1 E 18 C	78
W01-095-0915	1 F 20 C	90

Firestone No.	PHOENIX	
W01-095-4002	1 E 21	80
W01-095-4047	1 E 21 C	81
W01-095-4048	1 E 21 D	81
W01-095-4058	1 E 25	84
W01-358-8172	1 DK 23 F-1	67
W01-358-9082	1 DK 23 K-9082	68
W01-358-9130	1 DK 23 L-27	70
W01-358-9361	1 DK 23 K-1	67
W01-358-9361	1 DK 23 K-28	68
W01-379-9091	1 DK 23 L-25	70
W01-568-6223	1 DK 28 F-3	72
W01-568-8131	1 DK 23 L-2	69
W01-568-8333	1 DK 23 L-2	69
W01-968-6136	1 DK 20 A-1	54
W01-968-6223	1 DK 28 F-3	72
W01-968-6225	1 D 28 A-12	20
W01-968-6345	1 D 28 A-2	20
W01-968-6771	SP 2 B 12 R-A-10	109
W01-968-8106	1 D 28 F-1	26
W01-968-8108	1 D 28 A-2	20
W01-968-8186	1 DK 20 A-1	54
W01-968-8775	1 D 28 A-2	20
W01-D08-0776	1 DF 25-1 NP	51
W01-D08-0777	1 DF 25-3 NP	53
W01-D08-8705	1 DF 25-14	52
W01-M58-0687	1 D 23 C-1	18
W01-M58-0736	1 DK 21 B-5 NP	59
W01-M58-0756	1 DK 22 E-9 NP	66
W01-M58-0776	1 DF 25-1 NP	51
W01-M58-0777	1 DF 25-3 NP	53
W01-M58-0904	1 KF 21-1 NP	95
W01-M58-0905	1 KF 21-2 NP	96
W01-M58-0909	1 KF 24-1 NP	97
W01-M58-0910	1 KF 24-2 NP	98
W01-M58-5190	1 E 18 D-01	79
W01-M58-5190	1 E 18 D-02	79
W01-M58-5520	1 DK 28 F-6	73
W01-M58-5521	1 DK 28 F-5	73
W01-M58-5540	1 D 28 E-2	25
W01-M58-5541	1 D 28 B-11	22
W01-M58-5542	1 D 28 D-11	24
W01-M58-5787	1 DF 17 C-1	32
W01-M58-5797	1 DF 17 B-2	31

ohne Gewähr | without engagement | sans garantie | sin garantia | без участия | bez gwarancji





Firestone No.	PHOENIX	
W01-M58-6088	1 DF 20 D-2	38
W01-M58-6089	1 DF 20 F-1	39
W01-M58-6100	SP 1 B 34	107
W01-M58-6216	1 D 28 E-1	25
W01-M58-6222	1 D 28 A-13	20
W01-M58-6223	1 DK 28 F-3	72
W01-M58-6225	1 D 28 A-12	20
W01-M58-6251	1 DK 18 A-1	54
W01-M58-6257	1 DK 20 B-1 NP	55
W01-M58-6285	1 DK 20 B-1	55
W01-M58-6289	1 D 23 E-3	18
W01-M58-6297	1 DK 21 A-4	57
W01-M58-6315	1 DK 20 A-51	55
W01-M58-6317	1 DK 20 C-2	56
W01-M58-6318	1 DK 23 L-1	69
W01-M58-6335	1 D 28 B-10 NP	21
W01-M58-6338	1 D 28 A-10	19
W01-M58-6339	1 D 28 B-2	22
W01-M58-6345	1 D 28 A-2	20
W01-M58-6348	1 D 28 B-10	21
W01-M58-6361	1 DK 28 B-7	71
W01-M58-6364	1 D 28 B-2	22
W01-M58-6366	1 DK 22 E-8	66
W01-M58-6367	1 DK 22 E-9	66
W01-M58-6374	SP 1 B 12-1	107
W01-M58-6411	1 DK 23 L-1 NP	69
W01-M58-6500	1 D 28 B-11	22
W01-M58-6887	SP 2 B 12 R	108
W01-M58-6910	SP 2 B 12 R	108
W01-M58-6988	2 B 07 R	100
W01-M58-7074	1 DK 21 A-31	57
W01-M58-7237	1 D 28 A-5 NP	21
W01-M58-7238	1 D 28 B-5 NP	23
W01-M58-7308	1 DK 23 L-31	70
W01-M58-7358	1 D 28 B-9	23
W01-M58-7370	1 D 28 B-12	22
W01-M58-7502	1 D 28 B-4	23
W01-M58-7548	1 DK 21 B-4	58
W01-M58-7548	1 DK 23 L-27	70
W01-M58-7679	SP 2 B 12 R-A-10	109
W01-M58-7756	SP 2 B 12 R-17	109
W01-M58-7888	SP 2 B 12 R	108
W01-M58-7894	SP 2 B 12 R-5	109

Firestone No.	PHOENIX	
W01-M58-8072	1 DK 21-4	62
W01-M58-8073	1 DK 21 K-4	61
W01-M58-8106	1 D 28 F-1	26
W01-M58-8107	1 D 28 F-5	26
W01-M58-8108	1 D 28 A-2	20
W01-M58-8126	1 DK 23 L-1	69
W01-M58-8131	1 DK 23 L-2	69
W01-M58-8172	1 DK 23 F-1	67
W01-M58-8185	1 DK 20 B-1	55
W01-M58-8193	1 DF 23 A-1	42
W01-M58-8194	1 DK 20 A-1	54
W01-M58-8354	1 DF 16-2	29
W01-M58-8355	1 DF 16-2 NP	29
W01-M58-8360	1 DF 19 B-1	32
W01-M58-8361	1 DF 19 B-1 NP	33
W01-M58-8368	1 DF 23 A-4	43
W01-M58-8372	1 DF 25 A-30	49
W01-M58-8377	1 DF 25 A-1	47
W01-M58-8378	1 DF 25 A-11	47
W01-M58-8379	1 DF 25 A-2	48
W01-M58-8470	1 DF 17-1	32
W01-M58-8472	1 DF 20 D-1	37
W01-M58-8473	1 DF 17 A-1	30
W01-M58-8474	1 DF 17 B-1	30
W01-M58-8477	1 DF 20 E-1	38
W01-M58-8502	1 D 28 D-10	24
W01-M58-8513	1 KF 21-22	97
W01-M58-8514	1 KF 21-21	96
W01-M58-8521	1 KF 24-21	98
W01-M58-8522	1 KF 24-29	98
W01-M58-8524	1 DF 23 G-1	46
W01-M58-8535	1 D 28 H-17	28
W01-M58-8545	1 DF 17 B-4	31
W01-M58-8546	1 DF 17 A-2	30
W01-M58-8555	1 DF 20 G-4	41
W01-M58-8556	1 DF 20 G-3	40
W01-M58-8584	1 DK 32 L-1	76
W01-M58-8585	1 DK 21 K-2	60
W01-M58-8587	1 DK 22 E-17	65
W01-M58-8601	1 DK 32 K	74
W01-M58-8602	1 DK 32 K-1	75
W01-M58-8608	1 DK 22 D-1	63
W01-M58-8609	1 DK 21 K-1	60

ohne Gewähr | without engagement | sans garantie | sin garantia | без участия | bez gwarancji





Firestone No.	PHOENIX	
W01-M58-8610	1 DF 32-1	53
W01-M58-8611	1 DK 32 L	75
W01-M58-8612	1 DK 22 E-11	63
W01-M58-8613	1 DK 21 K	60
W01-M58-8618	1 DK 21-2	62
W01-M58-8619	1 DK 21-1	62
W01-M58-8620	1 DK 21	56
W01-M58-8629	1 DK 25-1	71
W01-M58-8633	1 DF 23 G-1	46
W01-M58-8653	1 DF 17 B-2	31
W01-M58-8660	1 DF 20 G-4	41
W01-M58-8661	1 DF 20 G-3	40
W01-M58-8666	1 DK 32 K-2	75
W01-M58-8667	1 DK 32-2	76
W01-M58-8668	1 DK 21-2	62
W01-M58-8679	1 DF 17 B-3	31
W01-M58-8701	1 DF 25-15	53
W01-M58-8721	1 DF 25-13	52
W01-M58-8722	1 DF 25-11	52
W01-M58-8747	1 DK 25-1	71
W01-M58-8762	1 DK 28 D-3	72
W01-M58-8765	1 D 28 C-12	24
W01-M58-8766	1 D 28 D-2	25
W01-M58-8775	1 D 28 A-2	20
W01-M58-8786	1 DK 28 F-4	72
W01-M58-8840	1 DK 21 A-3	57
W01-M58-8859	1 DK 23 L-25	70
W01-M58-8966	1 DK 32-1	76
W01-M58-8978	1 DK 32	74
W01-M58-8988	1 DK 32 E-4	74
W01-M58-9131	1 DK 23 L-9131	71
W01-M58-9706	1 DF 22 C-1	42
W01-M58-9712	1 DK 22 E-14	64
W01-M58-9720	1 DK 21 C-4	59
W01-M58-9879	1 DF 19 B-1	32
W01-M58-9880	1 DF 16-2	29
W01-M58-9881	1 D 28 H-16	27
W01-R58-4088	2 B 20 R	100
W01-R88-8587	1 DK 22 E-17	65
W01-R88-8608	1 DK 22 D-1	63
W01M588557	1 DF 20 G-2	40
W01M588558	1 DF 20 G-1	39
W01M588662	1 DF 20 G-2	40

Firestone No.	PHOENIX	
W01M588663	1 DF 20 G-1	39
W01M8-8373	1 DF 25 A-31	50
W02-M58-8035	C 075 185	105

ohne Gewähr | without engagement | sans garantie | sin garantia | без участия | bez gwarancji





Firestone Style	PHOENIX	
15LR-4-0567	1 DF 20 A-5	35
1R1A-370-285	1 F 21 A	92
1R1A-380-260	1 E 18	78
1R1A-380-260	1 E 18 D-01	79
1R1A-380-260	1 E 18 D-02	79
1R1A-390-295	1 E 21	80
1R1A-415-285	1 E 21 D	81
1R1A-460-290	1 E 21 C	81
1R1A-480-330	1 F 26	93
1R1AF-390-295	1 E 21	80
1R1AF-415-285	1 E 21 D	81
1R1AF-460-290	1 E 21 C	81
1R1B-390-270	1 E 21-6	82
1R1B-415-270	1 E 21 E	82
1R1C-390-310	1 E 25	84
1R1CF-390-310	1 E 25	84
1R1D-355-355	1 E 32	88
1R1J-415-285	2 E 18 B	103
1R1J-520-285	2 E 18 A	103
1R1K-380-320	2 E 23 A	104
1R1K-440-320	2 E 23	103
1R1T-320-195	1 E 10 C	77
1R2A380-305	1 F 26 C	94
1R2A435-300	1 F 20 C	90
1R2A445-280	1 F 20 B	89
1R2A450-305	1 F 26 B-1	93
1R2A460-295	1 F 21	91
1R2D460-360	1 F 32 A	94
1R2D530-360	1 F 32 B	95
1R3M-340-340	1 E 26	86
1R4R465-260	1 F 16	89
1R4U-346-240	1 E 18 C	78
1R5P345-290	2 G 20	105
1R5P410-290	2 G 20 A	105
1R7Z-440-290	1 KF 21-21	96
1R7Z-440-290	1 KF 21-22	97
1R7Z-440-290-B	1 KF 21-1 NP	95
1R7Z-440-290-C	1 KF 21-2 NP	96
1R7Z-460-305-A	1 KF 24-1 NP	97
1R7Z-460-305-A	1 KF 24-21	98
1R7Z-460-305-B	1 KF 24-2 NP	98
1R7Z-460-305-B	1 KF 24-29	98
1T15AA-3	1 DK 18 A-1	54

Firestone Style	PHOENIX	
1T15L-4	1 DF 20 C-1	36
1T15L-4(3)	1 DF 23 B-2	44
1T15L-6	1 D 23 C-1	18
1T15LLR-5	1 DF 17 B-3	31
1T15LMR-3	1 DF 20 C-4	37
1T15LNR-3	1 DF 20 E-1	38
1T15LNR-4.5	1 DF 20 G-1	39
1T15LNR-4.5	1 DF 20 G-2	40
1T15LNR-4.5	1 DF 20 G-3	40
1T15LNR-4.5	1 DF 20 G-4	41
1T15LNR-6	1 DF 20 D-1	37
1T15LP-3	1 DK 18 A-1	54
1T15LR-4	1 DF 20 A-2	34
1T15M-3	1 DK 23 F-1	67
1T15M-4	1 DF 23 B-1	44
1T15M-6	1 DK 23 K-1	67
1T15M-6	1 DK 23 K-28	68
1T15M-6	1 DK 23 K-9082	68
1T15M-9	1 D 23 E-3	18
1T15M-9	1 DK 21 B-4	58
1T15M-9	1 DK 21 B-5 NP	59
1T15M-9	1 DK 23 L-25	70
1T15M-9	1 DK 23 L-27	70
1T15M-9	1 DK 23 L-31	70
1T15M-9	1 DK 23 L-9131	71
1T15MMW-10.5	1 DK 23 L-1	69
1T15MMW-10.5	1 DK 23 L-1 NP	69
1T15MPW-7	1 DK 20 A-1	54
1T15MPW-7	1 DK 20 A-51	55
1T15MPW-7	1 DK 20 C-2	56
1T15MPW-7	1 DK 21 A-3	57
1T15MPW-7	1 DK 21 A-31	57
1T15MPW-7	1 DK 21 A-4	57
1T15MPW-9	1 DK 20 B-1	55
1T15MPW-9	1 DK 20 B-1 NP	55
1T15MPW-9	1 DK 23 L-1	69
1T15UR	1 DF 17 A-2	30
1T15UR	1 DF 17 B-4	31
1T15UR-4.0	1 DF 17 C-1	32
1T15UR-4.0	1 DF 17-1	32
1T15UR-6	1 DF 17 A-1	30
1T15UR-9	1 DF 17 B-1	30
1T15UR-9	1 DF 17 B-2	31

ohne Gewähr | without engagement | sans garantie | sin garantia | без участия | bez gwarancji



Firestone Style	PHOENIX	
1T15VPR-3	1 DF 23 A-1	42
1T17-ACR-3.5	1 DF 25 A-30	49
1T17-ACR-3.5	1 DF 25 A-31	50
1T17AR-3.0	1 DF 25 A-1	47
1T17AR-3.0	1 DF 25 A-11	47
1T17AR-3.0	1 DF 25 A-2	48
1T17AR-4.5	1 DF 23 A-4	43
1T17AR-4.5	1 DF 25-1 NP	51
1T17AR-4.5	1 DF 25-11	52
1T17AR-4.5	1 DF 25-13	52
1T17AR-4.5	1 DF 25-14	52
1T17AR-4.5	1 DF 25-15	53
1T17AR-4.5	1 DF 25-3 NP	53
1T17ARD-3	1 DF 23 B-4	45
1T17B-11	1 DK 25-1	71
1T17BR-8	1 DF 22 C-1	42
1T17BS-6	1 DK 22 E-11	63
1T17BS-6	1 DK 22 E-5	65
1T17BS-6	1 DK 22 E-8	66
1T17BS-6	1 DK 22 E-9	66
1T17BS-6	1 DK 22 E-9 NP	66
1T17BUZ-6	1 DK 22 E-14	64
1T17CL9.5	1 DK 25-1	71
1T17D	1 DK 21 C-4	59
1T17D-4.3	1 DK 21 K	60
1T17D-4.3	1 DK 21 K-1	60
1T17D-4.3	1 DK 21 K-2	60
1T17D-8.3	1 DK 21	56
1T17D-8.3	1 DK 21-1	62
1T17D-8.3	1 DK 21-2	62
1T17DJ-6	1 DK 22 E-17	65
1T17DJ-7	1 DK 22 D-1	63
1T17HR-8	1 DF 23 G-1	46
1T17J-10.3	1 DK 21-2	62
1T17J-11.8	1 DK 21-4	62
1T17J-7.8	1 DK 21 K-4	61
1T17JBR-8.0	1 DF 19 B-1	32
1T17JBR-8.0	1 DF 19 B-1 NP	33
1T17JR-7.2	1 DF 19 B-1	32
1T17TWCR-8.0	1 DF 16-2	29
1T17TWCR-8.0	1 DF 16-2 NP	29
1T17TWR-8	1 DF 16-2	29
1T19F-14	1 D 28 H-16 NP	27

Firestone Style	PHOENIX	
1T19FB-11	1 D 28 B-11	22
1T19FB-15	1 D 28 D-11	24
1T19FB-8	1 D 28 E-2	25
1T19L-11	1 D 28 B-10	21
1T19L-11	1 D 28 B-10 NP	21
1T19L-11	1 D 28 B-12	22
1T19L-11	1 D 28 B-2	22
1T19L-11	1 D 28 B-4	23
1T19L-11	1 D 28 B-5 NP	23
1T19L-11	1 D 28 B-9	23
1T19L-11	1 D 28 F-5	26
1T19L-11	1 DK 28 B-7	71
1T19L-11	1 DK 28 F-3	72
1T19L-12	1 D 28 C-12	24
1T19L-12	1 D 28 F-1	26
1T19L-14	1 D 28 D-10	24
1T19L-14	1 D 28 D-2	25
1T19L-14	1 D 28 H-16	27
1T19L-14	1 D 28 H-16 NP	27
1T19L-14	1 DK 28 D-3	72
1T19L-14	1 DK 28 F-4	72
1T19L-7	1 D 28 A-10	19
1T19L-7	1 D 28 A-12	20
1T19L-7	1 D 28 A-13	20
1T19L-7	1 D 28 A-2	20
1T19L-7	1 D 28 A-5 NP	21
1T19LAJ-14	1 D 28 H-16	27
1T19LB-8	1 D 28 E-1	25
1T19LL-14	1 DK 28 F-5	73
1T19LL-14	1 DK 28 F-6	73
1T19LLJ-14	1 D 28 H-17	28
1T66D-10.8	1 DK 32	74
1T66D-13.5	1 DK 32 L	75
1T66D-7	1 DK 32 K	74
1T66E-10.8	1 DF 32-1	53
1T66E-13.8	1 DK 32 E-4	74
1T66F-10.8	1 DK 32-1	76
1T66F-10.8	1 DK 32-2	76
1T66F-13.5	1 DK 32 L-1	76
1T66F-7.0	1 DK 32 K-1	75
1T66F-7.0	1 DK 32 K-2	75
1T66G13.8	1 DK 32 E-4	74
20	2 B 12 R	100

ohne Gewähr | without engagement | sans garantie | sin garantia | без участия | bez gwarancji

Firestone Style	PHOENIX	
20	2 B 20 R	100
20	SP 2 B 12 R	108
20C-2	SP 2 B 12 R-A-10	109
20F	SP 2 B 12 R-17	109
20F	SP 2 B 12 R-5	109
26	2 B 07 R	100
2R2A460-295	1 F 21 C-5	92
C01-M58-1093	1 DK 23 L-2	69
C01-M58-1173	1 D 28 D-11	24



ohne Gewähr | without engagement | sans garantie | sin garantia | без участия | bez gwarancji





Gart No.	PHOENIX	
276.0.370	1 F 21 A	92
276.0.390	1 E 21	80
276.0.420	1 E 21 C	81
276.1.330	1 DF 17 C-1	32
276.1.331	1 DF 17-1	32
277.1.421	1 D 28 E-2	25
277.2.422	1 D 28 A-13	20
277.2.500	1 DK 28 B-7	71
277.4.420	1 D 28 A-2	20
277.4.423	1 D 28 A-10	19
277.4.424	1 D 28 E-1	25
277.4.500	1 D 28 B-2	22
277.4.505	1 D 28 B-10	21
277.4.505/1	1 D 28 A-10	19
277.4.520	1 D 28 B-12	22
277.4.524	1 D 28 B-12	22
278.0.430	2 E 23	103
278.0.452	1 DK 22 E-9 NP	66
278.0.531	1 DK 20 B-1 NP	55
278.0.551	1 DK 21 B-5 NP	59
278.1.452	1 DK 22 E-14	64
278.1.453	1 DK 22 E-13	64
278.1.455	1 DK 22 E-11	63
278.1.510	1 DK 23 L-9131	71
278.1.530	1 DK 20 B-1	55
278.1.530/1	1 DK 20 B-1	55
278.2.300	1 DF 23 B-1	44
278.2.300/1	1 DF 23 B-4	45
278.2.330	1 DF 23 A-1	42
278.2.330/1	1 DF 23 A-2	43
278.2.415	1 DF 23 C-1	45
278.2.500	1 DF 23 D-1	46
278.2.511	1 DK 23 L-25	70
278.4.421/1	1 DK 23 K-28	68
278.4.451	1 DK 22 E-5	65
278.4.452	1 DK 22 E-8	66
278.4.453	1 DK 22 E-9	66
278.4.454	1 DK 22 E-9	66
278.4.511/1	1 DK 23 L-27	70
278.4.511/2	1 DK 21 B-4	58
278.4.535	1 DK 25-1	71
282.0.460	1 KF 32-23 NP	99
282.0.461	1 KF 32-23 NP	99

Gart No.	PHOENIX	
282.1.460	1 KF 32-23	99
282.1.461	1 KF 32-23	99
282.1.600	1 D 28 H-16	27
286.0.420	1 E 21 D	81
287.0.603	1 D 28 H-16 NP	27
287.1.510	1 D 28 B-11	22
287.1.600	1 DK 28 F-4	72
287.1.602	1 DK 28 F-6	73
287.1.603	1 DK 28 F-5	73
287.1.606	1 D 28 H-16	27
287.2.510	1 DK 28 B-7	71
287.2.580	1 DK 28 B-7	71
287.4.510	1 D 28 B-2	22
287.4.512	1 D 28 B-4	23
287.4.520	1 D 28 B-9	23
287.4.521	1 D 28 B-12	22
287.4.540	1 D 28 F-1	26
287.4.580	1 D 28 C-12	24
287.4.581	1 DK 28 D-3	72
287.4.600	1 D 28 D-2	25
287.4.601	1 D 28 D-10	24
287.4.601/1	1 D 28 D-10	24
289.0.360	2 F 18	104
289.0.400	1 F 16	89
289.0.450	1 F 20 B	89
289.0.455	1 F 21 C-5	92
289.0.512	1 DF 16-2 NP	29
289.1.510	1 DF 16-2	29
290.0.390	1 E 21-6	82
290.0.392	1 DF 20 G-1 NP	39
290.0.393	1 DF 20 G-2 NP	40
290.0.394	1 DF 20 G-3 NP	41
290.0.395	1 DF 20 G-4 NP	41
290.0.420	1 F 20 A	89
290.0.440	1 E 21 E	82
290.1.390	1 DF 20 G-1	39
290.1.391	1 DF 20 G-2	40
290.1.392	1 DF 20 G-3	40
290.1.393	1 DF 20 G-4	41
291.2.200	SP 2 B 12 R	108
291.2.203	SP 2 B 12 R-5	109
291.2.260	SP 2 B 12 R-A-10	109
291.2.263	SP 2 B 12 R-A-3	110

ohne Gewähr | without engagement | sans garantie | sin garantia | без участия | bez gwarancji





Gart No.	PHOENIX	
292.0.450	1 F 32 A	94
292.0.461	1 DK 32 K	74
292.0.520	1 F 32 B	95
292.0.531	1 DK 32	74
292.0.601	1 DK 32 L	75
292.1.533	1 DF 32-1	53
292.2.460	1 DK 32 K-1	75
292.2.462	1 DK 32 K-2	75
292.2.530	1 DK 32-1	76
292.2.532	1 DK 32-2	76
292.2.600	1 DK 32 L-1	76
293.0.411	1 DK 21 K	60
293.0.412	1 DK 21 K-3	61
293.0.461	1 DF 22 C-1 NP	42
293.0.511	1 DK 21	56
293.1.460	1 DF 22 C-1	42
293.2.410	1 DK 21 K-1	60
293.2.412	1 DK 21 K-2	60
293.2.510	1 DK 21-1	62
293.2.512	1 DK 21-2	62
294.1.370	1 DF 20 E-1	38
294.1.430	1 DF 20 D-1	37
294.1.450	1 DK 20 A-51	55
294.1.451	1 DK 20 A-1	54
294.1.452	1 DK 20 C-2	56
294.1.500	1 DK 23 L-1	69
294.1.530	1 DK 19-1	54
294.2.450	1 DK 21 A-31	57
294.2.450/1	1 DK 21 A-3	57
294.2.451	1 DK 21 A-4	57
294.2.454	1 DK 21 C-4	59
294.2.460	1 DK 22 D-1	63
295.1.400	1 DF 17 A-1	30
295.1.465	1 DF 17 B-1	30
295.1.475/1	1 DF 17 B-2	31
296.0.360	1 E 14	77
297.0.390	1 E 25	84
297.1.300	1 DF 23 B-2	44
297.1.300/1	1 DF 23 B-5	45
297.1.430	1 DF 20 A-3	34
297.1.430/1	1 DF 20 A-5	35
297.1.431	1 DF 20 A-2	34
297.1.431/1	1 DF 20 A-6	35

Gart No.	PHOENIX	
297.1.432	1 DF 20 A-4	34
297.1.432/1	1 DF 20 A-8	36
297.2.315	1 DF 20 C-1	36
297.2.315/1	1 DF 20 C-2	37
299.0.450	1 F 21	91
299.0.460	1 KF 24-2 NP	98
299.0.461	1 KF 24-1 NP	97
299.1.460	1 KF 24-29	98
299.1.461	1 KF 24-21	98
302.0.376	1 DF 25-1 NP	51
302.0.376/2	1 DF 25-3 NP	53
302.1.375	1 DF 25-11	52
302.1.375/2	1 DF 25-13	52
304.0.440	1 KF 21-1 NP	95
304.0.441	1 KF 21-2 NP	96
304.0.490	1 F 21 D	93
304.0.511	1 DF 19 B-1 NP	33
304.1.440	1 KF 21-21	96
304.1.441	1 KF 21-22	97
304.1.510	1 DF 19 B-1	32
305.0.320	1 E 10 C	77

ohne Gewähr | without engagement | sans garantie | sin garantia | без участия | bez gwarancji



Gart Ref.	PHOENIX	
C282/C	1 KF 32-23	99
C282/C	1 KF 32-23 NP	99
C282/H	1 D 28 H-16	27
C289/C	1 F 20 B	89
C289/C1	1 F 21 C-5	92
C289/D	1 F 16	89
C289/M	1 DF 16-2	29
C289/M	1 DF 16-2 NP	29
C292	1 DK 32	74
C292	1 DK 32-1	76
C292	1 DK 32-2	76
C292/A	1 DK 21 K-3	61
C292/A	1 DK 32 K	74
C292/A	1 DK 32 K-1	75
C292/A	1 DK 32 K-2	75
C292/B	1 DK 32 L	75
C292/B	1 DK 32 L-1	76
C292/D	1 F 32 A	94
C292/E	1 F 32 B	95
C292/S	1 DF 32-1	53
C293	1 DK 21	56
C293	1 DK 21-1	62
C293	1 DK 21-2	62
C293/A	1 DK 21 K	60
C293/A	1 DK 21 K-1	60
C293/A	1 DK 21 K-2	60
C293/V	1 DF 22 C-1	42
C293/V	1 DF 22 C-1 NP	42
C294	1 DK 20 A-1	54
C294	1 DK 20 A-51	55
C294	1 DK 20 C-2	56
C294	1 DK 21 A-3	57
C294	1 DK 21 A-31	57
C294	1 DK 21 A-4	57
C294/C	1 DK 19-1	54
C294/D	1 DK 21 C-4	59
C294/HS	1 DK 23 L-1	69
C294/R	1 DK 22 D-1	63
C294/V	1 DF 20 D-1	37
C294/VA	1 DF 20 E-1	38
C295/SC	1 DF 17 B-2	31
C295/V	1 DF 17 B-1	30
C295/VA	1 DF 17 A-1	30

Gart Ref.	PHOENIX	
C298/E	2 F 18	104
C299	1 F 21	91
C299/A	1 KF 24-1 NP	97
C299/A	1 KF 24-2 NP	98
C299/A	1 KF 24-21	98
C299/A	1 KF 24-29	98
C302	1 DF 25-1 NP	51
C302	1 DF 25-11	52
C302	1 DF 25-13	52
C302	1 DF 25-3 NP	53
C304	1 KF 21-1 NP	95
C304	1 KF 21-2 NP	96
C304	1 KF 21-21	96
C304	1 KF 21-22	97
C304/B	1 F 21 D	93
C304/M4	1 DF 19 B-1	32
C304/M4	1 DF 19 B-1 NP	33
D276	1 E 21 C	81
D276/B	1 E 21	80
D276/C	1 F 21 A	92
D276/ER	1 DF 17 C-1	32
D276/ER	1 DF 17-1	32
D277	1 D 28 A-10	19
D277	1 D 28 B-10	21
D277/2F	1 DK 28 B-7	71
D277/B	1 D 28 A-10	19
D277/B	1 D 28 A-13	20
D277/B	1 D 28 A-2	20
D277/B	1 D 28 B-2	22
D277/B	1 D 28 E-1	25
D277/B	1 D 28 E-2	25
D277/D	1 D 28 B-12	22
D278	2 E 23	103
D278/D	1 DK 25-1	71
D278/G	1 DK 23 K-28	68
D278/H	1 DK 21 B-4	58
D278/H	1 DK 21 B-5 NP	59
D278/H	1 DK 23 L-25	70
D278/H	1 DK 23 L-27	70
D278/H	1 DK 23 L-9131	71
D278/HS	1 DK 20 B-1	55
D278/HS	1 DK 20 B-1 NP	55
D278/M	1 DF 23 D-1	46

ohne Gewähr | without engagement | sans garantie | sin garantia | без участия | bez gwarancji

Gart Ref.	PHOENIX	
D278/MA	1 DF 23 C-1	45
D278/N	1 DF 23 A-1	42
D278/N	1 DF 23 A-2	43
D278/NA	1 DF 23 B-1	44
D278/NA	1 DF 23 B-4	45
D278/S	1 DK 22 E-11	63
D278/S	1 DK 22 E-13	64
D278/S	1 DK 22 E-14	64
D278/S	1 DK 22 E-5	65
D278/S	1 DK 22 E-8	66
D278/S	1 DK 22 E-9	66
D278/S	1 DK 22 E-9 NP	66
D286	1 E 21 D	81
D287	1 D 28 B-12	22
D287	1 D 28 B-9	23
D287/A	1 D 28 B-11	22
D287/A	1 D 28 B-2	22
D287/A	1 D 28 B-4	23
D287/A	1 DK 28 B-7	71
D287/B	1 D 28 C-12	24
D287/B	1 DK 28 B-7	71
D287/B	1 DK 28 D-3	72
D287/C	1 D 28 D-10	24
D287/C	1 D 28 D-2	25
D287/C	1 DK 28 F-4	72
D287/C	1 DK 28 F-5	73
D287/C	1 DK 28 F-6	73
D287/E	1 D 28 F-1	26
D287/H	1 D 28 H-16	27
D287/H	1 D 28 H-16 NP	27
D290	1 E 21 D	81
D290	1 F 20 A	89
D290/B	1 E 21-6	82
D290/BR	1 DF 20 G-1	39
D290/BR	1 DF 20 G-1 NP	39
D290/BR	1 DF 20 G-2	40
D290/BR	1 DF 20 G-2 NP	40
D290/BR	1 DF 20 G-3	40
D290/BR	1 DF 20 G-3 NP	41
D290/BR	1 DF 20 G-4	41
D290/BR	1 DF 20 G-4 NP	41
D290/C	1 E 21 E	82
D296/C	1 E 14	77

Gart Ref.	PHOENIX	
D297	1 E 25	84
D297/A	1 DF 20 C-1	36
D297/A	1 DF 20 C-2	37
D297/B	1 DF 20 A-2	34
D297/B	1 DF 20 A-3	34
D297/B	1 DF 20 A-4	34
D297/B	1 DF 20 A-5	35
D297/B	1 DF 20 A-6	35
D297/B	1 DF 20 A-8	36
D297/C	1 DF 23 B-2	44
D297/C	1 DF 23 B-5	45
D305	1 E 10 C	77
T291/2	SP 2 B 12 R	108
T291/2	SP 2 B 12 R-5	109
T291/2B	SP 2 B 12 R-A-10	109
T291/2B	SP 2 B 12 R-A-3	110





Goodyear	PHOENIX	
1R10-702	1 DF 16-2 NP	29
1R10-704	1 DF 17 B-1	30
1R10-707	1 DF 17 A-1	30
1R10-709	1 DF 16-2	29
1R11-106	1 DK 21 A-31	57
1R11-111	1 DK 21 A-4	57
1R11-173	1 DF 20 A-4	34
1R11-173	1 DF 20 A-8	36
1R11-184	1 DF 20 A-3	34
1R11-184	1 DF 20 A-5	35
1R11-185	1 DF 20 A-2	34
1R11-185	1 DF 20 A-6	35
1R11-186	1 DF 20 A-1	33
1R11-186	1 DF 20 A-7	35
1R11-187	1 DF 23 B-2	44
1R11-187	1 DF 23 B-5	45
1R11-700	1 DK 21	56
1R11-703	1 DK 21 K	60
1R11-706	1 DK 22 E-5	65
1R11-710	1 DK 22 E-9	66
1R11-713	1 DK 22 E-8	66
1R11-714	1 DK 22 E-9	66
1R11-743	1 DK 21-2	62
1R11-750	1 DK 22 E-8	66
1R11-751	1 DK 22 E-9	66
1R11-752	1 DK 21 K-2	60
1R11-755	1 DF 20 C-1	36
1R11-755	1 DF 20 C-2	37
1R11-762	1 DK 21-1	62
1R11-763	1 DK 21 K-1	60
1R11-764	1 DK 20 A-1	54
1R11-772	1 DK 20 A-51	55
1R11-773	1 DK 20 C-2	56
1R11-781	1 DK 22 E-11	63
1R11-801	1 DK 21 K-3	61
1R11-805	1 DF 20 D-1	37
1R11-820	1 DF 19 B-1 NP	33
1R11-822	1 DK 18 A-1	54
1R11-823	1 DK 21 K-32	61
1R11-826	1 DK 18 A-1	54
1R11-829	1 DF 20 A-3	34
1R11-830	1 DF 20 A-2	34
1R11-831	1 DF 20 A-1	33

Goodyear	PHOENIX	
1R11-832	1 DF 20 A-4	34
1R11-833	1 DF 20 C-1	36
1R11-834	1 DF 20 A-5	35
1R11-837	1 DF 20 C-2	37
1R11-838	1 DF 20 A-8	36
1R11-839	1 DF 20 A-7	35
1R11-840	1 DF 20 A-6	35
1R11-841	1 DF 23 B-5	45
1R11-843	1 DF 17 B-3	31
1R11-845	1 DF 23 B-2	44
1R11-848	1 DF 20 E-1	38
1R11-850	1 DK 22 E-9 NP	66
1R11-858	1 DF 20 E-2	38
1R11-861	1 DF 19 B-1	32
1R11-862	1 DF 20 A-9	36
1R11-865	1 DF 20 A-10	33
1R11-866	1 DK 21 A-3	57
1R11-867	1 DF 20 A-9	36
1R11-869	1 DF 20 A-10	33
1R11-871	1 DF 20 C-4	37
1R11-878	1 DK 21 A-4 NP	58
1R11-879	1 DF 20 C-4	37
1R11-882	1 DK 21 A-3	57
1R11-890	1 DF 17-1	32
1R11-896	1 DF 20 C-4	37
1R12-092	1 DK 23 K-9082	68
1R12-520	1 DF 23 A-1	42
1R12-520	1 DF 23 A-2	43
1R12-521	1 DF 23 A-3	43
1R12-700	1 DF 25-1 NP	51
1R12-701	1 DK 23 L-27	70
1R12-702	1 DK 23 L-25	70
1R12-703	1 D 23 E-3	18
1R12-709	1 D 23 C-1	18
1R12-710	1 DF 25-3 NP	53
1R12-711	1 DF 25-13	52
1R12-712	1 DF 25-11	52
1R12-713	1 DK 23 L-31	70
1R12-719	1 DK 23 K-28	68
1R12-720	1 D 23 E-2	18
1R12-721	1 DK 23 L-9131	71
1R12-748	1 DK 20 B-1 NP	55
1R12-749	1 DK 20 B-1	55

ohne Gewähr | without engagement | sans garantie | sin garantia | без участия | bez gwarancji





Goodyear	PHOENIX	
1R12-760	1 DK 21 B-4	58
1R12-761	1 DK 21 B-5 NP	59
1R12-762	1 DF 22 C-1	42
1R12-763	1 DF 22 C-1 NP	42
1R12-768	1 DF 25-15	53
1R12-801	1 DF 25 B-1 NP	50
1R12-809	1 DF 23 A-1	42
1R12-811	1 DF 25 B-1 NP	50
1R12-813	1 DF 23 A-2	43
1R12-814	1 DF 23 A-3	43
1R12-823	1 DF 25 C-1	51
1R12-824	1 DF 25 C-1 NP	51
1R12-825	1 DF 25 C-1	51
1R12-826	1 DF 25 C-1 NP	51
1R12-834	1 DK 21 B-4	58
1R12-837	1 DK 23 L-1	69
1R12-840	1 DK 23 L-1 NP	69
1R12-842	1 DK 23 K-1 NP	68
1R12-849	1 DF 23 A-4	43
1R13-148	1 DK 25-1	71
1R13-150	1 DK 25-1	71
1R13-160	1 DF 23 B-1	44
1R13-199	1 DF 23 C-1	45
1R13-200	1 DF 23 D-1	46
1R13-732	1 DK 28 D-3	72
1R13-734	1 D 28 C-12	24
1R13-738	1 DK 28 F-4	72
1R13-744	1 DF 23 C-1	45
1R13-745	1 DF 23 D-1	46
1R13-746	1 DF 23 B-1	44
1R13-750	1 DF 23 B-4	45
1R13-752	1 DF 23 B-4	45
1R13-753	1 DK 28 F-5	73
1R13-754	1 DF 23 B-4	45
1R13-803	1 DK 28 D-3	72
1R13-805	1 D 28 C-12	24
1R14-700	1 DK 32 L	75
1R14-701	1 DK 32 K	74
1R14-705	1 D 28 B-2	22
1R14-706	1 DK 28 B-7	71
1R14-708	1 DK 32	74
1R14-709	1 D 28 B-4	23
1R14-710	1 D 28 B-12	22

Goodyear	PHOENIX	
1R14-712	1 DK 32-1	76
1R14-716	1 D 28 A-2	20
1R14-721	1 D 28 B-12	22
1R14-724	1 DK 32 K-1	75
1R14-727	1 D 28 B-9	23
1R14-728	1 D 28 D-10	24
1R14-729	1 D 28 B-10	21
1R14-730	1 D 28 A-10	19
1R14-748	1 DK 32-2	76
1R14-753	1 D 28 H-16	27
1R14-755	1 D 28 H-16 NP	27
1R14-757	1 DK 32 K-2	75
1R14-758	1 D 28 D-2	25
1R14-781	1 DK 32 L-1	76
1R14-782	1 D 28 F-1	26
1R14-783	1 D 28 A-12	20
1R14-784	1 D 28 F-5	26
1R14-809	1 DK 32 E-4	74
1R14-810	1 D 28 F-1	26
1R14-812	1 D 28 F-5	26
1R14-814	1 DF 32-1	53
1R14-815	1 D 28 B-11	22
1R14-819	1 DK 28 F-3	72
1R14-820	1 D 28 A-2	20
1R14-823	1 DK 28 F-3	72
1R14-824	1 D 28 A-2	20
1R14-825	1 D 28 A-13	20
1R14-857	1 D 28 B-2	22
1R14-867	1 D 28 B-5 NP	23
1R14-868	1 D 28 A-5 NP	21
1R14-869	1 D 28 H-17	28
2B12-425/300	2 B 20 R	100
2B9-223	SP 2 B 12 R	108
2B9-234	SP 2 B 12 R-17	109
2B9-269	SP 2 B 12 R-A-10	109
2B9-700	SP 2 B 12 R-5	109
2B9-701	SP 2 B 12 R-A-3	110
2B9-8325	2 B 12 R	100
8017	1 E 21	80
8018	1 E 25	84
8028	2 E 23	103
8037	2 E 18 B	103
8040	2 E 18 A	103

ohne Gewähr | without engagement | sans garantie | sin garantia | без участия | bez gwarancji



Goodyear	PHOENIX	
8042	2 E 23 A	104
8053	1 E 18	78
8117	1 F 32 A	94
8118	1 F 32 B	95
8313	2 E 23	103
9002	1 F 20 A	89
9003	1 F 20 B	89
9004	2 G 20	105
9005	2 G 20 A	105
9006	1 E 26	86
9007	1 E 32	88
9008	1 F 21	91
9009	1 E 21-6	82
9011	1 E 26 A	86
9012	1 F 21 C-2	92
9013	1 E 21 D	81
9014	1 E 21 C	81
9015	1 F 21 C-5	92
9043	1 E 18 D	79
9048	1 F 16	89
9050	1 E 23	83
9051	1 F 21 A	92
9066	1 F 21 D	93
9073	1 F 26 B-1	93
9074	1 F 26 D	94
9075	1 F 26	93
9077	1 F 26 C	94
9080	1 E 18 D	79
9081	1 E 21 B	81
9082	1 E 18 E	80
9106	1 E 21 E	82
9112	1 E 18 C	78
9113	1 E 23 A	83
9123	1 E 25 B	85
9131	1 E 21 F	82
9133	1 E 18 C	78
9134	1 E 21 F	82
9500	1 E 26-1	88
9501	1 E 18 D-01	79
9502	1 E 18 D-02	79
9505	1 KF 21-1	95
9505	1 KF 21-21	96
9506	1 KF 21-2	96

Goodyear	PHOENIX	
9506	1 KF 21-22	97
9507	1 KF 21-1 NP	95
9508	1 KF 21-2 NP	96
9513	1 E 18 D-03	80
9517	1 KF 24-1 NP	97
9518	1 KF 24-2 NP	98
9519	1 KF 24-1	97
9519	1 KF 24-21	98
9520	1 KF 24-29	98
9520	1 KF 24-9	99
9529	1 E 26-1	88
9553	1 E 18 D-01	79
9562	1 E 23 A-1	83
ex 1R13-711	1 DK 28 F-4	72

ohne Gewähr | without engagement | sans garantie | sin garantia | без участия | bez gwarancji

Neotec	PHOENIX	
AB 314	2 E 18 B	103
AB 314 L	2 E 18 A	103
AB 414 S	1 E 18	78
AB 414 SL	1 E 18 D	79
AB 415	1 F 20 B	89
AB 415 L	1 F 21 C-2	92
AB 415 S	1 F 20 A	89
AB 416	1 E 26	86
AB 418	1 E 26 A	86
AB 430	1 F 26 C	94
AB 432	1 F 26 B-1	93
AB 434 B	1 F 26	93
AB 434 L	1 F 26 D	94
AB 443	1 F 16	89
AB 445	1 E 21-6	82
AB 445 A	1 E 21-6	82
AB 445 L	1 E 21 D	81
AB 445 SN	1 E 21 B	81
AB 445 XL	1 E 21 C	81
AB 455	1 F 21	91
AB 455 A	1 F 21 C-5	92
AB 455 L	1 F 21 D	93
AB 455 S	1 F 21 A	92
AB 525	2 G 20	105
AB 526	2 F 18	104
AB 528	2 G 20 A	105
AB 538	1 E 32	88
AB 545	1 F 32 A	94
AB 545 L	1 F 32 B	95
AB 640	2 E 23 A	104
AB 640 L	2 E 23	103
AB 888	1 E 25	84
AB 889	1 E 25 B	85
ABK 414 SL	1 E 18 D-01	79
ABK 414 SL A	1 E 18 D-02	79
ABM 206 33 A 01	1 DF 23 B-3	44
ABM 208 33 A 02	1 DF 23 C-1	45
ABM 210 33 A 03	1 DF 23 D-1	46
ABM 212 25 A 05	1 DF 17 C-1	32
ABM 212 26 E 08	1 DF 17-1	32
ABM 214 25 A 01	1 DF 17 A-1	30
ABM 216 25 A 02	1 DF 17 B-1	30
ABM 216 28 B 02	1 DF 17 B-3	31

Neotec	PHOENIX	
ABM 218 29 A 03	1 DF 20 E-1	38
ABM 220 29 A 04	1 DF 20 D-1	37
ABM 222 32 A 01	1 DK 23 K-1	67
ABM 222 32 A 02	1 DK 23 K-28	68
ABM 222 32 B 08	1 DK 23 K-9082	68
ABM 224 28 B 06	1 DF 20 C-1	36
ABM 224 28 C 06	1 DF 20 C-2	37
ABM 225 27 D 05	1 DK 18 A-1	54
ABM 226 28 B 01	1 DF 20 A-2	34
ABM 226 28 B 02	1 DF 20 A-1	33
ABM 226 28 B 02	1 DF 20 A-3	34
ABM 226 28 B 03	1 DF 20 A-4	34
ABM 226 28 C 01	1 DF 20 A-6	35
ABM 226 28 C 02	1 DF 20 A-5	35
ABM 226 28 C 03	1 DF 20 A-8	36
ABM 226 28 C 04	1 DF 20 A-7	35
ABM 234 28 A	1 DF 20 G-1 NP	39
ABM 234 28 A 01	1 DF 20 G-1	39
ABM 234 28 A 11	1 DF 20 G-1	39
ABM 234 28 B	1 DF 20 G-2 NP	40
ABM 234 28 B 01	1 DF 20 G-2	40
ABM 234 28 B 11	1 DF 20 G-2	40
ABM 234 28 C	1 DF 20 G-3 NP	41
ABM 234 28 C 01	1 DF 20 G-3	40
ABM 234 28 C 11	1 DF 20 G-3	40
ABM 234 28 D	1 DF 20 G-4 NP	41
ABM 234 28 D 01	1 DF 20 G-4	41
ABM 234 28 D 11	1 DF 20 G-4	41
ABM 237 27 F 09	1 DK 19-1	54
ABM 239 29 A	1 DK 23 L-1 NP	69
ABM 239 29 A 22	1 DK 23 L-1	69
ABM 242 32 A	1 DK 21 B-5 NP	59
ABM 242 32 A 03	1 DK 21 B-4	58
ABM 242 32 A 04	1 DK 23 L-25	70
ABM 242 32 A 05	1 DK 23 L-9131	71
ABM 242 32 A 07	1 DK 23 L-27	70
ABM 276 28 C 08	1 DF 20 A-10	33
ABM 502 28 A 03	1 DF 23 B-2	44
ABM 502 28 B 03	1 DF 23 B-5	45
ABM 504 32 A 02	1 DF 23 A-1	42
ABM 504 32 B 02	1 DF 23 A-2	43
ABM 506 31 D 01	1 DF 25 A-2	48
ABM 506 31 D 02	1 DF 25 A-1	47

ohne Gewähr | without engagement | sans garantie | sin garantia | без участия | bez gwarancji





Neotec	PHOENIX	
ABM 507 31 A	1 DF 25-1 NP	51
ABM 507 31 A 01	1 DF 25-11	52
ABM 507 31 A 02	1 DF 25-15	53
ABM 507 31 B 05	1 DF 25-14	52
ABM 507 31 C	1 DF 25-3 NP	53
ABM 507 31 C 01	1 DF 25-13	52
ABM 507 31 G 07	1 DF 23 A-4	43
ABM 520 30 A	1 DK 22 E-9 NP	66
ABM 520 30 A 00	1 DK 22 E-9	66
ABM 520 30 A 11	1 DK 22 E-11	63
ABM 520 30 A 12	1 DK 22 E-13	64
ABM 520 30 A 13	1 DK 22 E-14	64
ABM 520 30 B 00	1 DK 22 E-8	66
ABM 520 30 F 11	1 DK 22 E-16	65
ABM 522 33 A 01	1 DK 25-1	71
ABM 527 32 M	1 DF 25 C-1 NP	51
ABM 527 32 M 30	1 DF 25 C-1	51
ABM 530 30 A	1 DK 21 K	60
ABM 530 30 F	1 DK 21 K-3	61
ABM 535 30 D	1 DF 22 C-1 NP	42
ABM 535 30 D 10	1 DF 22 C-1	42
ABM 537 30 A 15	1 DK 21 C-4	59
ABM 537 30 C 20	1 DK 20 A-1	54
ABM 537 30 F 21	1 DK 20 C-2	56
ABM 537 30 F 22	1 DK 20 A-51	55
ABM 537 30 H 16	1 DK 21 A-31	57
ABM 539 29 A	1 DF 19 B-1 NP	33
ABM 539 29 A 02	1 DF 19 B-1	32
ABM 541 27 B	1 DF 16-2 NP	29
ABM 541 27 B 01	1 DF 16-2	29
ABM 550 30 A	1 DK 21	56
ABM 553 30 C	1 DK 20 B-1 NP	55
ABM 553 30 C 20	1 DK 20 B-1	55
ABM 722 34 35B	1 D 28 A-2	20
ABM 722 34 A	1 D 28 A-5 NP	21
ABM 722 34 A 35	1 D 28 A-2	20
ABM 722 34 C	1 D 28 A-10 NP	19
ABM 722 34 C 35	1 D 28 A-10	19
ABM 722 34 C 36	1 D 28 A-13	20
ABM 722 34 C 41	1 D 28 E-2	25
ABM 740 33 A	1 D 28 B-5 NP	23
ABM 740 33 A 45	1 D 28 B-2	22
ABM 740 33 B 45	1 D 28 B-2	22

Neotec	PHOENIX	
ABM 740 33 C	1 D 28 B-10 NP	21
ABM 740 33 C 45	1 D 28 B-10	21
ABM 740 33 D 45	1 D 28 B-9	23
ABM 740 33 E 45	1 D 28 B-9	23
ABM 740 35 C 61	1 D 28 B-11	22
ABM 742 33 B 45	1 D 28 B-12	22
ABM 742 33 C 45	1 D 28 F-1	26
ABM 742 34 A 47	1 D 28 C-12	24
ABM 742 35 C 38	1 DK 28 F-3	72
ABM 744 35 K 45	1 D 28 F-5	26
ABM 760 32 H 50	1 DK 28 F-4	72
ABM 760 33 C 49	1 D 28 D-11	24
ABM 760 34 A 47	1 D 28 D-2	25
ABM 760 34 C 47	1 D 28 D-10	24
ABM 771 33 K	1 D 28 H-16 NP	27
ABM 771 33 K 55	1 D 28 H-16	27
ABM 771 33 N 55	1 D 28 H-17	28
ABM 775 32 M 56	1 DF 23 G-1	46
ABM 930 36 A	1 DK 32 K	74
ABM 950 36 A	1 DK 32	74
ABM 950 36 B 63	1 DF 32-1	53
ABM 970 36 A	1 DK 32 L	75
ABV 247 A	1 KF 21-1 NP	95
ABV 247 A 02	1 KF 21-1	95
ABV 247 B 02	1 KF 21-2	96
ABV 247 D	1 KF 21-2 NP	96

ohne Gewähr | without engagement | sans garantie | sin garantia | без участия | bez gwarancji





Prime-Ride New	PHOENIX	
1R10-702	1 DF 16-2 NP	29
1R10-704	1 DF 17 B-1	30
1R10-707	1 DF 17 A-1	30
1R10-709	1 DF 16-2	29
1R10-718	1 DF 17 B-4	31
1R10-719	1 DF 17 A-2	30
1R11-106	1 DK 21 A-31	57
1R11-111	1 DK 21 A-4	57
1R11-173	1 DF 20 A-4	34
1R11-184	1 DF 20 A-3	34
1R11-184	1 DF 20 A-5	35
1R11-185	1 DF 20 A-2	34
1R11-185	1 DF 20 A-6	35
1R11-186	1 DF 20 A-1	33
1R11-187	1 DF 23 B-2	44
1R11-187	1 DF 23 B-5	45
1R11-700	1 DK 21	56
1R11-703	1 DK 21 K	60
1R11-706	1 DK 22 E-5	65
1R11-710	1 DK 22 E-9	66
1R11-713	1 DK 22 E-8	66
1R11-714	1 DK 22 E-9	66
1R11-743	1 DK 21-2	62
1R11-750	1 DK 22 E-8	66
1R11-751	1 DK 22 E-9	66
1R11-752	1 DK 21 K-2	60
1R11-755	1 DF 20 C-1	36
1R11-762	1 DK 21-1	62
1R11-763	1 DK 21 K-1	60
1R11-764	1 DK 20 A-1	54
1R11-772	1 DK 20 A-51	55
1R11-773	1 DK 20 C-2	56
1R11-781	1 DK 22 E-11	63
1R11-801	1 DK 21 K-3	61
1R11-805	1 DF 20 D-1	37
1R11-820	1 DF 19 B-1 NP	33
1R11-822	1 DK 18 A-1	54
1R11-823	1 DK 21 K-32	61
1R11-826	1 DK 18 A-1	54
1R11-829	1 DF 20 A-3	34
1R11-830	1 DF 20 A-2	34
1R11-831	1 DF 20 A-1	33
1R11-832	1 DF 20 A-4	34

Prime-Ride New	PHOENIX	
1R11-833	1 DF 20 C-1	36
1R11-834	1 DF 20 A-5	35
1R11-840	1 DF 20 A-6	35
1R11-841	1 DF 23 B-5	45
1R11-843	1 DF 17 B-3	31
1R11-845	1 DF 23 B-2	44
1R11-848	1 DF 20 E-1	38
1R11-850	1 DK 22 E-9 NP	66
1R11-858	1 DF 20 E-2	38
1R11-861	1 DF 19 B-1	32
1R11-862	1 DF 20 A-9	36
1R11-865	1 DF 20 A-10	33
1R11-866	1 DK 21 A-3	57
1R11-867	1 DF 20 A-9	36
1R11-869	1 DF 20 A-10	33
1R11-871	1 DF 20 C-4	37
1R11-878	1 DK 21 A-4 NP	58
1R11-879	1 DF 20 C-4	37
1R11-882	1 DK 21 A-3	57
1R11-890	1 DF 17-1	32
1R11-896	1 DF 20 C-4	37
1R11-915	1 DK 21 C-4	59
1R11-916	1 DF 20 G-3	40
1R11-917	1 DF 20 G-4	41
1R11-918	1 DF 20 G-1	39
1R11-919	1 DF 20 G-2	40
1R11-920	1 DF 20 G-3 NP	41
1R11-921	1 DF 20 G-4 NP	41
1R11-922	1 DF 20 G-1 NP	39
1R11-923	1 DF 20 G-2 NP	40
1R11-927	1 DK 22 E-17	65
1R11-932	1 DK 20 C-5	56
1R11-934	1 D 23 G-1	19
1R11-936	1 DK 22 E-16	65
1R11-937	1 DK 22 D-1	63
1R11-938	1 DK 21 C-5	59
1R11-939	1 DK 21 K-4	61
1R11-940	1 DK 21-4	62
1R11-941	1 DK 22 E-14	64
1R11-942	1 DK 22 E-13	64
1R11-946	1 DF 16 A-1	28
1R11-947	1 DF 16 A-2	29
1R11-948	1 DF 20 D-2	38

ohne Gewähr | without engagement | sans garantie | sin garantia | без участия | bez gwarancji





Prime-Ride New	PHOENIX	
1R11-949	1 DF 20 F-1	39
1R12-520	1 DF 23 A-1	42
1R12-520	1 DF 23 A-2	43
1R12-521	1 DF 23 A-3	43
1R12-700	1 DF 25-1 NP	51
1R12-701	1 DK 23 L-27	70
1R12-702	1 DK 23 L-25	70
1R12-703	1 D 23 E-3	18
1R12-709	1 D 23 C-1	18
1R12-710	1 DF 25-3 NP	53
1R12-711	1 DF 25-13	52
1R12-712	1 DF 25-11	52
1R12-713	1 DK 23 L-31	70
1R12-719	1 DK 23 K-28	68
1R12-720	1 D 23 E-2	18
1R12-721	1 DK 23 L-9131	71
1R12-748	1 DK 20 B-1 NP	55
1R12-749	1 DK 20 B-1	55
1R12-760	1 DK 21 B-4	58
1R12-761	1 DK 21 B-5 NP	59
1R12-762	1 DF 22 C-1	42
1R12-763	1 DF 22 C-1 NP	42
1R12-768	1 DF 25-15	53
1R12-801	1 DF 25 B-1 NP	50
1R12-809	1 DF 23 A-1	42
1R12-811	1 DF 25 B-1 NP	50
1R12-813	1 DF 23 A-2	43
1R12-814	1 DF 23 A-3	43
1R12-823	1 DF 25 C-1	51
1R12-824	1 DF 25 C-1 NP	51
1R12-825	1 DF 25 C-1	51
1R12-826	1 DF 25 C-1 NP	51
1R12-834	1 DK 21 B-4	58
1R12-837	1 DK 23 L-1	69
1R12-840	1 DK 23 L-1 NP	69
1R12-842	1 DK 23 K-1 NP	68
1R12-849	1 DF 23 A-4	43
1R12-922	1 DK 23 L-2	69
1R13-148	1 DK 25-1	71
1R13-150	1 DK 25-1	71
1R13-160	1 DF 23 B-1	44
1R13-199	1 DF 23 C-1	45
1R13-200	1 DF 23 D-1	46

Prime-Ride New	PHOENIX	
1R13-732	1 DK 28 D-3	72
1R13-734	1 D 28 C-12	24
1R13-738	1 DK 28 F-4	72
1R13-744	1 DF 23 C-1	45
1R13-745	1 DF 23 D-1	46
1R13-746	1 DF 23 B-1	44
1R13-750	1 DF 23 B-4	45
1R13-752	1 DF 23 B-4	45
1R13-753	1 DK 28 F-5	73
1R13-754	1 DF 23 B-4	45
1R13-772	1 DK 28 F-6	73
1R13-803	1 DK 28 D-3	72
1R13-805	1 D 28 C-12	24
1R14-700	1 DK 32 L	75
1R14-701	1 DK 32 K	74
1R14-705	1 D 28 B-2	22
1R14-706	1 DK 28 B-7	71
1R14-708	1 DK 32	74
1R14-709	1 D 28 B-4	23
1R14-710	1 D 28 B-12	22
1R14-712	1 DK 32-1	76
1R14-716	1 D 28 A-2	20
1R14-721	1 D 28 B-12	22
1R14-724	1 DK 32 K-1	75
1R14-727	1 D 28 B-9	23
1R14-728	1 D 28 D-10	24
1R14-729	1 D 28 B-10	21
1R14-730	1 D 28 A-10	19
1R14-748	1 DK 32-2	76
1R14-753	1 D 28 H-16	27
1R14-755	1 D 28 H-16 NP	27
1R14-757	1 DK 32 K-2	75
1R14-758	1 D 28 D-2	25
1R14-781	1 DK 32 L-1	76
1R14-782	1 D 28 F-1	26
1R14-783	1 D 28 A-12	20
1R14-784	1 D 28 F-5	26
1R14-809	1 DK 32 E-4	74
1R14-810	1 D 28 F-1	26
1R14-812	1 D 28 F-5	26
1R14-814	1 DF 32-1	53
1R14-819	1 DK 28 F-3	72
1R14-820	1 D 28 A-2	20

ohne Gewähr | without engagement | sans garantie | sin garantia | без участия | bez gwarancji





Prime-Ride New	PHOENIX	
1R14-823	1 DK 28 F-3	72
1R14-824	1 D 28 A-2	20
1R14-825	1 D 28 A-13	20
1R14-857	1 D 28 B-2	22
1R14-867	1 D 28 B-5 NP	23
1R14-868	1 D 28 A-5 NP	21
1R14-869	1 D 28 H-17	28
1R14-890	1 D 28 D-11	24
1R14-892	1 D 28 E-2	25
2B9-223	SP 2 B 12 R	108
2B9-234	SP 2 B 12 R-17	109
2B9-269	SP 2 B 12 R-A-10	109
2B9-700	SP 2 B 12 R-5	109
2B9-701	SP 2 B 12 R-A-3	110
2B9-703	SP 2 B 12 R-B-1	110
8017	1 E 21	80
8018	1 E 25	84
8028	2 E 23	103
8053	1 E 18	78
8117	1 F 32 A	94
9002	1 F 20 A	89
9003	1 F 20 B	89
9004	2 G 20	105
9005	2 G 20 A	105
9006	1 E 26	86
9007	1 E 32	88
9008	1 F 21	91
9009	1 E 21-6	82
9011	1 E 26 A	86
9012	1 F 21 C-2	92
9013	1 E 21 D	81
9014	1 E 21 C	81
9015	1 F 21 C-5	92
9048	1 F 16	89
9050	1 E 23	83
9051	1 F 21 A	92
9066	1 F 21 D	93
9073	1 F 26 B-1	93
9074	1 F 26 D	94
9075	1 F 26	93
9077	1 F 26 C	94
9080	1 E 18 D	79
9081	1 E 21 B	81

Prime-Ride New	PHOENIX	
9082	1 E 18 E	80
9106	1 E 21 E	82
9112	1 E 18 C	78
9113	1 E 23 A	83
9123	1 E 25 B	85
9131	1 E 21 F	82
9133	1 E 18 C	78
9134	1 E 21 F	82
9500	1 E 26-1	88
9502	1 E 18 D-02	79
9505	1 KF 21-1	95
9505	1 KF 21-21	96
9506	1 KF 21-2	96
9506	1 KF 21-22	97
9507	1 KF 21-1 NP	95
9508	1 KF 21-2 NP	96
9513	1 E 18 D-03	80
9517	1 KF 24-1 NP	97
9518	1 KF 24-2 NP	98
9519	1 KF 24-1	97
9519	1 KF 24-21	98
9520	1 KF 24-29	98
9520	1 KF 24-9	99
9529	1 E 26-1	88
9553	1 E 18 D-01	79
9562	1 E 23 A-1	83
ex 1R13-711	1 DK 28 F-4	72

ohne Gewähr | without engagement | sans garantie | sin garantia | без участия | bez gwarancji





Prime-Ride	PHOENIX	
21885 A	1 F 20 B	89
2415-25 A	2 G 20	105
2415-28 A	2 G 20 A	105
2450-25 A	1 E 23	83
2644 A	1 E 21	80
2661 A	1 E 25	84
2662 A	1 E 32	88
2673 A	1 F 21 A	92
2701 A	1 E 26	86
2713 A	1 F 21 D	93
2720 A	1 F 21	91
2727 A	1 F 32 A	94
2882 A	1 F 16	89
2884 A	1 F 20 A	89
2896 A	2 E 18 A	103
2897 A	2 E 23	103
2927 A	2 E 18 B	103
2928 A	2 E 23 A	104
5200-19 A P01	SP 2 B 12 R	108
54004 A P03	1 DK 22 E-8	66
54004 A P05	1 DK 22 E-5	65
54022 A P02	1 DK 22 E-9 NP	66
54022 A P03	1 DK 22 E-9	66
54022 A P05	1 DK 22 E-11	63
54023 A P03	1 D 28 B-10	21
54028 A P02	1 D 28 F-1	26
54028 A P05	1 D 28 B-12	22
54156 A P07	1 DK 23 K-28	68
54156 A P15	1 DK 23 K-1	67
54157 A P04	1 DK 21 C-4	59
54157 A P05	1 DK 21 A-3	57
54157 A P06	1 DK 20 A-1	54
54157 A P08	1 DK 20 C-2	56
54157 A P09	1 DK 21 A-31	57
54157 A P10	1 DK 20 A-51	55
54158 A P02	1 DK 20 B-1 NP	55
54158 A P03	1 DK 20 B-1	55
54159 A P03	1 DK 23 L-27	70
54159 A P05	1 DK 21 B-5 NP	59
54159 A P07	1 DK 23 L-25	70
54159 A P09	1 DK 23 L-9131	71
54159 A P14	1 DK 21 B-4	58
54159 A P16	1 DK 23 L-1	69

Prime-Ride	PHOENIX	
54390 A P01	1 KF 21-1	95
54390 A P02	1 KF 21-2	96
54390 A1	1 KF 21-1 NP	95
54390 A2	1 KF 21-2 NP	96
54713 A P02	1 DF 22 C-1	42
54810 A P01	1 D 28 A-10 NP	19
54810 A P05	1 D 28 A-10	19
54813 A P07	1 D 28 B-9	23
54881 A P02	1 DK 32 K	74
54881 A P03	1 DK 32 K-1	75
54881 A P04	1 DK 32 K-2	75
54912 A P07	1 DK 28 F-4	72
54913 A P02	1 D 28 H-16	27
54913 A P04	1 D 28 H-16 NP	27
56605 A P01	1 DF 20 D-1	37
56606 A P01	1 DF 20 E-1	38
56607 A P01	1 DF 17 A-1	30
56608 A P01	1 DF 17 B-1	30
5725 A P03	1 DF 32-1	53
5810 A P02	1 D 28 A-5 NP	21
5810 A P03	1 D 28 A-2	20
5813 A P02	1 D 28 B-5 NP	23
5813 A P03	1 D 28 B-2	22
5836 A1	1 DF 25-1 NP	51
5836 A1 P01	1 DF 25-11	52
5836 A2	1 DF 25-3 NP	53
5836 A2 P01	1 DF 25-13	52
5881 A P02	1 DK 32	74
5881 A P03	1 DK 32-1	76
5881 A P04	1 DK 32-2	76
5940 A P02	1 DK 21 K	60
5940 A P03	1 DK 21 K-1	60
5940 A P04	1 DK 21 K-2	60
5941 A P02	1 DK 21	56
5941 A P03	1 DK 21-1	62
5941 A P04	1 DK 21-2	62

ohne Gewähr | without engagement | sans garantie | sin garantia | без участия | bez gwarancji





Springride	PHOENIX	
1R10-702	1 DF 16-2 NP	29
1R10-704	1 DF 17 B-1	30
1R10-707	1 DF 17 A-1	30
1R10-709	1 DF 16-2	29
1R11-106	1 DK 21 A-31	57
1R11-111	1 DK 21 A-4	57
1R11-173	1 DF 20 A-4	34
1R11-184	1 DF 20 A-3	34
1R11-184	1 DF 20 A-5	35
1R11-185	1 DF 20 A-2	34
1R11-185	1 DF 20 A-6	35
1R11-186	1 DF 20 A-1	33
1R11-187	1 DF 23 B-2	44
1R11-187	1 DF 23 B-5	45
1R11-700	1 DK 21	56
1R11-703	1 DK 21 K	60
1R11-706	1 DK 22 E-5	65
1R11-710	1 DK 22 E-9	66
1R11-713	1 DK 22 E-8	66
1R11-714	1 DK 22 E-9	66
1R11-743	1 DK 21-2	62
1R11-750	1 DK 22 E-8	66
1R11-751	1 DK 22 E-9	66
1R11-752	1 DK 21 K-2	60
1R11-755	1 DF 20 C-1	36
1R11-762	1 DK 21-1	62
1R11-763	1 DK 21 K-1	60
1R11-764	1 DK 20 A-1	54
1R11-772	1 DK 20 A-51	55
1R11-773	1 DK 20 C-2	56
1R11-781	1 DK 22 E-11	63
1R11-801	1 DK 21 K-3	61
1R11-805	1 DF 20 D-1	37
1R11-820	1 DF 19 B-1 NP	33
1R11-822	1 DK 18 A-1	54
1R11-823	1 DK 21 K-32	61
1R11-826	1 DK 18 A-1	54
1R11-829	1 DF 20 A-3	34
1R11-830	1 DF 20 A-2	34
1R11-831	1 DF 20 A-1	33
1R11-832	1 DF 20 A-4	34
1R11-833	1 DF 20 C-1	36
1R11-834	1 DF 20 A-5	35

Springride	PHOENIX	
1R11-840	1 DF 20 A-6	35
1R11-841	1 DF 23 B-5	45
1R11-843	1 DF 17 B-3	31
1R11-845	1 DF 23 B-2	44
1R11-848	1 DF 20 E-1	38
1R11-850	1 DK 22 E-9 NP	66
1R11-858	1 DF 20 E-2	38
1R11-861	1 DF 19 B-1	32
1R11-862	1 DF 20 A-9	36
1R11-865	1 DF 20 A-10	33
1R11-866	1 DK 21 A-3	57
1R11-867	1 DF 20 A-9	36
1R11-869	1 DF 20 A-10	33
1R11-871	1 DF 20 C-4	37
1R11-878	1 DK 21 A-4 NP	58
1R11-879	1 DF 20 C-4	37
1R11-882	1 DK 21 A-3	57
1R11-890	1 DF 17-1	32
1R11-896	1 DF 20 C-4	37
1R12-092	1 DK 23 K-9082	68
1R12-520	1 DF 23 A-1	42
1R12-520	1 DF 23 A-2	43
1R12-521	1 DF 23 A-3	43
1R12-700	1 DF 25-1 NP	51
1R12-701	1 DK 23 L-27	70
1R12-702	1 DK 23 L-25	70
1R12-703	1 D 23 E-3	18
1R12-709	1 D 23 C-1	18
1R12-710	1 DF 25-3 NP	53
1R12-711	1 DF 25-13	52
1R12-712	1 DF 25-11	52
1R12-713	1 DK 23 L-31	70
1R12-719	1 DK 23 K-28	68
1R12-720	1 D 23 E-2	18
1R12-721	1 DK 23 L-9131	71
1R12-748	1 DK 20 B-1 NP	55
1R12-749	1 DK 20 B-1	55
1R12-760	1 DK 21 B-4	58
1R12-761	1 DK 21 B-5 NP	59
1R12-762	1 DF 22 C-1	42
1R12-763	1 DF 22 C-1 NP	42
1R12-768	1 DF 25-15	53
1R12-801	1 DF 25 B-1 NP	50

ohne Gewähr | without engagement | sans garantie | sin garantia | без участия | bez gwarancji



Springride	PHOENIX	
1R12-809	1 DF 23 A-1	42
1R12-811	1 DF 25 B-1 NP	50
1R12-813	1 DF 23 A-2	43
1R12-814	1 DF 23 A-3	43
1R12-823	1 DF 25 C-1	51
1R12-824	1 DF 25 C-1 NP	51
1R12-825	1 DF 25 C-1	51
1R12-826	1 DF 25 C-1 NP	51
1R12-834	1 DK 21 B-4	58
1R12-837	1 DK 23 L-1	69
1R12-840	1 DK 23 L-1 NP	69
1R12-842	1 DK 23 K-1 NP	68
1R12-849	1 DF 23 A-4	43
1R13-148	1 DK 25-1	71
1R13-150	1 DK 25-1	71
1R13-160	1 DF 23 B-1	44
1R13-199	1 DF 23 C-1	45
1R13-200	1 DF 23 D-1	46
1R13-732	1 DK 28 D-3	72
1R13-734	1 D 28 C-12	24
1R13-738	1 DK 28 F-4	72
1R13-744	1 DF 23 C-1	45
1R13-745	1 DF 23 D-1	46
1R13-746	1 DF 23 B-1	44
1R13-750	1 DF 23 B-4	45
1R13-752	1 DF 23 B-4	45
1R13-753	1 DK 28 F-5	73
1R13-754	1 DF 23 B-4	45
1R13-803	1 DK 28 D-3	72
1R13-805	1 D 28 C-12	24
1R14-700	1 DK 32 L	75
1R14-701	1 DK 32 K	74
1R14-705	1 D 28 B-2	22
1R14-706	1 DK 28 B-7	71
1R14-708	1 DK 32	74
1R14-709	1 D 28 B-4	23
1R14-710	1 D 28 B-12	22
1R14-712	1 DK 32-1	76
1R14-716	1 D 28 A-2	20
1R14-721	1 D 28 B-12	22
1R14-724	1 DK 32 K-1	75
1R14-727	1 D 28 B-9	23
1R14-728	1 D 28 D-10	24

Springride	PHOENIX	
1R14-729	1 D 28 B-10	21
1R14-730	1 D 28 A-10	19
1R14-748	1 DK 32-2	76
1R14-753	1 D 28 H-16	27
1R14-755	1 D 28 H-16 NP	27
1R14-757	1 DK 32 K-2	75
1R14-758	1 D 28 D-2	25
1R14-781	1 DK 32 L-1	76
1R14-782	1 D 28 F-1	26
1R14-783	1 D 28 A-12	20
1R14-784	1 D 28 F-5	26
1R14-809	1 DK 32 E-4	74
1R14-810	1 D 28 F-1	26
1R14-812	1 D 28 F-5	26
1R14-814	1 DF 32-1	53
1R14-819	1 DK 28 F-3	72
1R14-820	1 D 28 A-2	20
1R14-823	1 DK 28 F-3	72
1R14-824	1 D 28 A-2	20
1R14-825	1 D 28 A-13	20
1R14-857	1 D 28 B-2	22
1R14-867	1 D 28 B-5 NP	23
1R14-868	1 D 28 A-5 NP	21
1R14-869	1 D 28 H-17	28
2B12-425/300	2 B 20 R	100
2B9-223	SP 2 B 12 R	108
2B9-234	SP 2 B 12 R-17	109
2B9-269	SP 2 B 12 R-A-10	109
2B9-700	SP 2 B 12 R-5	109
2B9-701	SP 2 B 12 R-A-3	110
2B9-8325	2 B 12 R	100
8017	1 E 21	80
8018	1 E 25	84
8053	1 E 18	78
8117	1 F 32 A	94
9002	1 F 20 A	89
9003	1 F 20 B	89
9004	2 G 20	105
9005	2 G 20 A	105
9006	1 E 26	86
9007	1 E 32	88
9008	1 F 21	91
9009	1 E 21-6	82

ohne Gewähr | without engagement | sans garantie | sin garantia | без участия | bez gwarancji



Springride	PHOENIX	
9011	1 E 26 A	86
9012	1 F 21 C-2	92
9013	1 E 21 D	81
9014	1 E 21 C	81
9015	1 F 21 C-5	92
9048	1 F 16	89
9050	1 E 23	83
9051	1 F 21 A	92
9066	1 F 21 D	93
9073	1 F 26 B-1	93
9074	1 F 26 D	94
9075	1 F 26	93
9077	1 F 26 C	94
9080	1 E 18 D	79
9081	1 E 21 B	81
9082	1 E 18 E	80
9106	1 E 21 E	82
9112	1 E 18 C	78
9113	1 E 23 A	83
9123	1 E 25 B	85
9131	1 E 21 F	82
9133	1 E 18 C	78
9134	1 E 21 F	82
9500	1 E 26-1	88
9502	1 E 18 D-02	79
9505	1 KF 21-1	95
9505	1 KF 21-21	96
9506	1 KF 21-2	96
9506	1 KF 21-22	97
9507	1 KF 21-1 NP	95
9508	1 KF 21-2 NP	96
9513	1 E 18 D-03	80
9517	1 KF 24-1 NP	97
9518	1 KF 24-2 NP	98
9519	1 KF 24-1	97
9519	1 KF 24-21	98
9520	1 KF 24-29	98
9520	1 KF 24-9	99
9529	1 E 26-1	88
9553	1 E 18 D-01	79
9562	1 E 23 A-1	83
ex 1R13-711	1 DK 28 F-4	72

ohne Gewähr | without engagement | sans garantie | sin garantia | без участия | bez gwarancji



Vibracoustic	PHOENIX	
V 1 D 28 D-10	1 D 28 D-10	24
V 1 D 23 E-3	1 D 23 E-3	18
V 1 D 23 G-1	1 D 23 G-1	19
V 1 D 28 A-10	1 D 28 A-10	19
V 1 D 28 A-12	1 D 28 A-12	20
V 1 D 28 A-16	1 D 28 E-1	25
V 1 D 28 A-2	1 D 28 A-2	20
V 1 D 28 A-5 NP	1 D 28 A-5 NP	21
V 1 D 28 B-10	1 D 28 B-10	21
V 1 D 28 B-11	1 D 28 B-11	22
V 1 D 28 B-2	1 D 28 B-2	22
V 1 D 28 B-2 NP	1 D 28 B-5 NP	23
V 1 D 28 B-9	1 D 28 B-9	23
V 1 D 28 C-12	1 D 28 C-12	24
V 1 D 28 D-4	1 D 28 D-2	25
V 1 D 28 F-1	1 D 28 F-1	26
V 1 D 28 F-5	1 D 28 F-5	26
V 1 D 28 F-7	1 D 28 B-12	22
V 1 D 28 G-26	1 D 28 G-26	26
V 1 D 28 H-13	1 D 28 H-13	27
V 1 D 28 H-16	1 D 28 H-16	27
V 1 DF 16 C-1	1 DF 17 A-1	30
V 1 DF 16 D-1	1 DF 17 B-1	30
V 1 DF 16 E-1	1 DF 17-1	32
V 1 DF 16-2	1 DF 16-2	29
V 1 DF 16-2 NP	1 DF 16-2 NP	29
V 1 DF 19 B-1	1 DF 19 B-1	32
V 1 DF 19 B-1 NP	1 DF 19 B-1 NP	33
V 1 DF 20 A-1	1 DF 20 E-1	38
V 1 DF 20 B-1	1 DF 20 D-1	37
V 1 DF 20 C-2	1 DF 20 A-2	34
V 1 DF 20 C-3	1 DF 20 A-3	34
V 1 DF 20 C-4	1 DF 20 A-4	34
V 1 DF 20 D-1	1 DF 20 C-1	36
V 1 DF 22 C-1	1 DF 22 C-1	42
V 1 DF 23 A-1	1 DF 23 C-1	45
V 1 DF 23 A-199	1 DF 23 C-1	45
V 1 DF 23 D-1	1 DF 23 D-1	46
V 1 DF 25 A-1	1 DF 25 A-1	47
V 1 DF 25 A-1 NP	1 DF 25 A-1 NP	47
V 1 DF 25 A-11	1 DF 25 A-11	47
V 1 DF 25 A-12	1 DF 25 A-12	48
V 1 DF 25 A-2	1 DF 25 A-2	48

Vibracoustic	PHOENIX	
V 1 DF 25 A-20	1 DF 25 A-20	48
V 1 DF 25 A-21	1 DF 25 A-21	49
V 1 DF 25 A-22	1 DF 25 A-22	49
V 1 DF 25 A-7	1 DF 25 A-7	50
V 1 DF 25-1	1 DF 25-1 NP	51
V 1 DF 25-11	1 DF 25-11	52
V 1 DF 25-13	1 DF 25-13	52
V 1 DF 25-14	1 DF 25-14	52
V 1 DF 25-15	1 DF 25-15	53
V 1 DF 25-3	1 DF 25-3 NP	53
V 1 DF 32-166252	1 DF 32-1	53
V 1 DK 18-1	1 DK 18 A-1	54
V 1 DK 19-1	1 DK 19-1	54
V 1 DK 20 A-1	1 DK 20 A-1	54
V 1 DK 20 A-51	1 DK 20 A-51	55
V 1 DK 20 B-1	1 DK 20 B-1	55
V 1 DK 20 B-1 NP	1 DK 20 B-1 NP	55
V 1 DK 20 C-2	1 DK 20 C-2	56
V 1 DK 20 C-5	1 DK 20 C-5	56
V 1 DK 21	1 DK 21	56
V 1 DK 21 A-3	1 DK 21 A-3	57
V 1 DK 21 A-31	1 DK 21 A-31	57
V 1 DK 21 A-4	1 DK 21 A-4	57
V 1 DK 21 A-4 NP	1 DK 21 A-4 NP	58
V 1 DK 21 A-8	1 DK 21 A-4	57
V 1 DK 21 A-9	1 DK 21 A-9	58
V 1 DK 21 B-4	1 DK 21 B-4	58
V 1 DK 21 B-5	1 DK 21 B-5 NP	59
V 1 DK 21 K	1 DK 21 K	60
V 1 DK 21 K X 4	1 DK 21 K-1	60
V 1 DK 21 K Y 4	1 DK 21 K-2	60
V 1 DK 21 K-3	1 DK 21 K-3	61
V 1 DK 21 X 1	1 DK 21-1	62
V 1 DK 21 Y 1	1 DK 21-2	62
V 1 DK 22 E-10	1 DK 22 E-11	63
V 1 DK 22 E-13	1 DK 22 E-13	64
V 1 DK 22 E-14	1 DK 22 E-14	64
V 1 DK 22 E-15	1 DK 22 E-15	64
V 1 DK 22 E-5	1 DK 22 E-5	65
V 1 DK 22 E-8	1 DK 22 E-8	66
V 1 DK 22 E-9	1 DK 22 E-9	66
V 1 DK 22 E-9 NP	1 DK 22 E-9 NP	66
V 1 DK 23 B-9	1 DK 23 L-25	70

ohne Gewähr | without engagement | sans garantie | sin garantia | без участия | bez gwarancji

Vibracoustic	PHOENIX	
V 1 DK 23 F-1	1 DK 23 F-1	67
V 1 DK 23 K-28	1 DK 23 K-28	68
V 1 DK 23 K-9082	1 DK 23 K-9082	68
V 1 DK 23 L-25	1 DK 23 L-25	70
V 1 DK 23 L-40	1 DK 23 L-27	70
V 1 DK 23 L-42	1 DK 23 L-31	70
V 1 DK 23 L-6318	1 DK 23 L-1	69
V 1 DK 23 L-9131	1 DK 23 L-9131	71
V 1 DK 25 B-1	1 DK 22 D-1	63
V 1 DK 25 B-2	1 DK 22 D-2	63
V 1 DK 25-8747	1 DK 25-1	71
V 1 DK 28 A-13	1 D 28 A-13	20
V 1 DK 28 B-7	1 DK 28 B-7	71
V 1 DK 28 F-3	1 DK 28 F-3	72
V 1 DK 28 F-4	1 DK 28 F-4	72
V 1 DK 28 F-8	1 DK 28 F-5	73
V 1 DK 28 H-3	1 DK 28 H-3	73
V 1 DK 28 S-672202	1 D 28 H-17	28
V 1 DK 32	1 DK 32	74
V 1 DK 32 E-4	1 DK 32 E-4	74
V 1 DK 32 K	1 DK 32 K	74
V 1 DK 32 K X 11	1 DK 32 K-1	75
V 1 DK 32 K Y 10	1 DK 32 K-2	75
V 1 DK 32 L	1 DK 32 L	75
V 1 DK 32 L X 14	1 DK 32 L-1	76
V 1 DK 32 L-1 NP	1 DK 32 L	75
V 1 DK 32 X 9	1 DK 32-1	76
V 1 DK 32 Y 9	1 DK 32-2	76
V 1 E 10	1 E 10 C	77
V 1 E 14	1 E 14	77
V 1 E 16	1 E 16	77
V 1 E 16-1	1 E 16-1	78
V 1 E 18	1 E 18	78
V 1 E 18 D	1 E 18 D	79
V 1 E 19-1	1 DF 20 G-1	39
V 1 E 19-2	1 DF 20 G-2	40
V 1 E 19-3	1 DF 20 G-4	41
V 1 E 19-4	1 DF 20 G-3	40
V 1 E 20 A	2 F 18	104
V 1 E 21	1 E 21	80
V 1 E 21 D	1 E 21 D	81
V 1 E 21 E	1 E 21 E	82
V 1 E 23	1 E 23	83

Vibracoustic	PHOENIX	
V 1 E 25-5	1 E 25-5	85
V 1 E 25-9	1 E 25-9	86
V 1 E 25(-2)	1 E 25	84
V 1 E 26	1 E 26	86
V 1 E 26 A	1 E 26 A	86
V 1 E 26 A-13	1 E 26 A-13	87
V 1 E 26 A-14	1 E 26 A-14	87
V 1 E 26 A-22	1 E 26 A-14	87
V 1 E 26-1	1 E 26-1	88
V 1 E 26-3	1 E 26-3	88
V 1 E 32	1 E 32	88
V 1 F 16	1 F 16	89
V 1 F 20 A	1 F 20 A	89
V 1 F 20 B	1 F 20 B	89
V 1 F 21	1 F 21	91
V 1 F 21 A	1 F 21 A	92
V 1 F 21 C-2	1 F 21 C-2	92
V 1 F 21 C-5	1 F 21 C-5	92
V 1 F 21 C-6	1 F 20 C	90
V 1 F 21 D	1 F 21 D	93
V 1 F 26	1 F 26	93
V 1 F 26 B-1	1 F 26 B-1	93
V 1 F 26 C	1 F 26 C	94
V 1 F 26 D	1 F 26 D	94
V 1 F 32 A	1 F 32 A	94
V 1 F 32 B	1 F 32 B	95
V 1 KF 21-1	1 KF 21-21	96
V 1 KF 21-1 NP	1 KF 21-1 NP	95
V 1 KF 21-2	1 KF 21-22	97
V 1 KF 21-2 NP	1 KF 21-2 NP	96
V 1 KF 24-1-230	1 KF 24-1	97
V 1 KF 24-1-230 NP	1 KF 24-1 NP	97
V 1 KF 24-1-232	1 KF 24-21	98
V 1 KF 24-2-230	1 KF 24-9	99
V 1 KF 24-2-230 NP	1 KF 24-2 NP	98
V 1 KF 24-2-232	1 KF 24-29	98
V 1 KF 32-23-232	1 KF 32-23	99
V 1 KF 32-23-232 NP	1 KF 32-23 NP	99
V 2 B 07 R	2 B 07 R	100
V 2 B 12 R	2 B 12 R	100
V 2 B 20 R	2 B 20 R	100
V 2 B 20 R-9	2 B 20 R-9	101
V 2 B 34 R	2 B 34 R	101

ohne Gewähr | without engagement | sans garantie | sin garantia | без участия | bez gwarancji



Vibracoustic	PHOENIX	
V 2 B 34 RB	2 B 34 R-B	101
V 2 B 49 RB	2 B 49 R-B	102
V 2 E 18 B	2 E 18 B	103
V 2 E 23	2 E 23	103
V 2 E 23 A	2 E 23 A	104
V 2 G 20	2 G 20	105
V 2 G 20 A	2 G 20 A	105
V SP 2 B 07 R	SP 2 B 07 R	107
V SP 2 B 12 R	SP 2 B 12 R	108
V SP 2 B 12 R-1	SP 2 B 12 R-1	108
V SP 2 B 12 R-5	SP 2 B 12 R-5	109
V SP 2 B 12 RA-10	SP 2 B 12 R-A-10	109
V SP 2 B 12 RA-3	SP 2 B 12 R-A-3	110
V SP 2 B 34 R	SP 2 B 34 R	111

ohne Gewähr | without engagement | sans garantie | sin garantia | без участия | bez gwarancji

www.phoenix-airsprings.com

Certification in the ContiTech Air Spring Systems business unit

IATF 16949
ISO 9001
ISO 14001



Please visit our online catalog: <https://www.phoenix-airsprings.com/en/catalog/>
Here you always find up-to-date information.



ContiTech Luftfedersysteme GmbH
Philipsbornstr. 1
30165 Hannover
Phone +49 (0)511-938 5268
airspring_replacement@continental.com
ContiTech Service worldwide
www.continental-industry.com

ContiTech Hungary Ltd.
Derkovits u. 137
HU-4400 Nyíregyháza

The content of this publication is provided for information only and without responsibility. ContiTech Deutschland GmbH obligations and responsibilities regarding its products are governed solely by the agreements under which the products are sold. Unless otherwise agreed in writing, the information contained herein does not become part of these agreements. This publication does not contain any guarantee or agreed quality of ContiTech Deutschland GmbH products or any warranty of merchantability, fitness for a particular purpose and non-infringement. ContiTech Deutschland GmbH may make changes in the products or services described at any time without notice. This publication is provided on an "as is" basis. To the extent permitted by law, ContiTech Deutschland GmbH makes no warranty, express or implied, and assumes no liability in connection with the use of the information contained in this publication. ContiTech Deutschland GmbH is not liable for any direct, indirect, incidental, consequential or punitive damages arising out of the use of this publication. Information contained herein is not intended to announce product availability anywhere in the world. © 2023 ContiTech Deutschland GmbH. All rights reserved.

